



[VIEW CONTENTS](#)

# Hose, Fittings and Equipment

Catalog 4400 October 2022



ENGINEERING YOUR SUCCESS.

# Parker Hannifin – the global leader and your partner



*With annual sales exceeding \$13 billion, Parker Hannifin is the world's leading diversified manufacturer of motion and control technologies and systems, providing precision-engineered solutions for a wide variety of mobile, industrial and aerospace markets. Our products are vital to virtually everything that moves or requires control, including the manufacture and processing of raw materials, durable goods, infrastructure development and all forms of transport.*

Within Parker's seven operating groups, the company's engineering expertise spans the core motion technologies – electromechanical, hydraulic and pneumatic – with a full complement of fluid handling, filtration, sealing and shielding, climate control, process control and aerospace technologies.

The leader in “dry technology” for the fluid power industry, Parker's Fluid Connectors Group is your single source for high-quality tube fittings, hose and hose fittings, thermoplastic tubing, brass fittings and valves, quick-disconnect couplings and assembly tools. The Fluid Connectors Group serves customers in a broad range of markets, including Aerial Lift, Agriculture, Bulk Chemical Handling, Construction Machinery,

Food & Beverage, Fuel & Gas Delivery, Industrial Machinery, Medical, Mining, Mobile, Oil & Gas and Transportation. Products are available for shipment 24 hours a day, supported by 49 manufacturing facilities throughout the world, a global distribution network and 25 company-owned stocking service centers. Our commitment to you is impeccable customer service. To meet your specific requirements, we offer a broad range of programs designed to reduce your overall operating costs, streamline manufacturing, improve productivity, manage inventory, enhance delivery and address safety and environmental issues. For value-added services that generate value-added solutions, team up with Parker!



# Hose Products Division

Low, Medium, High and Ultra Pressure Hose



Parkrimp® Assembly Equipment



Field Attachable Fittings



Custom Hose Assemblies and Hose Fittings



Parkrimp® Permanent Hose Fittings



Parker Tracking System



Accessories



*With a long history of providing premier customer service, Hose Products Division is the leading manufacturer of hose, fittings and crimping technology for industrial and hydraulic markets. Continually expanding our products to better serve the market, we offer world-class service technologies including the Parker Tracking System, Onsite containers and rapid prototyping. Our division headquarters in Wickliffe, Ohio, is our precision-engineered-solution center for products, materials and processes, and is equipped with state-of-the-art development, testing and performance technology. Hose Products Division has several manufacturing locations within the United States dedicated to delivering a quality product on time. Knowing that uptime and productivity are major drivers in your business success, we proudly present our new catalog outlining Parker's best-in-class hose products and services.*

*Best regards,*

*Ben Mather  
General Manager*

## PARKER SAFETY GUIDE FOR SELECTING AND USING HOSE, TUBING, FITTINGS AND RELATED ACCESSORIES



# WARNING

**FAILURE OR IMPROPER SELECTION OR IMPROPER USE OF HOSE, TUBING, FITTINGS, ASSEMBLIES OR RELATED ACCESSORIES (“PRODUCTS”) CAN CAUSE DEATH, PERSONAL INJURY AND PROPERTY DAMAGE. POSSIBLE CONSEQUENCES OF FAILURE OR IMPROPER SELECTION OR IMPROPER USE OF THESE PRODUCTS INCLUDE BUT ARE NOT LIMITED TO:**

- Fittings thrown off at high speed.
- High velocity fluid discharge.
- Explosion or burning of the conveyed fluid.
- Electrocutation from high voltage electric powerlines.
- Contact with suddenly moving or falling objects that are controlled by the conveyed fluid.
- Injections by high-pressure fluid discharge.
- Dangerously whipping hose.
- Contact with conveyed fluids that may be hot, cold, toxic or otherwise injurious.
- Sparking or explosion caused by static electricity buildup or other sources of electricity.
- Sparking or explosion while spraying paint or flammable liquids.

Before selecting or using any of these products, it is important that you read and follow the instructions below. Only hose from Parker's Stratoflex Products Division is approved for in flight aerospace applications, and no other hose can be used for such in flight applications.

Parker Publication No. 4400-B1 Revised 2007

## DO NOT MIX & MATCH

### **DO NOT MIX & MATCH –**

Components from different manufacturers should not be combined to create hose assemblies (apart from rare instances when both manufacturers have approved the exception). To mix and match components is to increase the risk of hose failure – a dangerous situation regardless of setting or application. Possible consequences of hose failure resulting from the use of incompatible components include:

- **Fittings thrown off at high speed**
- **High velocity fluid discharge**
- **Fluid injection injury**
- **Violently “whipping” hose**
- **Sparking or explosion from sprayed flammable fluids**
- **Suddenly moving / falling objects otherwise held static by fluid pressure**
- **Only assemble hoses and fittings of the same make**
- **Always use a crimper approved by the manufacturer of the hose and fittings**
- **Crimp only to the manufacturer's specification**

The individual is solely responsible for the hose assemblies he or she fabricates. Fluid power professionals should abide by three basic tenets when fabricating hose assemblies:

Parker's recommendations are consistent with SAE standard J1273: *Industry Consensus on Best Practices for Using Hydraulic Hose*. The complete technical paper, which includes SAE-recommended practices for hose assembly fabrication, can be purchased from [www.SAE.org](http://www.SAE.org).

# Table of contents



Constant Working Pressure  
Hydraulic - Industry Standard  
Suction and Return  
Push-Lok®  
Phosphate Ester  
Low Temperature  
Transportation  
Alternative/Marine Fuel  
Refrigerant

Hose A



Parkrimp (crimp)  
Field Attachable

Fittings B



Parkrimp Crimpers  
Die Selection Charts  
Pumps  
Hose Assembly Equipment

Equipment C



Flange Adapters and Kits  
O-Rings  
Hose Guards  
Clamps  
Workstations

Accessories D



Size  
Temperature  
Application  
Media  
Pressure Information  
  
Part Number Index  
Safety Guide

Technical E

# Hose Products Division – the market leader and your supplier of choice



## Put a bite on the braid.

Parker's world-recognized tiger mascot has represented the Parkrimp No-Skive hose assembly program since its introduction in 1980. In a contest originally held by our marketing department, the tiger was the winning suggestion over three others: a turtle (deemed "too slow"), an alligator ("not very good looking") and a shark ("too intimidating" particularly at the time of the release of the movie *Jaws*).

More than three decades later, the tiger graphic still supports the Parkrimp message everywhere, clearly symbolizing our unique, patented Parkrimp fittings with tapered steel teeth and our Parkrimp crimping machines. Their ability to eliminate hose cover skiving and achieve the metal-to-metal grip of factory assemblies revolutionized the process for markets worldwide. And today, it's the industry standard.

Pride in our products: At Parker, we believe the best fluid connector products for your operation are the ones that get the job done right. We offer the most comprehensive line of hoses, fittings, equipment and accessories you'll need. And if there's something you need that's not a standard product, we're able to design and manufacture it for you with ease.

You'll also benefit from our ultimate competitive advantage – our network of distribution outlets that can provide our products nearly anytime and anywhere. We strive to provide customers with local engineering, local products and local service.

Parker offers the largest selection of hoses plus more fitting sizes than any other manufacturer. You'll find a wide variety of hoses including braided, spiral and multi-purpose, and more than 4,500 Parkrimp fittings. Parker products have been designed, tested and approved to meet and exceed global standards.



The right product is available for your application, including hose that features a variety of abrasion-resistant cover choices, flexibility, a wide range of media compatibility and more – characteristics that make Parker the hose supplier of choice for customers that demand the most from their equipment.



# Made in the U.S.A. – serving the world

*In an ever changing global business environment, all applications are not created equal. We can help you specify solutions in order to make informed purchasing decisions around technology, applications and relevant specification requirements. When you buy from Parker, you are getting a Parker designed hose made worldwide within our own*

*factories, assembled by Parker employees. Therefore, Parker can promise premier customer service, high quality manufacturing standards, on-time delivery and a culture of continuous improvement so you remain competitive in the marketplace and achieve growth objectives.*



## Global Availability

Parker hoses are manufactured in the major regions of the world – North America, Europe and Asia – supporting the equipment and customers we serve. Our worldwide reach makes it easier to specify and source through our unrivaled industrial distribution network of 13,000 locations worldwide. We strive to provide customers with local engineering, quality products and premier services on a global level.

Standard cover, while our SuperTough cover is 450 times more abrasion resistant offering unparalleled protection from abrasive environments.



are easier to handle, requiring fewer man-hours for installation and repair.



A smaller bend radius lets designers place key components – such as pumps and valves – closer together, so systems can be more compact. This gives engineers more freedom in configuring equipment with less hose. As a result of our designs, the force to flex or the force re-

quired to put the hose in its minimum radius is the lowest in the industry. The force to flex directly affects employee fatigue, risk of injury and ease of installation.



## Extended Hose Life

Consistency in product performance starts with consistent materials. Parker's materials development laboratory uses the latest technology to evaluate products under various conditions. Hose construction style as well as cover type has a direct impact on hose life and safety. For instance, our spiral hose has two times the impulse life, which reduces material and labor costs.



## Innovative Design

Today there is a tremendous amount of pressure to adjust with the continuously evolving application requirements in terms of available space, performance, and production efficiency. Parker responded with the development of higher temperature resistant hoses, increased pressure ranges, longer impulse life and improved abrasion resistance to meet these increasing requirements.

Our hose has a smaller outside diameter, weighs less, and is more flexible, which simplifies installation. This can lead to smaller and lighter cable tracks



## Specifications

All of our hoses meet or exceed various industry specifications including SAE, EN, DIN, or ISO. Many of our new hoses are designed to meet the ISO 18752 specification, which enables customers to choose a hose by pressure range, not construction. Hoses in this product family simplify the specification process as well as reduce compliance complexity on a global platform.



Parker hoses come in a variety of cover options so you can match the right cover to your application. Our ToughCover is 80 times more abrasion resistant than our



# Services – easy to do business with



## PARKER TRACKING SYSTEM (PTS)

Parker Tracking System (PTS) is an innovative component-tagging and asset management solution. In addition to labeling components, users can document, replace, track, inspect, plan and analyze key equipment data with PTS.

[www.parker.com/pts](http://www.parker.com/pts)



## PARKERSTORE

ParkerStores are a global network of independently-owned industrial retail operations with more than 3,500 service points around the world. Whether it's through a brick-and-mortar location or from one of our mobile Hose Doctor operators, Parker is your best bet for on-the-job help.

[www.parkerstore.com](http://www.parkerstore.com)



## HOSE CLEANING SERVICES

Parker offers hose cleaning services in order to protect the life of hose assemblies from dirt and debris, which can cause unwanted hose failures. A pellet flushing system is used after hoses are cut and crimped to remove debris from inside the assembly. To ensure cleanliness, we recommend utilizing Parker Clean Seal Caps. Both the pellets and the caps are an easy and quick way to ensure you have a contamination-free hose assembly.

[www.parkerhose.com](http://www.parkerhose.com)



## CUSTOM MANUFACTURING OPERATION & RAPID SERVICE UNIT

When the situation calls for a custom product or special single piece, the experts at Parker's Hose Products Division can create a solution specific to your needs.

Parker's Custom Manufacturing Operation and Rapid Service Unit can produce a single, critical piece or several in as little as 24 hours.

[www.parker.com/rsu](http://www.parker.com/rsu)



## TUBE ASSEMBLIES & HOSE TUBE COMBINATIONS

Parker's tube assemblies or hose and tube combinations provide an alternative to rubber hose. Tube assemblies are a viable alternative in some applications where the port to port mounting is consistent and where the vibration and movement is limited. All assemblies are custom made to your specifications. Parker is ideally suited to supply high volume assemblies for equipment manufacturers but can also supply for quantities as small as five. For more information, please call:

**440-943-5700.**



# Continuously developing ways to serve our customers

## CRIMPSOURCE

To help you with your equipment, Parker provides an exclusive online software application: CrimpSource. CrimpSource supplies you with the necessary crimp specifications in order to adhere to our strict safety standards. It is the industry's most complete resource for crimper technical information. It provides easy access to all the specifications necessary to correctly fabricate a factory-quality hose assembly. With a series of dropdown menus, users are able to choose a crimper, the type of hose, and compatible fittings. Once the crimper is selected, the user is provided with crimp specs, crimper die recommendations, technical manuals, and crimper decals available for immediate printing.

**[www.parker.com/crimpsource](http://www.parker.com/crimpsource)**.



## KITTING

Want to speed up assembly on the factory floor? Parker custom kits might be just what you're looking for. From fittings and adapters to pre-made assemblies, custom kits can hold a wide range of materials, in the exact order and quantities you need. What's the advantage? Streamlined procedures. Quicker assembly. Lower costs. And a single part number for easier processing.



## VENDOR MANAGED INVENTORY

Enjoy a customized program where Parker personnel can manage your inventory in person or remotely. Reduce overall inventory, increase your inventory turns and increase your efficiency.



## BREADMAN

Lean logistics and delivery of Parker products and kits directly to the customer's assembly line, work station or warehouse.

- 100% parts availability minimizes downtime, increases production and reduces costs
- Elimination of stock checking reduces manpower and maintains production levels
- Daily delivery reduces inventory and overheads
- Electronic order processing eliminates paperwork and reduces administration costs



## CAD

By making thousands of CAD files available, Parker provides its customers with the resources to do more.

**[www.parker.com/HPD\\_CAD](http://www.parker.com/HPD_CAD)**



# Parker Tracking System

## Increasing the speed, timing, and accuracy of your next replacement

Parker Tracking System (PTS) is an innovative component-tagging and asset management solution offered by Parker and our business partners in over 62 countries worldwide. Today's equipment and machines are more connected than ever before and harnessing this complex data is key to maximizing up-time. By focusing on critical-wear components, Parker drives new levels of productivity, efficiency, and reliability.

### Uptime is everything

Record, manage and retrieve critical asset information with PTS. This innovative system provides fast and accurate product information, speeding replacement regardless of where or when the original component was created. Because tagged products can be replaced sight unseen, PTS eliminates the need to wait for removal before new parts can be acquired. Reducing transaction time, means users can realize significant gains in productivity and equipment uptime.

### Business system integration

Maintenance, Repair and Operations (MRO) can be greatly enhanced by customizing PTS and integrating it into existing systems. With seamless data integration, Parker enables bi-directional transfer of critical data to maximize asset visibility and performance. For details on supported platforms and protocols, contact a member of our team.

### Global power, local reach

PTS works seamlessly around the world. Whether you sell, service or operate products and equipment in one city, one state or worldwide, PTS can be tailored to your needs. Equipment built in one country that is sold and serviced in another can use PTS to deliver accurate product details wherever and whenever they are needed. To support our global footprint, PTS offers translation in multiple languages.



### Maintenance and inspection

Industry and governmental regulations are driving businesses to be more aware of their own record keeping. The PTS Pro Service Plan enables users to establish inspection and/or replacement dates to drive proactive maintenance planning.

With PTS Pro, users can realize greater equipment utilization and ensure compliance with a variety of safety and maintenance programs.

Parker offers tagging media that has been tested and engineered to excel in rugged applications, including extreme temperatures, UV, salt spray, xenon arcing, and submersion in many fluids such as fuel, Skydrol®, and salt water. A product specialist can help select a tagging solution that is perfect for you.

# Simple. Durable. Powerful.

## Tagging solutions for every application

PTS makes producing clear and dynamic product identification tags a breeze. PTS marking provides a critical link to the digital record where product-specific data is stored. Along with durable labels, RFID and other tagging media are available.

### Reporting

Robust reporting tools can provide data for engineering, quality, and sales to analyze for a better understanding of component part performance. Customized reports can be exported for further analysis.

### Operational efficiency

OEMs can use custom data fields to produce labels with assembly instructions to help ensure correct components get delivered to the appropriate manufacturing cell or machine. This custom label data can also be used to direct customers on spare part replacement when required.

### How PTS works:

- PTS labels are customized with specific assembly information and attached to the hose when the assembly is made.
- When the assembly requires replacement, simply call your local distributor with your PTS number, or call 1-800-C-Parker to find an authorized distributor near you.
- The distributor can create an exact replacement of your hose assembly and either ship it to you or have it ready to pick up once you arrive. Distributors can also scan your hose label in-store.
- Data is collected about your failure which may help us in recommending different components or accessories designed to get the most from your machine or equipment.

PTS labels are specifically engineered to withstand harsh chemicals, temperatures, UV exposure and other challenging conditions.

Visit [www.parker.com/pts](http://www.parker.com/pts) for more information.

Within an OEM operation, barcodes representing PTS IDs and customer part numbers speed data entry. Date marking on each label verifies the manufacture date by providing key information for warranty, inspection or maintenance planning purposes.

### Compliance

PTS can help deliver compliance with a number of industry accreditations such as ISO 9001 and ISO 17165-1. We also support requirements from The Energy Institute, DNV, and other regulatory bodies.



# The Parker Fluid Connectors Group

## Take advantage of our connections

Need help with the big picture? Turn to Parker. As part of the Fluid Connectors Group, we have everything to keep the ideas flowing.

### Innovative products

We manufacture highly engineered components and systems that facilitate motion and the controlled flow of liquids and gasses for a wide variety of global markets to increase our customers' productivity and profitability. From flying aircraft and building infrastructure; to

developing more efficient energy, advancing medical science and engineered materials, providing clean food and water, and supporting military efforts; Parker's Fluid Connectors Group

brings it all together, partnering with our customers to help solve some of the world's greatest engineering challenges.



### Global reach

Parker's global footprint is supported by an unrivalled industrial distribution network extending to approximately 13,000 locations around the world. Through this extensive network of local, independent businesses, Parker brings its products and services to customers in 104 countries.

### Mobile services

Parker is your best bet for on-the-job help. Our mobile services operate 24 hours a day, 7 days a week, to arrive at your plant or job site fast. Complete with factory-trained professionals to troubleshoot your problem. Our mobile vans carry a full complement of hose, all major fitting configurations, and a complete set of metrics —

everything that's needed to create a replacement. It's like having your Parker distributor come to you! Find out more at [parker.com/distributors](http://parker.com/distributors).

## ParkerStore Onsite mobile work containers

To provide expert service even in the most remote job site locations, the ParkerStore Onsite Program delivers a fully customized mobile workspace directly to your job site. These highly efficient and mobile container-based work sites provide all the technology, equipment and inventory needed for remote fabrication of hose and tube assemblies, and much more.

The ParkerStore Onsite container solution will significantly reduce the time it takes to obtain critical spares or fabricate replacement hose assemblies. Equipment and labor downtime are greatly reduced, keeping your operations up and running longer. Find out more at [www.parker.com/onsite](http://www.parker.com/onsite).

## ParkerStores

ParkerStores provide walk-in customers with the ability to personally select the parts they need in a retail environment. Customers can see, touch, and feel the parts they're considering, and talk directly to staff when advice is needed. With more than 2,200 locations in more than 90 countries, ParkerStores are yet another way customers can get in, get out, and get going. Find out more at [www.parkerstore.com](http://www.parkerstore.com).



Cargo Doors



Storage Racks and Cabinets



Full Electrical Service



Security Doors



Heating/Cooling



Rugged Lighting Service



# Parker testing facilities

## Assuring superior quality and performance

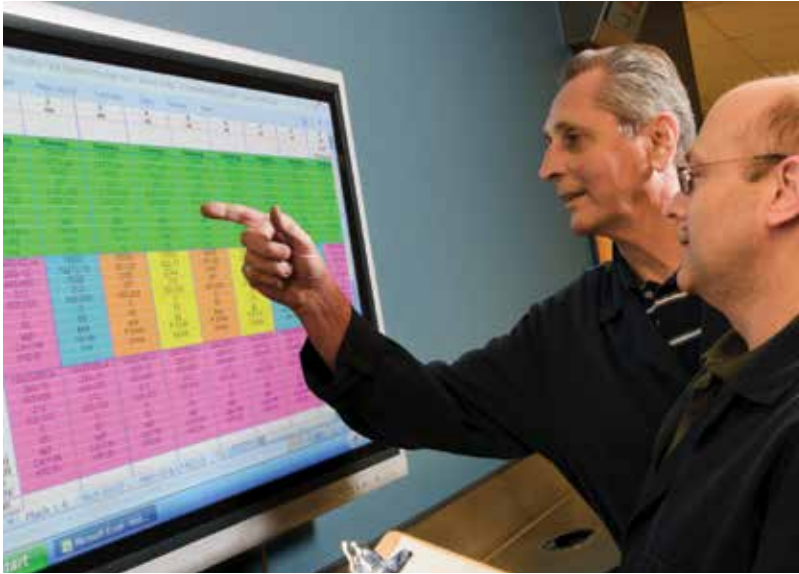

Multiple test capabilities and the latest testing technology combine to assure the integrity of Parker products globally.

Putting designs to the test, our world class development and test capabilities assure our customers of world-class quality and performance. In the field or in our advanced development and test facility, Parker is unsurpassed in both technical knowledge and testing capabilities. With the latest in technology, our state-of-the-art materials development and performance test labs are capable of determining baseline engineering and design properties. Additionally, we simulate application and environmental conditions encountered every day, both common and complex, assuring the integrity of Parker products designed to meet your needs.

Consistency in product performance starts with consistent materials. Parker's materials

development laboratory uses the latest technology in equipment and methods to evaluate the behaviors of elastomeric materials under varying conditions. Our in-house capability assures the materials in our design are engineered to withstand the extremes of application and the environment, time after time, every time.

With specialized skills, and time-tested experience, Parker engineers have built an impressive record of problem solving for our customers. We understand the importance of product selection, designed and tested to meet your unique demands. And our customers understand the value of our solutions.

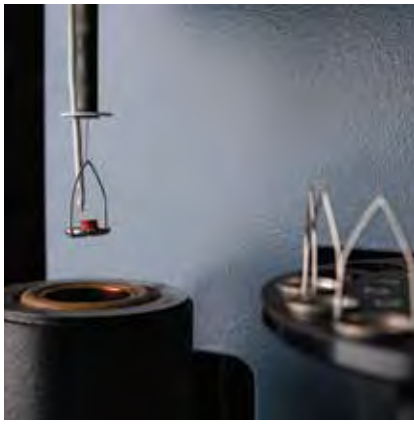

Thermogravimetric analyzer

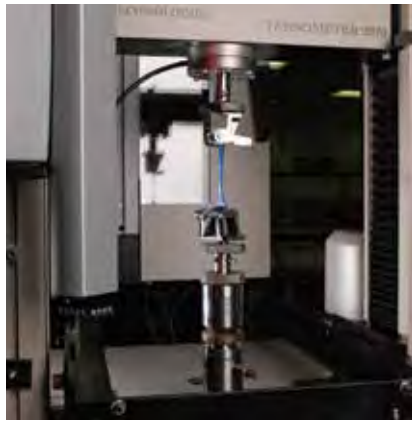

Tensometer



Soxhlet extraction



Salt spray test



Rubber mixing

Burst Pressure Test (*below*)  
Using our state-of-the-art testing and performance technology in our precision-engineered-solutions center, we continuously look to better serve our customers by ever improving our products.



# Before you spec it, STAMP it

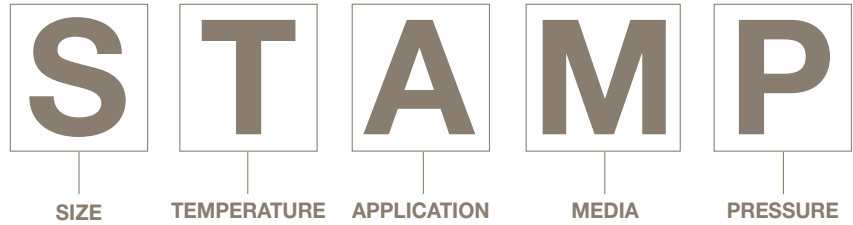

When you order hose and fittings from Parker, remember the word “STAMP.” That way you won’t forget important information!

## Size

Parker uses a system of measurement called Dash Numbers to indicate hose and fitting size. The dash number, or dash size, is the measure of a hose’s Inner Diameter (I.D.) in sixteenths of an inch. (The exception to this is SAE 100R5 hose. See the chart below for complete details.)

diameter measured. Be sure to measure the overall assembly length and fitting orientation before cutting the hose.

The hose I.D. must be sized accurately to obtain the proper flow velocity. A flow that’s too slow results in sluggish system performance, while a flow that’s too high causes excessive pressure drops, system damage, and leaks.

Use the Flow Capacity Nomogram in Section E to determine the proper hose I.D. for an application’s flow rate requirements.

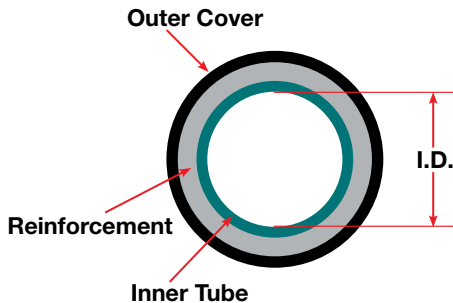

This measuring system of the inside diameter of the hose is universally used by the fluid power industry today. Don’t know the hose size? Check the layline. If the original printing has worn off, the original hose must be cut and the inside

The hose size is determined by the inside diameter which can be measured or found on the layline.

Dash No.	Hose I.D. (Inches)			
	All Except Transportation and Refrigerant Hoses		Transportation and Refrigerant Hoses	
	Inches	Millimeters	Inches	Millimeters
-3	3/16	5	–	–
-4	1/4	6,3	3/16	5
-5	5/16	8	1/4	6,3
-6	3/8	10	5/16	8
-8	1/2	12,5	13/32	10
-10	5/8	16	1/2	12,5
-12	3/4	19	5/8	16
-16	1	25	7/8	22
-20	1-1/4	31,5	1-1/8	29
-24	1-1/2	38	1-3/8	35
-32	2	51	1-13/16	46
-40	2-1/2	63	2-3/8	60
-48	3	76	3	76





## Temperature

When specifying hose, there are two temperatures you need to identify. One is the ambient temperature, which is the temperature that exists outside the hose where it is being used; the other is the media temperature, which is the temperature of the media conveyed through the hose.

Very high or low ambient temperatures can have adverse effects on the hose cover and reinforcement materials, resulting in reduced service life.

Media temperatures can have a much greater impact on hose life. For example, rubber loses flexibility if operated at high temperatures for extended periods.

Parker hoses carry different temperature ratings for different fluids. For example, 811HT hose has a temperature range of -40°F to + 257°F (-40°C to +125°C) for petroleum-based hydraulic fluids. However for water, water/glycol, and water/oil emulsion hydraulic fluids, the range drops to a rating of up to +185°F (+ 85°C). Air is rated even lower at up to 158°F (+ 70°C).

Some media can increase or decrease the effects of temperature on the hose. The maximum rated temperature of a hose is specific to the media. See the Minimum/Maximum Temperature Chart in Section E for a full listing of all temperature ratings.



## Application

Before selecting a hose, it is important to consider how the hose assembly will be used. Answering the following questions may help:

- **What type of equipment is involved?**
- **What are the environmental factors?**
- **Are mechanical loads applied to the assembly?**
- **Will the routing be confined?**
- **What about hose fittings – permanent or field attachable?**
- **Will the assembly be subjected to abrasion?**

Sometimes specific applications require specific hoses. For example, applications where hoses will encounter rubbing or abrasive surfaces, would be best

handled by our family of abrasion-resistant hose with both Tough and Super Tough covers.

When application space is tight, bend radius is another important consideration. Parker offers a full line of hoses designed for one-half SAE bend radius at full SAE-rated pressures. We offer hoses with increased flexibility and smaller outer diameters enabling faster, easier routing in small spaces, reducing both hose length and inventory requirements.

Industry standards set specific requirements concerning construction type, size, tolerances, burst pressure, and impulse cycles of hoses. Parker hydraulic hoses meet or exceed standards such as:

- **SAE (Society of Automotive Engineers)**
- **EN (European Norm)**
- **DIN (Deutsches Institut für Normung)**
- **ISO (International Organization for Standardization)**



Governmental agencies control additional standards for particular industries such as U.S.C.G. and ABS. You must select a hose that meets the legal requirements as well as the functional requirements of the application.

Media		Chemical Resistance Information (page E-38)									
<p><b>Warning:</b> The chemical compatibility guide shown on this page is for information only. It does not constitute a warranty. The user must consult the manufacturer's literature for the most current and complete information.</p>											
Media	Material	Acid	Alkali	Alcohol	Ammonia	Antifreeze	Brake Fluid	Grease	Hydraulic Oil	Mineral Oil	Water
A	Acrylic	✓	✓	✓	✓	✓	✓	✓	✓	✓	✓
B	Aluminum	✓	✓	✓	✓	✓	✓	✓	✓	✓	✓
C	Aluminum Oxide	✓	✓	✓	✓	✓	✓	✓	✓	✓	✓
D	Aluminum Oxide	✓	✓	✓	✓	✓	✓	✓	✓	✓	✓
E	Aluminum Oxide	✓	✓	✓	✓	✓	✓	✓	✓	✓	✓
F	Aluminum Oxide	✓	✓	✓	✓	✓	✓	✓	✓	✓	✓
G	Aluminum Oxide	✓	✓	✓	✓	✓	✓	✓	✓	✓	✓
H	Aluminum Oxide	✓	✓	✓	✓	✓	✓	✓	✓	✓	✓
I	Aluminum Oxide	✓	✓	✓	✓	✓	✓	✓	✓	✓	✓
J	Aluminum Oxide	✓	✓	✓	✓	✓	✓	✓	✓	✓	✓
K	Aluminum Oxide	✓	✓	✓	✓	✓	✓	✓	✓	✓	✓
L	Aluminum Oxide	✓	✓	✓	✓	✓	✓	✓	✓	✓	✓
M	Aluminum Oxide	✓	✓	✓	✓	✓	✓	✓	✓	✓	✓
N	Aluminum Oxide	✓	✓	✓	✓	✓	✓	✓	✓	✓	✓
O	Aluminum Oxide	✓	✓	✓	✓	✓	✓	✓	✓	✓	✓
P	Aluminum Oxide	✓	✓	✓	✓	✓	✓	✓	✓	✓	✓
Q	Aluminum Oxide	✓	✓	✓	✓	✓	✓	✓	✓	✓	✓
R	Aluminum Oxide	✓	✓	✓	✓	✓	✓	✓	✓	✓	✓
S	Aluminum Oxide	✓	✓	✓	✓	✓	✓	✓	✓	✓	✓
T	Aluminum Oxide	✓	✓	✓	✓	✓	✓	✓	✓	✓	✓
U	Aluminum Oxide	✓	✓	✓	✓	✓	✓	✓	✓	✓	✓
V	Aluminum Oxide	✓	✓	✓	✓	✓	✓	✓	✓	✓	✓
W	Aluminum Oxide	✓	✓	✓	✓	✓	✓	✓	✓	✓	✓
X	Aluminum Oxide	✓	✓	✓	✓	✓	✓	✓	✓	✓	✓
Y	Aluminum Oxide	✓	✓	✓	✓	✓	✓	✓	✓	✓	✓
Z	Aluminum Oxide	✓	✓	✓	✓	✓	✓	✓	✓	✓	✓

Chemical Resistance information on page E-38.

# Media

What will the hose convey? Some applications require the use of specialized oils or chemicals. The hose you order must be compatible with the medium being conveyed. Compatibility must cover the inner tube, the cover, hose fittings, and o-rings as well. Use the

Chemical Resistance Chart found in Section E to select the correct components of the hose assembly that will be compatible with your system's media. The chart contains the chemical resistance rating of a variety of fluids.



**Hose Hint**  
 For long service life and leak-free functionality, it is vital that the hose assembly be chemically compatible with both the fluid being conveyed through the hose as well as the environment of the hose.

## Pressure

When considering hose pressure, it's important to know both the system working pressure and any surge pressures and spikes.

Hose selection must be made so that the published maximum working pressure of the hose is equal to or greater than the maximum system pressure. Surge pressures or peak transient pressures in the system must be below the published maximum working pressure for the hose.

Each Parker hose has a pressure rating which can be found on the Hose Overview Chart on page A-6, to A-7 and in Section E.

All Parker hydraulic hoses have passed the industry rated specifications for burst pressure and carry a 4:1 design factor unless otherwise noted. Burst pressure ratings for hose are for manufacturing test purposes only. They are not an indication that the product can be used above the published maximum working pressure. It is for this reason that the burst pressure ratings have been removed from the hose charts within the catalog.

Care must also be taken when looking at the “weakest link” of the hose assembly. A hose assembly is rated at the maximum working pressure of the hose and the fitting component. Therefore the maximum working pressure of the hose assembly is the lesser of the rated



To mix and match components is to increase the risk of hose failure – a dangerous situation regardless of setting or application.

working pressure of the hose and the end connections used.

*Here is an example:* An F471TC0101040404-60” hose assembly (which consists of 471TC-4 hose and two 10143-4-4 fittings) would have a maximum working pressure of the lesser of the three components. In this case the fittings have a 12,000 psi rating. The hose has a 5,800 psi rating. Therefore the maximum pressure rating of the hose assembly would be 5,800 psi. Pressure ratings for each Parker end connection can be found on the Pressure Rating of Hose End Connections – PSI Chart in Section E.

Pressure spikes can occur during machine operation in an instant. They can occur so quickly in fact, that standard glycerin filled gages will never detect them. Using a pressure diagnostic system like Parker’s SensoControl can help detect how often and how drastic these pressure spikes are. Contact your Parker representative today.



Hose Overview page A-6 to A-7.

Pressure Rating of Hose End Connections page E-47.

# Hose basics

## Everything you need to know

### Hose Hint

Use the layline of the hose as a visual index when routing and tightening the assembly to ensure the hose is not twisted or kinked.

### It's all in the family

At Parker, we believe the best hose for your operation is the one that gets the job done right — no more, no less. That's why we offer you a comprehensive line of hoses, as well as all the options that go with it. Worried about price?

### Abrasion? We've got you covered

Our expanded line of abrasion-resistant hose offers you a world of protection, not to mention a choice of covers: Tough Cover (TC) for tough environments; and SuperTough (ST) for the really rough stuff.

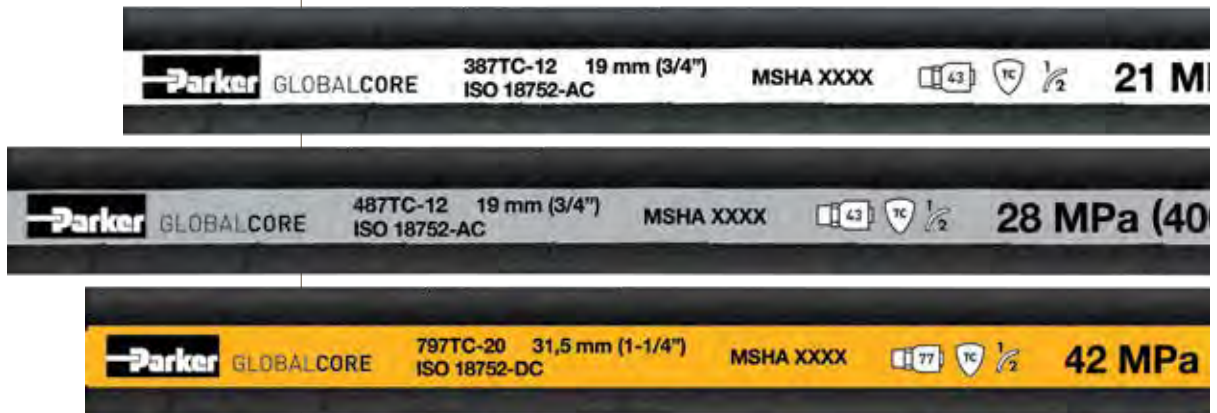



We've got rubber hoses that are an exceptional value. Need hose that can take the heat? We've designed hoses for that. Looking for hose to handle the most demanding conditions? No problem. We have hoses made specifically for high temperatures, tight bending, abrasive environments, and more.

Not sure what hose you need? Talk to our experts. They're trained to know, and they're happy to help.

Our TC- and ST-covered hoses can simplify your assemblies by eliminating the need for any additional protective sleeving.

From the superior flexibility and tighter bend radius of our wire-braided hoses... to the wide fluid compatibility and high pressure performance of our No-Skive spiral hoses... our expanded family of abrasion-resistant hoses gets the job done right, giving you the results you need in the construction, forestry, mining, injection molding, refuse and recycling, and energy industries.

Metal-to-Hose Abrasion Resistance Comparison	
Levels of Abrasion Resistance	Results from the ISO 6945 metal-to-hose abrasion test show that Tough Cover and Super Tough cover hoses offer significantly greater abrasion resistance than standard rubber cover hose.
	<div style="border: 1px solid black; padding: 2px; display: inline-block;">Standard Rubber Cover</div> <div style="border: 1px solid black; padding: 2px; display: inline-block; margin-left: 20px;"><b>80 X</b> Tough Cover (TC)</div> <div style="border: 1px solid black; padding: 2px; display: inline-block; margin-left: 20px;"><b>450 X</b> Super Tough (ST) Cover</div>

Optional Covers	
Type	Features
Tough Cover (TC) 	Very good abrasion resistance. Fair resistance to ozone and cold flexibility.
Super Tough (ST) 	Excellent abrasion resistance. Very good resistance to ozone and cold flexibility.

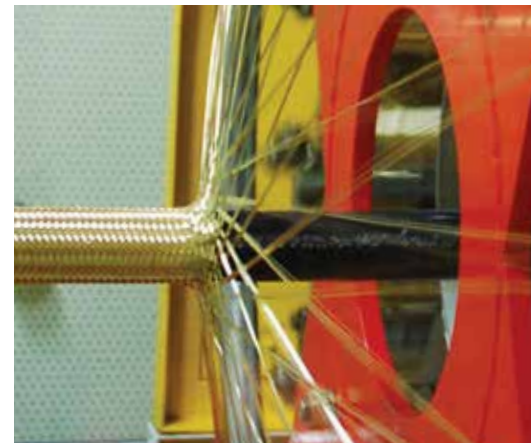
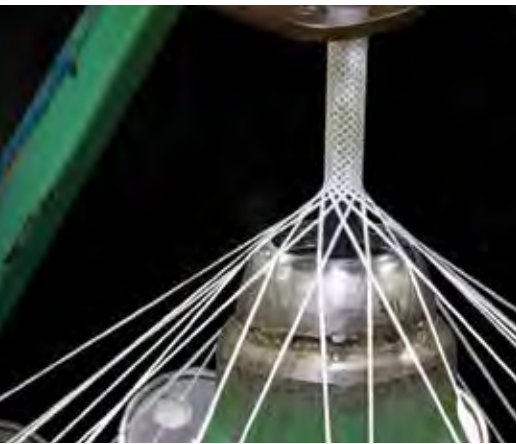

## Braided vs. spiral hose

Hydraulic hose can be referred to by construction style, of which there are two main types: braided and spiral. The majority of “low-pressure hoses” have a textile braided construction. They’re commonly used to transmit petroleum-based fluids, diesel fuel, hot lubricating oil, air, ethylene glycol anti-freeze, and water.

“Medium-pressure hoses” typically feature one- and two-wire braided construction. These hoses are frequently found on construction equipment, heavy-duty trucks, and fleet vehicle applications. In general, braided hose is selected for its flexibility.

At one time in the industry, two-wire braided hose was most commonly used in many applications. But the advent of larger, off-road specialty equipment drove the creation of spiral hose, which is very well suited for applications where extremely high impulse pressure is encountered.

Today, hydrostatic drives using four and six-wire spiral hoses can be found on everything from lawn tractors to earth movers. Because today’s world demands faster, more powerful equipment requiring increased working pressures, Parker is responding with an expansive offering of spiral products.



## Inner beauty

The inner tube of a hose is offered in several different rubber compounds. Each rubber compound can react differently to the media being conveyed. The inner tube must also resist effects of high or low temperatures and environmental elements. The table on the right highlights popular rubber compounds used for hose inner tubes:

Inner Tube Compounds	
Type	Features
PKR® Rubber	Excellent resistance to ozone and weathering; good heat resistance. Good resistance to petroleum-based fluids.
Synthetic Rubber	Excellent resistance to petroleum-based fluids and environmentally friendly fluids.
Butyl Rubber	Very good weathering resistance. Good physical properties. Poor resistance to petroleum-based fluids.
EPDM Rubber	Excellent resistance to phosphate ester fluids and dry air. Poor resistance to petroleum-based fluids.

## Strong like spiral bends like braided

Looking for flexible hose that can be routed in tight spaces?

Parker has a full line of hoses designed for one-half SAE bend radius at full SAE pressure. These hoses plumb and bend tighter than other SAE 100R1, 100R2,

100R4, 100R12 and 100R13 type hoses, reducing hose length requirements by up to 47%. The tighter bend radius means fewer bent tube fittings, and longer life in applications where machinery movement causes hoses to bend sharply. It also means reduced inventory requirements for you.

*GlobalCore Hose has half the bend radius of its SAE counterpart and a significantly smaller bend radius than corresponding-size Parker conventional spiral hose.*

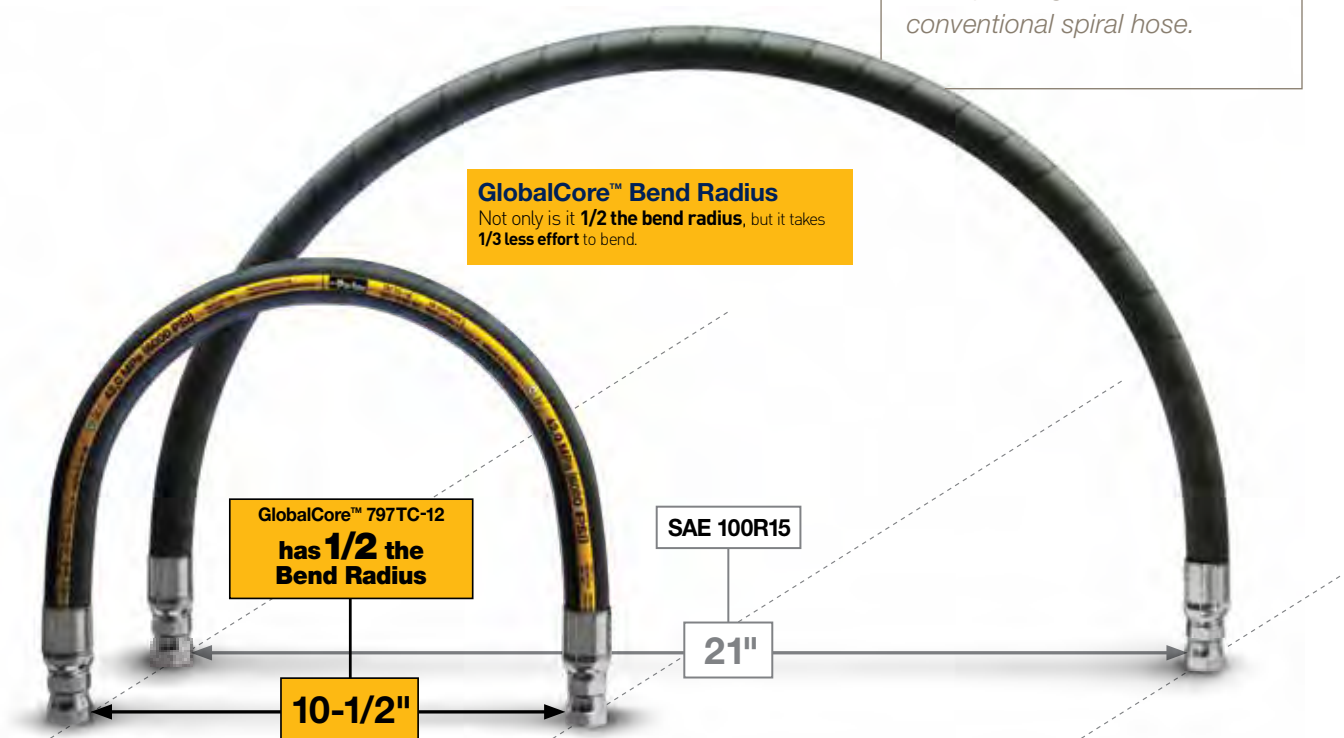



## Our layline is easier to read

Our new layline presents the most important information in an easier to read format. And the performance icons make it easier to identify what elements pertain to that hose.

**PERFORMANCE LEGEND**

Half SAE Bend	Tough Cover	SuperTough Cover	High Temperature	Low Temperature

The layline, or printing along the length of a hose, contains a wealth of useful information about that product. Inside diameter, maximum working pressure, part number, industry standards that the hose meets, and even manufacturing date are among the information supplied.

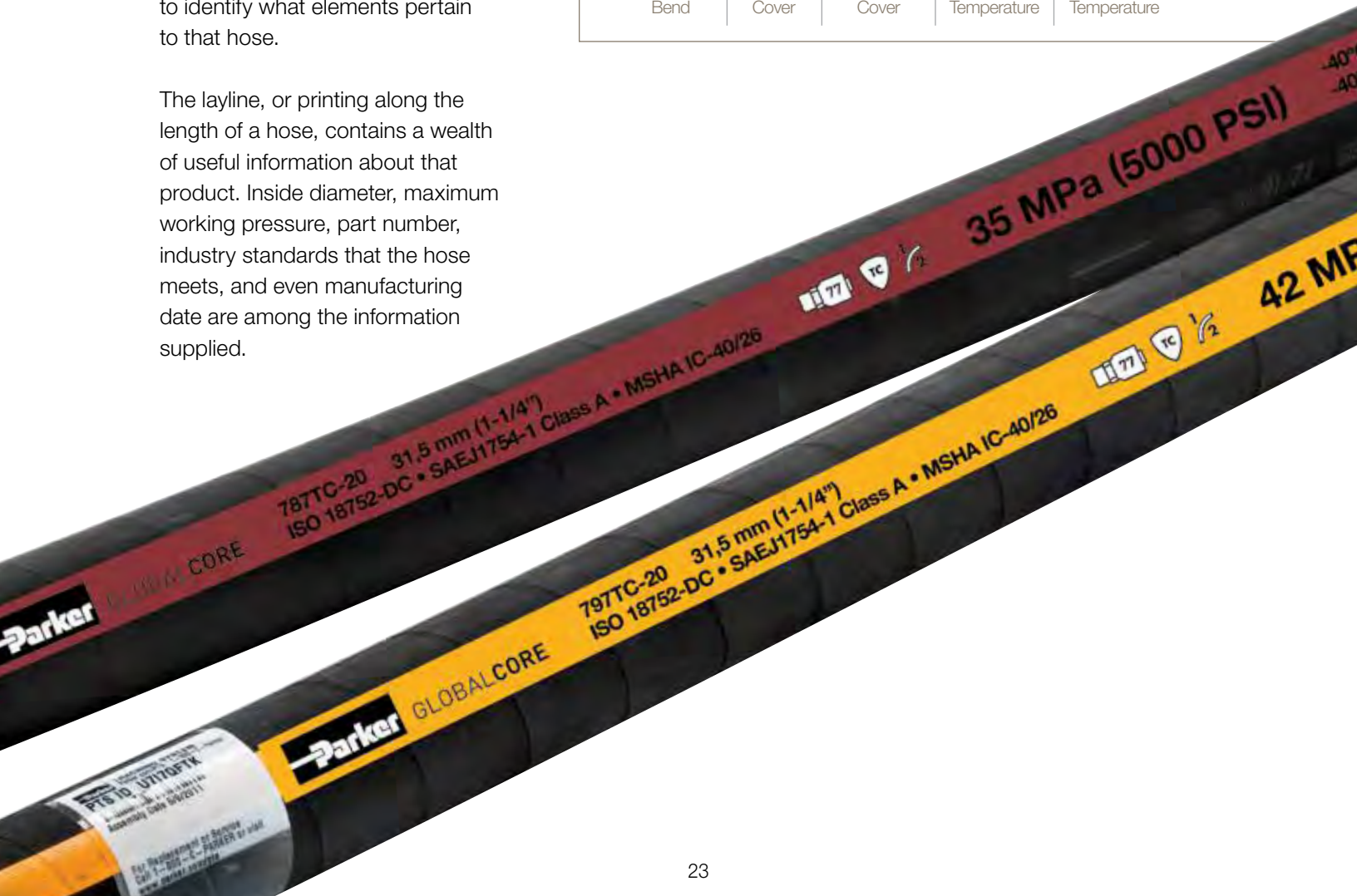

# Parker fittings

The products of choice for custom and standard applications



## Crimpable fittings

Parker Parkrimp assemblies consist of No-Skive hose and fittings, permanently joined by any one of our Parkrimp crimpers. The teeth in Parker's crimped fittings bite down to the hose wire for a metal-to-metal grip with maximum integrity. Our one-piece fittings can be combined with many No-Skive hose types to cover low-, medium- and high-pressure applications, as well as special application categories that can also be used with permanent crimped fittings.

We offer steel, brass, and stainless steel fittings from 3/16" to 3", with our steel fittings featuring a corrosion-resistant plating that exceeds SAE standards. Styles include o-ring face seal, flare, male pipe, metric designs and many more. All are compatible with the easy-to-use Parkrimp system of crimping machines.

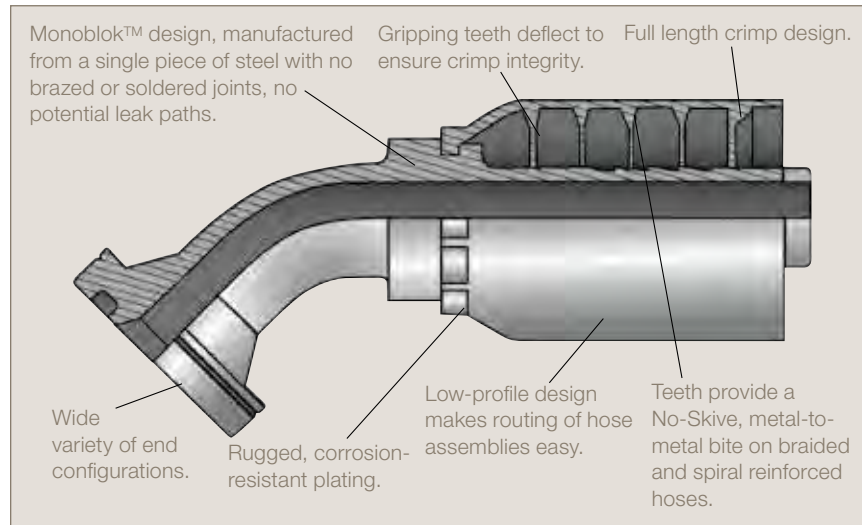

When combined with our No-Skive hose, Parker Parkrimp fittings provide factory-quality hose assemblies quickly and cost effectively.

## Monoblok™ fittings

Monoblok™ fittings are manufactured from a single piece of steel. First introduced in ultra-high-pressure hydraulic applications, their lack of brazed or

soldered joints provides the utmost in leak protection, eliminating any potential leak paths. Parker Monoblok fittings are available in a wide variety of end configurations and fitting series. These fittings also feature: No-Skive, bite-the-wire, full-length crimp, corrosion-resistant plating, weather seal, and a low-profile design.





## Metric fittings

Parker's metric fittings are available in a full range of DIN, BSP, BSPP, French GAZ, and JIS configurations to meet worldwide applications. Parker's metric fittings are available in a wide range of sizes to meet your requirements.

## Field attachable fittings

Parker field attachable fittings enable you to make hose assemblies right at the job site without special tools or machines.

Our wide range of No-Skive hose – hose that does not require the removal of the outer cover or inner tube prior to assembly – combines with a variety of field attachable steel, stainless steel, and brass fittings quickly and easily.

Parker field attachable fittings include the popular Push-Lok® style, as well as two- and three-piece series fittings that use an interchangeable nipple with one- and two-wire braided hose.

## Custom fittings for short-run or special applications

Custom tube and hose fittings are available from Parker. Configurations include NPTF, JIC, SAE, GAZ, ISO, DIN, JIS,

and BSP in a wide range of sizes. Material options include steel, stainless steel and brass. All of our products are manufactured to world-class standards.

### Hose Hint

*How tight is tight enough? Differences in platings and other variables can affect the amount of torque required to ensure a proper connection. Always refer to this catalog or go to [www.parkerhose.com](http://www.parkerhose.com) for proper assembly procedures.*

Hose End Type	Pressure	Seal Reliability	Vibration Resistance	Ease of Installation	Reusability	Temperature
Seal-Lok – O-Ring Face Seal	Excellent	Excellent	Very Good	Excellent	Excellent	Limited by Seal
37° Flare	Very Good	Good	Good	Good	Good	Excellent
Tapered – (NPT, NPTF, BSPT and Metric Taper)	Good*	Poor	Poor	Good	Poor	Excellent
Four-Bolt Flange	Excellent	Good	Excellent	Very Good	Excellent	Limited by Seal

*\*Rated 'Poor' for dynamic pressure systems.*

### Hose Hint

*Never mix and match one manufacturer's fittings with hose from another manufacturer. Parker hose, fittings, and crimpers are designed to work together as a system. This ensures optimum product performance, reliability, and safety.*



## Fittings with XTR coating for extreme resistance to corrosion

Parker XTR coating provides more than seven times SAE standard protection. An outstanding advantage for equipment in highly caustic applications and environments, Parker's proprietary formulation has been tested to resist corroding for more than

720 hours. Parker products with XTR coating assure all the leak-free performance and installation advantages that our customers expect. Even the assembly torque remains the same. For unmatched quality, service and support, now with extreme corrosion resistance, specify Parker hose and tube fitting products with XTR coating. For additional information, refer to Bulletin 4480-B158.

# Parkrimp crimpers

## Easy to use for safe and reliable high performance hose assemblies



With Parkrimp, you benefit from a full-length crimp. Our low-profile design makes routing hose assemblies easy. No-Skive hoses and fittings combine with the Parkrimp system to create high-quality, reliable hydraulic hose assemblies every time.

**The complete system from one source:** No-Skive hose, No-Skive fittings, and crimping machines with worldwide availability and service.

### Parker's Parkrimp system provides users with several key advantages:

- **Perfect alignment:** Parker's exclusive Parkalign™ system features a positive-stop design that positions the fitting in the die for a perfect crimp every time. Parkalign benefits operators by enabling them to "feel" that the hose is in the right position to be crimped, as compared to "eyeballing" the proper position of the fitting in a variable crimper.
- **Efficient design:** Bottomloading Parkrimp crimpers make it much easier for operators to manage long hose assemblies.
- **Linked dies:** Parkrimp dies are linked together to prevent segments from being misplaced or worse, mismatched.

- **Color-coded dies:** Parkrimp dies are color coded by size, making for easy identification and reduced set-up time.
- **Durability:** Since they were introduced in 1980, Parkrimp crimpers have been designed and manufactured to provide years of reliable service.
- **Decals:** Parkrimp crimpers come with an information-rich decal that provides the list of proper hose and fitting combinations, tools required and the crimp specification for each hose and fitting combination.
- **Crimpsource:** the most complete online resource for Parker crimp specifications, technical manuals, decals and more.

Parker Hose Product Division also offers a full line of crimping accessories, including conversion kits, cabinets, cut-off saws, push-on tables, die racks, and mandrel tool kits. See the Equipment section for full details.

### Modular design with all the familiar Parkrimp system advantages

Parker offers two Parkrimp-style modular crimpers – the Karrykrimp and the Karrykrimp 2. Their modular design enables the customer to choose between the portability that Parker Karrykrimp crimpers have always offered and the new option to make these same crimpers bench-mounted units.

The modular design gives users the flexibility of a portable crimper with the advantage of increased productivity when connected to the stationary power unit.

### Modular Crimper – Portable or Bench-Mounted



Karrykrimp



Karrykrimp Bench Mount



Karrykrimp 2



Karrykrimp 2 Bench Mount

Eight-segment crimp dies provide a smooth, even, 360-degree crimp.

Our linked crimp dies keep die segments together. No loose parts to mismatch or misplace.

Dies are color coded by size for easy identification and reduced set-up time.

Bottom-loading operation makes it easy to handle long hose assemblies.

Parker's exclusive Parkalign™ feature positions the fitting in the dies perfectly every time.

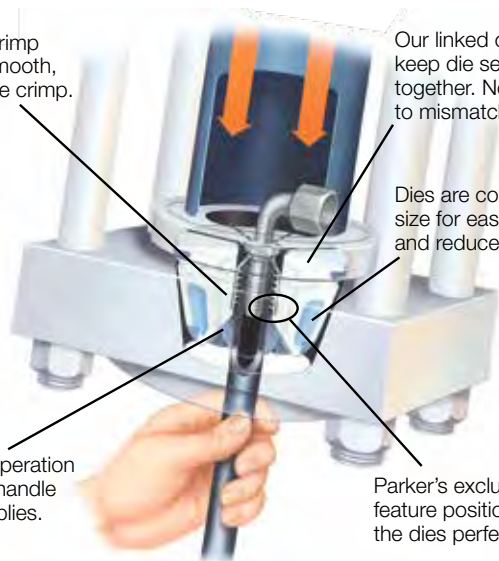

Parkrimp dies are color coded and linked together – making them easy to use.

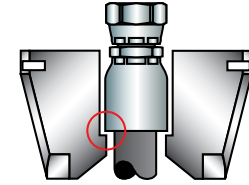

The Parkalign system's positive stop feature ensures users will make a perfect crimp every time.

Downloadable decals are just one of the many assets found on Crimpsource.

**The modular crimper features:**

- A single crimping unit can be either portable or bench-mounted
- Faster cycle times on bench-mounted units
- Increased height enables longer bent tube fittings to be crimped
- Cylinder maintenance on the Karrykrimp 2 is now possible

Parker's Parkrimp® System continues to lead the industry in ease of use, accuracy and effectiveness. The Parkrimp system is designed to crimp fittings to the proper diameter every time, meaning fluid power professionals will not waste valuable time dialing variable settings that can produce mis-crimps. Designed to produce accurate crimps from the first time it's used, Parkrimp system crimpers require no calibration and continuously produce proper crimps, time after time.

Parker		Parker Hannifin Corporation Hose Products Division 30240 Lakeland Blvd. Wickliffe, Ohio 44092		Parkrimp 2 Hose Die Selection Chart									
Series	HOSE	-4 RED	-5 PUR	-6 YEL	-8 BLU	-10 ORG	-12 GRN	-16 BLK	-20 WHT	-24 RED	-32 GRN		
Series	Die Part Number	80C-A04	80C-A05	80C-A06	80C-A08	80C-A10	80C-A12	80C-A16	80C-A20	80C-A24	80C-A32		
43	351S17/C 426	451S17/C 431	4721/C 424	0.645	0.710	0.825	0.945	1.060	1.245	1.590	2.290		
	387S2P17/C (-4 THRU -16) 432	472L 436	487M17S17/C (-4 THRU -12) 439	0.665	0.730	0.845	0.965	1.080	1.265	1.610	2.310		
43	421W/C 302	341	601 604	0.685	0.750	0.865	0.985	1.100	1.285	1.630	2.330		
	387S2P17/C (-20 ONLY) 301L	381	487M17S17/C (-16 ONLY) 381	0.705	0.770	0.885	1.005	1.120	1.305	1.650	2.350		
	722722S17/CAT (-6 THRU -20 ONLY)										2.775		
	83C-D06	83C-D08	83C-D10	1.440	1.260								

**Parker Crimpsource™**

Crimpsource is the industry's most complete resource for crimper technical information. It contains all of the crimp specifications approved for Parker's rubber, industrial and thermoplastic hose:

- Crimp specs
- PDFs of technical manuals for easy downloading
- Parts lists
- Troubleshooting advice
- PDFs of crimper decals for immediate printing
- Custom decals available

Crimpsource provides easy access to all the specifications necessary to correctly fabricate a factory quality hose assembly.



A series of drop-down menus enables users to find what they need quickly and easily. Choose your crimper and then select the hose, fittings and current specifications needed to make hose assemblies.

You can also print a simple-to-follow data specification sheet or crimper decal. Crimpsource is available at [www.parker.com/crimpsource](http://www.parker.com/crimpsource).

# Rapid service unit

Our Rapid Service Unit (RSU) has the experience and the knowhow to design custom and prototype hose fittings to exact specifications, whether from drawings, models, or verbal specifications. The unit is responsible for both checking the technical requirements of the customer request from an engineering perspective as well as establishing the most economic production process. Using standard Parker end designs, we can create highly specific assemblies in both metric and inch connections to precisely match your specifications. With the latest in manufacturing technology, we can begin production right away with the type of raw material you need for your application. When timing is vital, RSU is your single source for critical pieces, custom prototypes, or uncommon sized parts in one-piece or short-run

productions. With five shifts, as well as computer numeric-controlled (CNC) lathes and machining centers working 24 hours daily, seven days a week, we can design and build products in the time it would take most manufacturers to simply devise a plan. In as few as 24 hours for some orders, we get you what you need when you need it to keep production moving. Whether it's shipped to your nearest Parker Store, your plant, or directly to the worksite. We specialize in making custom and non-standard parts in uncommon sizes, including:

- Custom bent and straight fittings
- Custom prototypes
- Unusual hose and tube combinations
- Jump sizes
- Tube assemblies
- Steel, stainless steel, and brass

## Features:

- No minimum order
- Custom prototypes
- Steel, stainless steel, and brass
- Custom configurations
- Premier product support
- Meets DFAR compliance
- Tamper-resistant labeling
- Pressure testing
- UL, LPC, and USCG Certifications, where applicable



# Custom hose tube assemblies

Hose Products Division prides itself on delivering exceptional quality and reliability when it comes to hose and tube components. Markets are shifting to replacing sections of hose with hard plumbing. These custom projects can include tube fabrication

and fittings not found anywhere else. Using custom tube and hose assemblies can reduce your overall costs and eliminate warranty issues. Completely custom products are available from a dedicated Parker Hose Products Division facility. Using

standard Parker hoses, fittings and tubing, our experts create custom tube and hose assemblies that exactly match your specifications to provide increased durability and reliability.

Parker experts can create custom tube and compound assemblies that exactly match your specifications.



# Technical support, education and training



Our technicians and market specific engineers can be found around the country and throughout the world to offer you engineering support, fluid connector system design, and product selection assistance. Phone consultation, as well as on- or off-site sessions are available virtually anywhere for all customers, distributors, and employees. Topics range from hose routing tips and troubleshooting to critical safety procedures. Our Parker experts reflect our extensive commitment to training and education, and are an important part of our value-added service.



## **Parker Training and Certification (P-TAC)**

P-TAC encompasses online (e-learning) and off-line (instructor-led classroom) training in addition to certification recognition.

**[Parker.com/PTAC](http://Parker.com/PTAC)**

In addition to the Parker Training and Certification development program, more information can be found online. For additional online resources, please visit the following:

- Blogs: **[www.parker.com/HPD\\_Blogs](http://www.parker.com/HPD_Blogs)**
- Product Videos: **[www.parker.com/HPD\\_videos](http://www.parker.com/HPD_videos)**
- CAD: **[www.parker.com/HPD\\_CAD](http://www.parker.com/HPD_CAD)**

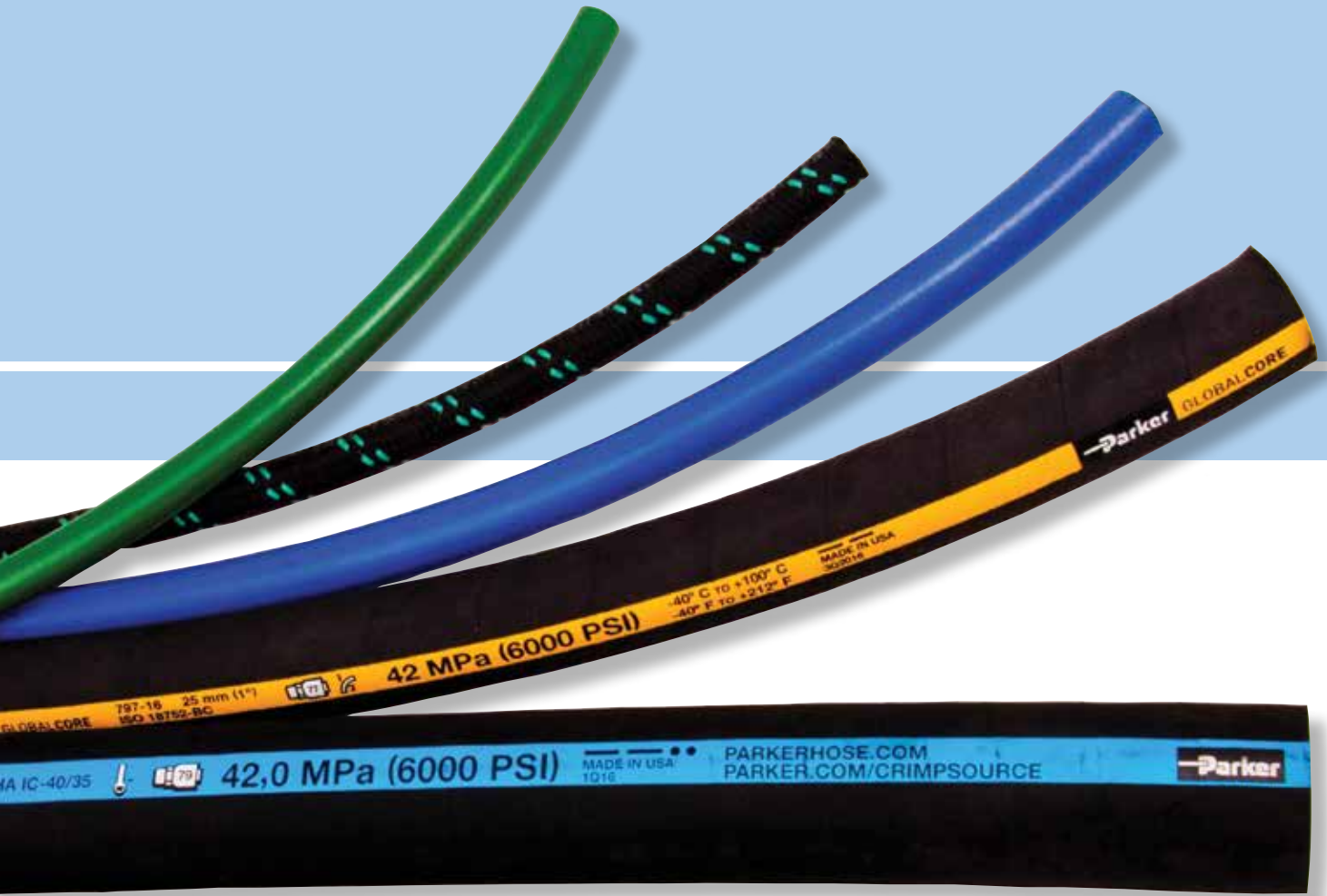

# Hose

GlobalCore Hydraulic Industry Standard Suction & Return Line  
Push-Lok Multipurpose Phosphate Ester Low Temperature  
Transportation Alternative/Marine Refrigerant

# Hose visual index

	<p>187 A-13</p>  <p>ISO 18752</p>	<p>387 A-14</p>  <p>ISO 18752</p>	<p>487 A-15</p>  <p>ISO 18752</p>
<p>722 A-16</p>  <p>ISO 18752</p>	<p>787 A-17</p>  <p>ISO 18752</p>	<p>797 A-18</p>  <p>ISO 18752</p>	
<p>JK A-19</p>  <p>ISO 1436-1 TYPE 2 SN</p>	<p>422 A-20</p>  <p>ISO 1436-1 TYPE 1SN</p>	<p>482TC A-21</p>  <p>ISO 1436-1 TYPE 1SN</p>	<p>482ST A-21</p>  <p>ISO 1436-1 TYPE 1SN</p>
<p>426 A-22</p>  <p>SAE J517 100R1AT</p>	<p>302 A-23</p>  <p>ISO 1436-1 TYPE 2SN</p>	<p>436 A-24</p>  <p>ISO 11237 TYPE R16</p>	<p>471TC A-25</p>  <p>ISO 11237 TYPE 2SC</p>
<p>471ST A-25</p>  <p>ISO 11237 TYPE 2SC</p>	<p>471TC Twin Tough A-26</p>  <p>ISO 11237 TYPE 2SC</p>	<p>472TC A-27</p>  <p>SAE J1942</p>	<p>722TC A-28</p>  <p>ISO 3862-1 TYPE R12</p>
<p>722ST A-28</p>  <p>ISO 3862-1 TYPE R12</p>	<p>777 A-29</p>  <p>4,000 psi ISO 18752</p>		<p>811 A-30</p>  <p>SAE J517 100R4</p>
<p>811HT A-31</p>  <p>SAE J517 100R4</p>	<p>881 A-31</p>  <p>SAE J517 100R4</p>		<p>801 A-32</p> 
<p>836 A-34</p> 	<p>804 A-34</p> 	<p>821 A-35</p> 	<p>821FR A-35</p> 
<p>627 A-36</p> 		<p>424 A-37</p> 	<p>304 A-38</p> 
<p>774 A-38</p> 	<p>F42 A-39</p> 		<p>472LT A-40</p>  <p>EN 857 TYPE 2SC</p>

A

B

C

D

E



## Hose visual index

<p>722LT A-41</p>  <p>ISO 3862-1 TYPE R12</p>	<p>792LT A-41</p>  <p>SAE J517 100R15</p>	<p><b>Transportation Hose</b></p>	<p>293 A-42</p>  <p>SAE J1402 AI</p>
<p>213 A-43</p>  <p>SAE J1402 AI</p>	<p>266 A-44</p>  <p>SAE J1402 AII</p>	<p>201 A-45</p>  <p>SAE J517 100R5</p>	<p>206 A-46</p>  <p>SAE J517 100R5</p>
<p>611HT A-47</p>  <p>SAE J517 100R6</p>	<p>271 A-48</p>  <p>SAE J1402 A</p>	<p><b>Alternative/ Marine Hose</b></p>	<p>SS23CG A-49</p>  <p>UL 21</p>
<p>SS25UL A-50</p>  <p>UL 21 / NFPA 58</p>	<p>SS25UL-AGA A-50</p>  <p>AS / NZS 1869-2012 CLASS D</p>	<p>221FR A-51</p>  <p>ISO 7840</p>	<p><b>Refrigerant Hose</b></p>
<p>285 A-52</p>  <p>SAE J2064-C</p>	<p>244 A-53</p>  <p>SAE J2064-B CLASS 1</p>		

A

B

C

D

E

# How to read the hose section

Parker offers a wide variety of hoses including braided, spiral, multi-purpose, transportation, refrigerant, LP gas and more. Parker's product line has been tested and approved to meet

and exceed global standards. Our hoses range in size from 3/16" to 3" I.D. and are compatible with crimp and field-attachable style fittings. Specific hose information is displayed throughout the catalog and

is defined by the information shown below. Please take a moment and review.

Catalog 4400 US GlobalCore: 3000 PSI Hydraulic Hose: 387

**HYDRAULIC 387**

**Markets**

**Performance**

1/2 TC ST

21 MPa (3000 PSI)

Parker's GlobalCore 387 hose provides 3,000 psi (21 MPa) constant working pressure in all sizes. Available in a variety of cover options so you can match the right cover to your application, 387 hose offers you the choice of Standard, ToughCover and SuperTough Cover. Designed, built and tested to the ISO 18752 performance specifications. Parker's 387 hose is unmatched in today's marketplace.

- 1/2 ISO 18752 minimum bend radius
- Low force to flex for ease of installation
- 3,000 psi constant working pressure in all sizes
- Exceeds ISO 18752 performance specification (AC, BC and CC)
- Synthetic rubber inner tube provides a wider range of fluid compatibility
- TC cover provides 80 times and ST cover 450 times abrasion resistance when compared to standard covers

**Markets**

Transportation	RV & Bus	Military	Construction	Agriculture	Grounds & Building Maintenance	Forestry
Railroad	Utility Equipment	Personnel Lift Equipment	Machine Tool	Oil Field Service	Waste & Refuse	Material Handling
Marine	Paving & Road Maintenance	Ground Support Equipment	Industrial	Mining	Automotive	Aftermarket

**Performance Legend**

Half SAE Bend	ToughCover	SuperTough Cover	High Temperature	Low Temperature
---------------	------------	------------------	------------------	-----------------

### Catalog Sections

- Hose Section
- Accessories Section
- Fittings Section
- Technical Section
- Equipment Section

### Parker Hose Nomenclature

Example: 387TC-8  
**387**TC-8 - Hose Type  
 387**TC**-8 - Indicates the special feature of the hose (in this case, 'Tough Cover')  
 387TC-**8** - Hose inside diameter dash size (in this case, 8/16" or 1/2")

A

B

C

D

E

#### Hose Information

- Base part number
- Description
- SAE, ISO, and EN specifications

#### Hose Inner Diameter

Measured in 1/16 inch increments identified by use of a "dash"(-) numbering system. i.e., 4/16" = 1/4" = -4.

#### Hose Outer Diameter

A critical measurement when considering hose clamps and applications where envelope size is limited.

#### Hose Working Pressure

Should have a working pressure rating meeting or exceeding the maximum operating pressure of the system. The maximum rating is listed below for where the hose is to be used.

Visually shows **hose construction**.

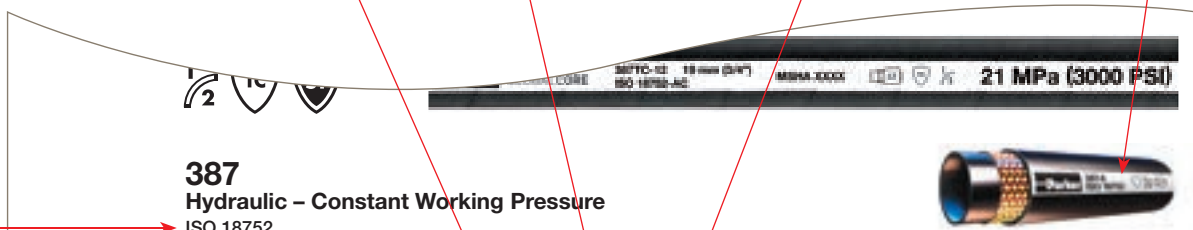

### 387 Hydraulic - Constant Working Pressure ISO 18752

# Part Number	Standard Cover	Tough Cover	Super Tough	Hose I.D.		Hose O.D.		Working Pressure		Minimum Bend Radius		Weight		Vacuum Rating		Parkrimp 43 Series	Parkrimp 77 Series
	387	387TC	387ST	inch	mm	inch	mm	psi	MPa	inch	mm	lbs/ft	kg/m	inches of Hg	kPa		
387	ISO 18752 Performance																
387-4	AC	AC	AC	1/4	6,3	0.53	13,4	3000	21,0	2	50	0.16	0,24	24	80		
387-6	AC	AC	AC	3/8	10	0.69	17,4	3000	21,0	2-1/2	65	0.23	0,34	24	80		
387-8	AC	AC	AC	1/2	12,5	0.82	20,7	3000	21,0	3-1/2	90	0.29	0,43	24	80		
387-10	AC	AC	AC	5/8	16	0.94	23,9	3000	21,0	4	100	0.33	0,49	24	80		
387-12	AC	AC	AC	3/4	19	1.10	27,8	3000	21,0	4-3/4	120	0.58	0,86	24	80		
387-16	AC	AC	AC	1	25	1.40	35,4	3000	21,0	6	150	0.79	1,17	24	80		
387-20	BC	CC	CC	1-1/4	31,5	1.82	46,3	3000	21,0	8-1/4	210	1.74	2,59	18	60		
387-24	BC	CC	CC	1-1/2	38	2.08	52,8	3000	21,0	10	250	2.01	2,99	18	60		
387-32	BC	CC	CC	2	51	2.61	66,2	3000	21,0	12-1/2	320	2.75	4,09	18	60		

**Application:** Petroleum base hydraulic fluids and lubricating oils.

**Inner Tube:** Synthetic rubber.

**Reinforcement:** One-braid steel wire for sizes -4 to -8  
 Two-braid steel wire for sizes -10 to -16  
 Four-spiral steel wire for sizes -20 to -32

**Cover:** Standard Cover: Synthetic rubber  
 ToughCover: Synthetic rubber abrasion resistant  
 SuperTough Cover: Synthetic rubber super abrasion resistant

**Fittings:** 43 Series, sizes -4 to -20 - pg. B-27.  
 77 Series, sizes -20 to -32 - pg. B-92.

**Temperature Range:** Standard Cover: -40°F to +212°F (-40°C to +100°C)  
 ToughCover & SuperTough Cover: -40°F to +257°F (-40°C to +125°C)

A-13

For more information regarding hose application and temperature, see the Technical Section.

#### Minimum Bend Radius

Is the smallest arc that the hose can be bent before its life is greatly reduced. Exceeding the bend radius can cause kinking, inner tube washout and excessive stress on reinforcement.

#### Weight

Provided by the foot for instances where it is a critical parameter in the design of the system.

#### Approved Fitting

To be used with the hose. Could be crimped or field attachable.

# Hose overview chart

Hose Size	Hose Reinforcement	-4	-5	-6	-8	-10	-12	-16	-20	-24	-32	-40	-48	Standard Temp. Range °F	SAE	ISO	EN	Page
187					1000	1000	1000	1000	1000	1000	1000	1000		-40/+212/ +257		18752		A-13
387		3000		3000	3000	3000	3000	3000	3000	3000	3000			-40/+212/ +257		18752		A-14
487		4000		4000	4000	4000	4000	4000	4000	4000	4000			-40/+212/ +257		18752		A-15
722				4000	4000	4000	4000	4000						-40/+212/ +257		18752		A-16
787		5000		5000	5000	5000	5000	5000	5000	5000	5000			-40/+212/ +257		18752		A-17
797		6000		6000	6000	6000	6000	6000	6000	6000	6000			-40/+212/ +257		18752		A-18
JK		10500		10000										-40/+120	J517 100R2AT	1436-1-2SN	853-2SN	A-19
422		3250	3125	2600	2325	1875	1525	1275	900	725	575			-40/+212	J517 100R1AT/ J1942	1436-1-1SN	853-1SN	A-20
482TC/ST		3250	3250	3000	2500	2000	1750	1275						-40/+212	J517 100R1AT/ J1942	1436-1-1SN	853-1SN	A-21
426		2750		2250	2000	1500	1250	1000	625	500	375			-50/+302	J517 100R1AT/ J1942			A-22
302		5800	5000	4750	4000	3600	3100	2400	1800	1300	1150			-40/+212	J517 100R2AT/ J1942	1436-1-2SN	853-2SN	A-23
436				4000	3500	2750	2250	2000						-55/+302	J517 100R16	11237-R16		A-24
471TC/ST		5800		5000	4250	3625	3125	2500						-40/+212	J1942	11237-2SC	857-2SC	A-25
471TC Twin Tough				5000	4250									-40/+212	J1942	11237-2SC	857-2SC	A-26
472TC									2250	1800	1300			-40/+212	J1942			A-27
722TC/ST									3000	2500	2500			-40/+257	J517 100R12/ J1942	3862-1-R12	856-R12	A-28
777							4000	4000						-40/+212/ +257		18752		A-29
811/811HT with HC							100	70	50	50	50	62		-40/+212/ +257	J517 100R4/ J1942*			A-30
811/811HT with 81							300	250	200	150	100	62		-40/+212/ +257	J517 100R4/ J1942*			A-31
881 with HC							100	70	50	50	50	62		-40/+257	J517 100R4/ J1942			A-31
881 with 43/81/DB							300	250	200	150	100	62		-40/+257	J517 100R4/ J1942			A-31

A

B

C

D

E

# Hose overview chart

Hose Size	Hose Reinforcement	-4	-5	-6	-8	-10	-12	-16	-20	-24	-32	-40	-48	Standard Temp. Range °F	SAE	ISO	EN	Page	
Push-Lok	801		350		350	300	300	300	200						-40/+257				A-32
	836		400		400	400	350	300							-55/+302				A-34
	804		150		150	150	150	150							-40/+176				A-34
	821		350		300	300	250	250							-40/+212				A-35
	821FR		350		300	300		250							-40/+212				A-35
Phosphate Ester	627														-40/+212				A-36
	304		5000		4000	3500	2750	2250	2000	1625	1250	1125			-40/+176				A-38
	774							4000	4000	3000	2500	2500			-40/+176				A-38
	424								1000	625	500	375			-40/+176				A-37
	F42					6000		6000	6000	6000					-40/+176				A-39
Low-Temp	472LT		5800		5000	4250	3625	3125	2500						-70/+212			857-2SC	A-40
	722LT				4000	4000	4000	4000	4000	3000	2500				-70/+212	J517 100R12	3862-1-R12	856-R12	A-41
	792LT								6000	6000	6000				-70/+212	J517 100R15	3862-1R15	856-R15	A-41
Transportation	293		500		500	500	450	450	450						-58/+302	J1402 AI			A-42
	213		2000	1500	1500	1250	1000	750	400	300	300	200	175		-50/+302	J1402 AI			A-43
	266		2000	1500	1500	1250	1250	750	400	300	250				-55/+302	J1402 AII			A-44
	201		3000	3000	2250	2000	1750	1500	800	625	500	350	350	200	-40/+302	J517 100R5/ J1402 AII			A-45
	206		3000	3000	2250	2000	1750	1500	800	625	500	350	350		-55/+302	J517 100R5/ J1402 AII			A-46
	611HT		400		400	400	350	300							-55/+302	J517 100R6		854-R6	A-47
	271				225	225									-50/+212	J1402 A			A-48
Alternative/Marine	SS23CG				425	425	425	425							-40/+250				A-49
	SS25UL		350	350	350	350	350	350							-40/+250				A-50
	SS25UL-AGA		350	350	350	350	350	350							-40/+250				A-50
	221FR			500	500	500	500	500	500						-4/+212	J1527 A Class I/ J1942	7840		A-51
Refrigerant	285		500		500	500	500	500							-22/+257	J2064-C			A-52
	244								500	500	350				-22/+257	J2064-B Class 1			A-53

A

B

C

D

E

\*811 Hose is not compliant with SAE J1942

# How to order crimped hose assemblies

Box 1	Box 2	Box 3	Box 4	Box 5	Box 6	Box 7	Box 8	Box 9	Box 10	Box 11
F	387	06	39	08	08	08		-24		

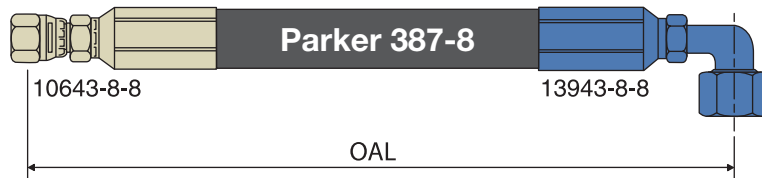

A

B

Box 1: Prefix	
Symbol	Description
F =	Parkrimp Crimp Fittings (43, 77 Series, etc.)
P =	Parkrimp Crimp Fittings (26 Series only)
Y =	Permanent Crimp Fittings (HY Series only)
K =	Permanent Crimp Fittings (81 Series only)

Box 7: Hose Size	
Symbol	Description
08 =	1/2 inch Hose Inner Diameter

C

Box 2: Hose Type	
Symbol	Description
387 =	ISO 18752 Hose

**Note:** see page A-6 for complete list of Parker Hoses

Box 8: Fitting Material	
Symbol	Description
No Suffix =	Steel
B =	Brass
C =	316 Stainless Steel
BA =	Brass nipple with steel nut and socket
BS =	Brass nipple with brass nut and steel socket
ZJ =	XTR plating

D

Box 3: 1st Fitting End Configuration	
Symbol	Description
06 =	Female JIC 37 Degree Swivel Straight

**Note:** See page E-32 for a complete list of fitting configurations

Box 9: Over All Length (OAL)	
Symbol	Description
24 =	Expressed in inches (610 mm)

OAL of a hose assembly is measured from the end of the straight fitting or centerline of the fitting seat. OAL of the Seal-Lok® hose assembly is measured to the sealing surface of the straight fittings or to the centerline of the elbow fittings

E

Box 4: 2nd Fitting End Configuration	
Symbol	Description
39 =	Female JIC 37 Degree Swivel 90 Degree Elbow - Short Drop

Box 10: Displacement Angle	
Symbol	Description
270	Specified only if two (2) elbow fittings are used. Starting with either end as the far end, measure angle clockwise to describe the displacement angle of the near end

Box 5: 1st Fitting End Connection Size	
Symbol	Description
08 =	1/2" Female JIC (3/4x16 Thread)

Box 11: Hose Assembly Guards	
Symbol	Description
SG =	Spring Guard
HG =	Polyguard
PG =	ParKoil™
FS =	Fire Sleeve
AS =	Partek Sleeving
PS =	Partek Sleeving

**Note:** When spelling out an assembly part number, list entire sleeving part number

Box 6: 2nd Fitting End Connection Size	
Symbol	Description
08 =	1/2" Female JIC (3/4x16 Thread)

# How to order field attachable hose assemblies

Box 1	Box 2	Box 3	Box 4	Box 5	Box 6	Box 7	Box 8	Box 9	Box 10	Box 11
R	201	06	39	06	06	08		-24		

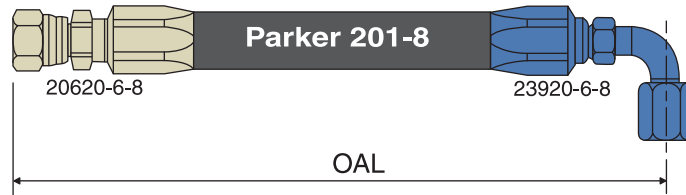

Box 1: Prefix	
Symbol	Description
R =	Field Attachable (all series except 22 & 23)
M =	Field Attachable (22 & 23 Series only)
B =	Clamp i.e., 88HC-H and 88DB on 88 Series
C =	Worm Gear Clamp i.e., 88H Series on 88 Series

Box 2: Hose Type	
Symbol	Description
201 =	SAE 100R5
<b>Note:</b> See page A-6 for complete list of Parker Hoses	

Box 3: 1st Fitting End Configuration	
Symbol	Description
06 =	Female JIC 37 Degree Swivel - Str.
<b>Note:</b> See page E-32 for a complete list of fitting configurations	

Box 4: 2nd Fitting End Configuration	
Symbol	Description
39 =	JIC 37 Degree Flare Elbow

Box 5: 1st Fitting End Connection Size	
Symbol	Description
06 =	3/8" JIC (9/16x18 Thread)

Box 6: 2nd Fitting End Connection Size	
Symbol	Description
06 =	3/8" JIC (9/16x18 Thread)

Box 7: Hose Size	
Symbol	Description
08 =	13/32 inch Hose Inner Diameter

Box 8: Fitting Material	
Symbol	Description
No Suffix =	Steel
B =	Brass
C =	316 Stainless Steel
BA =	Brass nipple with steel nut and socket
BS =	Brass nipple with brass nut and steel socket

Box 9: Over All Length (OAL)	
Symbol	Description
24 =	Expressed in inches (610 mm)
OAL of a hose assembly is measured from the end of the straight fitting or centerline of the fitting seat. OAL of the Seal-Lok® hose assembly is measured to the sealing surface of the straight fittings or to the centerline of the elbow fittings	

Box 10: Displacement Angle	
Symbol	Description
270	Specified only if two (2) elbow fittings are used. Starting with either end as the far end, measure angle clockwise to describe the displacement angle of the near end

Box 11: Hose Assembly Guards	
Symbol	Description
SG =	Spring Guard
HG =	Polyguard
PG =	ParKoil™
FS =	Fire Sleeve
AS =	Partek Sleaving
PS =	Partek Sleaving
<b>Note:</b> When spelling out an assembly part number, list entire sleaving part number	

A

B

C

D

E

# GLOBAL CORE™

Providing a simple solution of robust hydraulic hoses designed to endure the tough conditions where work gets done, GlobalCore is the future that OEMs and end users around the world have been asking for.

You know Parker as the global leader in providing unprecedented performance and value for hydraulic systems with high-pressure applications. With our GlobalCore solution, you can significantly reduce your inventory and part number complexity by using GlobalCore's constant working pressure hoses and fittings.

Designed to meet the most common working pressures in industry, GlobalCore stands above the competition and serves customers around the world with a simple family of constant working pressure hoses.

GlobalCore hoses are manufactured in the major regions of the world – North America, Europe and Asia – supporting the equipment they serve, regardless of where it was originally manufactured, or where it is today.

Designed, built and tested to the ISO 18752 specifications, GlobalCore reduces engineering and service complexity by providing the first comprehensive product family across the most commonly used constant working pressure classes.

Parker's worldwide reach makes GlobalCore easier to specify and source through our unrivaled industrial distribution network of 13,000 locations globally.

Hoses	-4	-6	-8	-10	-12	-16	-20	-24	-32	-40	-48
7 MPa / 1,000 psi			187	187	187	187	187	187	187	187	187
21 MPa / 3,000 psi	387	387	387	387	387	387	387	387	387		
28 MPa / 4,000 psi	487	487/722	487/722	487/722	487/722	487/722	487	487	487		
35 MPa / 5,000 psi	787	787	787	787	787	787	787	787	787		
42 MPa / 6,000 psi	797	797	797	797	797	797	797	797	797		

Fittings	-4	-6	-8	-10	-12	-16	-20	-24	-32	-40	-48
7 MPa / 1,000 psi			43	43	43	43	43	43	43	43	43
21 MPa / 3,000 psi	43	43	43	43	43	43	43,77	77	77		
28 MPa / 4,000 psi	43	43	43	43	43	43	77	77	77		
35 MPa / 5,000 psi	43	43	77	77	77	77	77	77	77		
42 MPa / 6,000 psi	43	43	77	77	77	77	77	77	77		

All hoses rated to ISO 18752 performance specifications  
Various cover options available, see hose charts for detail





# High performance

Because challenges can emerge anytime and anywhere, your solution should endure the tough conditions of your work environment. The high performance standards designed, engineered and manufactured into GlobalCore provide the longest service life possible.

With GlobalCore hoses tested to twice their ISO 18752 standard, high performance in rugged environments and high impulse applications is ensured.

Long known as the premier manufacturer of hydraulic hoses, you can expect Parker's GlobalCore system will continue to meet our own rigorous standards of excellence.

Additional value is realized through:

- 212° / 257° F temperature ratings
- Standard, ToughCover and SuperTough Cover technologies for abrasion resistance
- 1/2 minimum bend radius
- Low force to flex for ease of installation
- Advanced inner tube chemistry

# Cohesive

GlobalCore is a unified system that delivers hoses designed, built and tested to the ISO 18752 specification.

Released in 2006, and quickly adopted by customers worldwide, Parker is at the forefront of delivering this universal standard for hydraulic hoses.

The ISO 18752 specification was developed based on how hoses are specified and used by customers - by pressure range, and not by construction. It's a truer specification based on today's needs. Although the specification covers hoses ranging from 500 psi through 8,000 psi and in sizes from -3 to -64, our focus is on the critical range where our customers operate.

GlobalCore expands our range of ISO 18752 hoses and provides options for the most critical sizes and pressure ranges.

ISO 18752 Performance Definitions (4.2 Grades and Types)				
Grade	Type <sup>a</sup>	Resistance to Impulse		
		Temperature °C	Impulse Pressure (% of MWP <sup>b</sup> )	Minimum Number of Cycles
A	AS	100	133%	200,000
	AC			
B	BS	100	133%	500,000
	BC			
C	CS	120	133% and 120% <sup>c</sup>	500,000
	CC			
D	DC	120	133%	1,000,000

<sup>a</sup> Standard or compact, e.g. CS is grade C and standard type. Standard types have larger outside diameters and larger bend radii and compact types have smaller outside diameters and smaller bend radii.  
<sup>b</sup> Maximum working pressure.  
<sup>c</sup> 120% of the MWP shall be used for classes 350, 420 and 560 instead of 133%.  
 ISO 18752 classifies according to their resistance to impulse into four grades: A, B, C and D. Each grade is classified by outside diameter into standard types (AS, BS and CS) and compact types (AC, BC, CC and DC) as shown in this table.



A

B

C

D

E

# Global

A single cohesive family of complimentary products so qualified has never before been offered globally.

With manufacturing locations in the major global regions, regardless of where your equipment was originally manufactured or is today, GlobalCore will support your hydraulic hose needs.

## Simple

GlobalCore is a unified system that delivers hoses built on the ISO 18752 specifications, which was developed on how hoses are specified and used by customers – by pressure range and not by construction. Therefore, the selection process is simple. Select the GlobalCore hose based on maximum working pressure required for your application.

Selecting the fitting is even simpler. Choose the renowned 43 Series, with more than 2,500 configurations, or the 77 Series, designed specifically for higher pressure applications and available in more than 500 configurations.

## Agency approvals

GlobalCore carries the most common international agency approvals as requested by our customers. ABS, DNV, Lloyd's, MSHA\*, USCG are comprehensive approvals, while other certifications will be specific to designated hoses or sizes.



Visit [parkerglobalcore.com](http://parkerglobalcore.com) for the latest list of hose and agency approvals.\*

Visit [www.parker.com/GlobalCore](http://www.parker.com/GlobalCore) for more information.

\*MSHA only approved for TC and ST cover options.



# HYDRAULIC

# 187

## Markets



Parker's GlobalCore 187 Hose provides 1,000 psi (7 MPa) constant working pressure in sizes -8 through -48. Designed and engineered for reliable, lasting performance in high-pressure hydraulic applications, 187 Hose is unmatched in today's marketplace.

- ½ ISO 18752 minimum bend radius (up to -32)
- Low force to flex for ease of installation
- Exceeds ISO 18752 performance specification (AC and AS)
- Synthetic rubber inner tube provides a wider range of fluid compatibility
- TC cover provides 80 times and ST cover 450 times abrasion resistance when compared to standard covers

## Performance

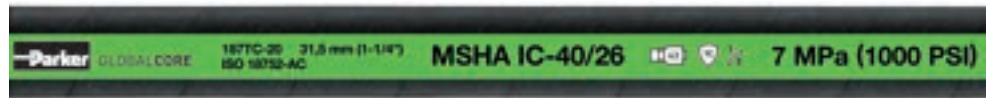

view on web page

## 187 Hydraulic – Constant Working Pressure ISO 18752

# Part Number	Cover			Hose I.D.		Hose O.D.		Working Pressure		Minimum Bend Radius		Weight		Vacuum Rating		Crimp Solution	
	Standard Cover	Tough Cover	Super Tough	inch	mm	inch	mm	psi	MPa	inch	mm	lbs/ft	kg/m	inches of Hg	kPa	Parkrimp 43 Series	Variable Crimper 43 Series
	187	187TC	187ST	ISO 18752 Performance													
187-8	AC	AC	AC	1/2	12,5	0.81	21	1000	7,0	2-1/2	65	0.29	0,43	24	80	•	
187-10	AC	AC	AC	5/8	16,0	0.93	24	1000	7,0	3	75	0.33	0,49	24	80	•	
187-12	AC	AC	AC	3/4	19,0	1.08	27	1000	7,0	3-1/2	90	0.42	0,63	24	80	•	
187-16	AC	AC	AC	1	25,0	1.41	36	1000	7,0	4-1/2	114	0.61	0,91	24	80	•	
187-20	AC	AC	AC	1-1/4	31,5	1.75	44	1000	7,0	5-1/2	140	1.24	1,85	18	60	•	
187-24	AC	AC	AC	1-1/2	38,0	2.04	52	1000	7,0	9-3/4	248	1.32	1,96	18	60	•	
187-32	AC	AC	AC	2	51,0	2.54	65	1000	7,0	12-1/2	318	1.75	2,60	18	60	•	
187-40	AS	AS	AS	2-1/2	63,5	2.97	75	1000	7,0	20	508	2.04	3,04	18	60		•
187-48	AS	AS	AS	3	76,0	3.54	91	1000	7,0	20	508	2.77	4,12	18	60		•

**Application:** Petroleum base hydraulic fluids and lubricating oils.

**Inner Tube:** Synthetic rubber.

**Reinforcement:** One- or two-braided steel wires.

**Cover:** Standard Cover: Synthetic rubber.  
 ToughCover: Synthetic rubber abrasion resistant.  
 SuperTough Cover: Synthetic rubber super abrasion resistant.

**Fittings:** 43 Series - pg. B-27.

**Temperature Range:** Standard Cover: -40°F to +212°F (-40°C to +100°C).  
 ToughCover & SuperTough Cover: -40°F to +257°F (-40°C to +125°C).  
 For -40 & -48 sizes only -40°F to +212°F (-40°C to +100°C).

**WARNING:** This product can expose you to chemicals including Carbon Black, which is known to the State of California to cause cancer. For more information go to [www.p65warnings.ca.gov](http://www.p65warnings.ca.gov).

# HYDRAULIC

# 387

## Markets



Parker's GlobalCore 387 Hose provides 3,000 psi (21 MPa) constant working pressure in sizes -4 through -32. With a lightweight, flexible design, 387 Hose improves routing capabilities and maximizes efficiency across sizes and markets.

- ½ ISO 18752 minimum bend radius
- Low force to flex for ease of installation
- Exceeds ISO 18752 performance specification (AC, BC and CC)
- Synthetic rubber inner tube provides a wider range of fluid compatibility
- TC cover provides 80 times and ST cover 450 times abrasion resistance when compared to standard covers

## Performance

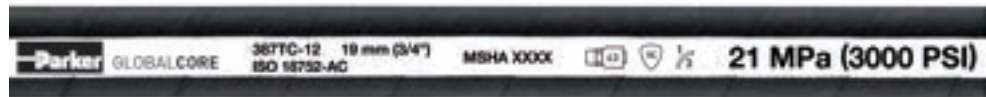

## 387 Hydraulic – Constant Working Pressure ISO 18752



[view on web page](#)

# Part Number	Standard Cover	TC Tough Cover	ST Super Tough	Hose I.D.		Hose O.D.		Working Pressure		Minimum Bend Radius		Weight		Hg Vacuum Rating		Parkrimp 43 Series	Parkrimp 77 Series
	387	387TC	387ST	inch	mm	inch	mm	psi	MPa	inch	mm	lbs/ft	kg/m	inches of Hg	kPa		
387-4	AC	AC	AC	1/4	6,3	0.53	13,4	3000	21,0	2	50	0.16	0,24	24	80	●	
387-6	AC	AC	AC	3/8	10	0.69	17,4	3000	21,0	2-1/2	65	0.23	0,34	24	80	●	
387-8	AC	AC	AC	1/2	12,5	0.82	20,7	3000	21,0	3-1/2	90	0.29	0,43	24	80	●	
387-10	AC	AC	AC	5/8	16	0.94	23,9	3000	21,0	4	100	0.33	0,49	24	80	●	
387-12	AC	AC	AC	3/4	19	1.10	27,8	3000	21,0	4-3/4	120	0.58	0,86	24	80	●	
387-16	AC	AC	AC	1	25	1.40	35,4	3000	21,0	6	150	0.79	1,17	24	80	●	
387-20	BC	CC	CC	1-1/4	31,5	1.82	46,3	3000	21,0	8-1/4	210	1.74	2,59	18	60	●	●
387-24	BC	CC	CC	1-1/2	38	2.08	52,8	3000	21,0	10	250	2.01	2,99	18	60		●
387-32	BC	CC	CC	2	51	2.61	66,2	3000	21,0	12-1/2	320	2.75	4,09	18	60		●

**Application:** Petroleum base hydraulic fluids and lubricating oils.

**Inner Tube:** Synthetic rubber.

**Reinforcement:** One-braid steel wire for sizes -4 to -8.  
Two-braid steel wire for sizes -10 to -16.  
Four-spiral steel wire for sizes -20 to -32.

**Cover:** Standard Cover: Synthetic rubber.  
ToughCover: Synthetic rubber abrasion resistant.  
SuperTough Cover: Synthetic rubber super abrasion resistant.

**Fittings:** 43 Series, sizes -4 to -20 - pg. B-27.  
77 Series, sizes -20 to -32 - pg. B-90.

**Temperature Range:** Standard Cover: -40°F to +212°F (-40°C to +100°C).  
ToughCover & SuperTough Cover: -40°F to +257°F (-40°C to +125°C).

**WARNING:** This product can expose you to chemicals including Carbon Black, which is known to the State of California to cause cancer. For more information go to [www.p65warnings.ca.gov](http://www.p65warnings.ca.gov).

# HYDRAULIC

# 487

## Markets

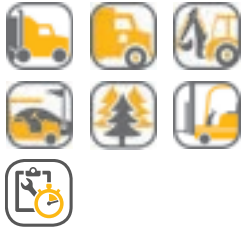

Parker's GlobalCore 487 Hose provides 4,000 psi (28 MPa) constant working pressure in sizes -4 through -32. Constructed for high performance, 487 Hose is designed for easy installation and handling in even the toughest applications. Highly flexible across all sizes, 487 Hose excels in multiple applications around the world.

- ½ ISO 18752 minimum bend radius
- Low force to flex for ease of installation
- Exceeds ISO 18752 performance specification (AC, BC & CC)
- TC cover provides 80 times and ST cover 450 times abrasion resistance when compared to standard covers

## Performance



## 487 Hydraulic – Constant Working Pressure ISO 18752



[view on web page](#)

# Part Number	Cover			Hose I.D.		Hose O.D.		Working Pressure		Minimum Bend Radius		Weight		Fittings	
	Standard Cover 487	Tough Cover 487TC	Super Tough 487ST	inch	mm	inch	mm	psi	MPa	inch	mm	lbs/ft	kg/m	Parkrimp 43 Series	Parkrimp 77 Series
487-4	AC	AC	AC	1/4	6,3	0.52	13,1	4000	28,0	2	50	0.20	0,30	●	
487-6	AC	AC	AC	3/8	10	0.68	17,2	4000	28,0	2-1/2	65	0.28	0,42	●	
487-8	AC	AC	AC	1/2	12,5	0.81	20,4	4000	28,0	3-1/2	90	0.35	0,52	●	
487-10	AC	AC	AC	5/8	16	0.94	23,9	4000	28,0	4	100	0.44	0,66	●	
487-12	AC	AC	AC	3/4	19	1.10	27,8	4000	28,0	4-3/4	120	0.58	0,86	●	
487-16	BC	CC	CC	1	25	1.49	37,8	4000	28,0	6	150	1.34	1,99	●	
487-20	BC	CC	CC	1-1/4	31,5	1.82	46,3	4000	28,0	8-1/4	210	1.74	2,59		●
487-24	BC	CC	CC	1-1/2	38	2.03	52,8	4000	28,0	10	250	2.07	3,08		●
487-32	BC	CC	CC	2	51	2.65	67,3	4000	28,0	12-1/2	320	4.35	6,47		●

**Application:** Petroleum base hydraulic fluids and lubricating oils.

**Inner Tube:** Synthetic rubber.

**Reinforcement:** Two-braid steel wire for sizes -4 to -12.  
Four-spiral steel wire for sizes -16 to -24.  
Six-spiral steel wire for size -32.

**Cover:** Standard Cover: Synthetic rubber.  
ToughCover: Synthetic rubber abrasion resistant.  
SuperTough Cover: Synthetic rubber super abrasion resistant.

**Fittings:** 43 Series, sizes -4 to -16 - pg. B-27.  
77 Series, sizes -20 to -32 - pg. B-90.

**Temperature Range:** Standard Cover: -40°F to +212°F (-40°C to +100°C).  
ToughCover & SuperTough Cover: -40°F to +257°F (-40°C to +125°C).

**⚠ WARNING:** This product can expose you to chemicals including Carbon Black, which is known to the State of California to cause cancer. For more information go to [www.p65warnings.ca.gov](http://www.p65warnings.ca.gov).

A

# HYDRAULIC 722

## Markets

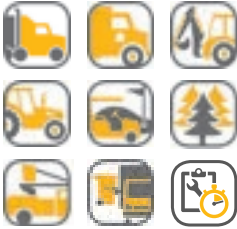

Parker's GlobalCore 722 Hose provides 4,000 psi (28 MPa) constant working pressure in sizes -6 through -16. Designed for high-pressure, high-impulse applications, 722 Hose delivers maximum performance and efficiency. The 4-spiral construction of 722 Hose ensures ease of installation while reducing the amount of hose needed for your application.

- ½ ISO 18752 minimum bend radius
- Exceeds ISO 18752 performance specification (BC and CC)
- 4-spiral construction for longer life in high-impulse, heavy-duty cycle applications
- TC cover provides 80 times and ST cover 450 times abrasion resistance when compared to standard covers

B

## Performance



C

## 722 Hydraulic – Constant Working Pressure ISO 18752



[view on web page](#)

D

# Part Number	Cover			Hose I.D.		Hose O.D.		Working Pressure		Minimum Bend Radius		Weight		Parkrimp 43 Series
	Standard Cover	Tough Cover	Super Tough	inch	mm	inch	mm	psi	MPa	inch	mm	lbs/ft	kg/m	
	722	722TC	722ST	ISO 18752 Performance										
722-6	BC	CC	CC	3/8	10	0.78	19,9	4000	28,0	2-1/2	65	0.40	0,60	●
722-8	BC	CC	CC	1/2	12,5	0.89	22,7	4000	28,0	3-1/2	90	0.54	0,80	●
722-10	BC	CC	CC	5/8	16	1.04	26,4	4000	28,0	4	100	0.74	1,10	●
722-12	BC	CC	CC	3/4	19	1.21	30,7	4000	28,0	4-3/4	120	0.94	1,40	●
722-16	BC	CC	CC	1	25	1.50	37,8	4000	28,0	6	150	1.34	1,99	●

E

**Application:** Petroleum base hydraulic fluids and lubricating oils.

**Inner Tube:** Synthetic rubber.

**Reinforcement:** Four-spiral steel wire.

**Cover:** Standard Cover: Synthetic rubber.

ToughCover: Synthetic rubber abrasion resistant.

SuperTough Cover: Synthetic rubber super abrasion resistant.

**Fittings:** 43 Series - pg. B-27.

**Temperature Range:** Standard Cover: -40°F to +212°F (-40°C to +100°C) - BC.

ToughCover & SuperTough Cover: -40°F to +257°F (-40°C to +125°C).

**WARNING:** This product can expose you to chemicals including Carbon Black, which is known to the State of California to cause cancer. For more information go to [www.p65warnings.ca.gov](http://www.p65warnings.ca.gov).

# HYDRAULIC

# 787

## Markets

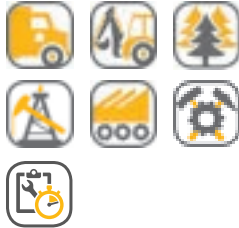

Parker's GlobalCore 787 hose provides 5,000 psi (35 MPa) constant working pressure in sizes -4 through -32. With a Compact Spiral design that offers greater advantages in routing and installation, 787 hose delivers superior performance in a lightweight, force-to-flex product.

- ½ ISO 18752 minimum bend radius
- Meets ISO 18752 performance specification
- Nearly 30% smaller O.D. by area than SAE spiral
- Twice the impulse/life – tested up to 2,000,000 cycles
- Flex impulse tested providing a hose superior in both performance and service life
- Weighs less than SAE spiral hose
- TC cover provides 80 times and ST cover 450 times abrasion resistance when compared to standard covers

## Performance



## 787 Hydraulic – Constant Working Pressure ISO 18752



view on web page

# Part Number	Cover			Hose I.D.		Hose O.D.		Working Pressure		Minimum Bend Radius		Weight		Parkrimp	
	Standard Cover	Tough Cover	Super Tough Cover												
	787	787TC	787ST	inch	mm	inch	mm	psi	MPa	inch	mm	lbs/ft	kg/m	43 Series	77 Series
787-4	AC	AC	AC	1/4	6,3	0.51	13,0	5000	35,0	2	50	0.21	0.31	•	
787-6	AC	AC	AC	3/8	10	0.68	17,2	5000	35,0	2-1/2	63	0.28	0,42	•	
787-8	BC	DC	DC	1/2	12,5	0.83	21,1	5000	35,0	3-1/2	90	0.45	0,67		•
787-10	BC	DC	DC	5/8	16	0.94	23,9	5000	35,0	4	100	0.54	0,80		•
787-12	BC	DC	DC	3/4	19	1.10	27,9	5000	35,0	4-3/4	120	0.78	1,16		•
787-16	BC	DC	DC	1	25	1.40	35,7	5000	35,0	6	150	1.17	1,74		•
787-20	BC	DC	DC	1-1/4	31,5	1.77	44,9	5000	35,0	8-1/4	210	1.95	2,89		•
787-24	BC	DC	DC	1-1/2	38	2.08	52,8	5000	35,0	10	255	2.66	3,96		•
787-32	BC	DC	DC	2	51	2.66	67,6	5000	35,0	12-1/2	318	4.37	6,50		•

**Application:** Petroleum base hydraulic fluids and lubricating oils.

**Inner Tube:** Proprietary synthetic rubber.

**Reinforcement:** Two-braid steel wire for sizes -4 to -6,  
Four- or six-compact spiral steel wires for sizes -8 to -32.

**Cover:** Standard Cover: Synthetic rubber.  
ToughCover: Synthetic rubber abrasion resistant.  
SuperTough Cover: Synthetic rubber super abrasion resistant.

**Fittings:** 43 Series: sizes -4 to -6 - pg. B-27.  
77 Series: sizes -8 to -32 - pg. B-90.

**Temperature Range:** Standard Cover:  
-40°F to +212°F (-40°C to +100°C).  
ToughCover & SuperTough Cover:  
-40°F to +257°F (-40°C to +125°C).  
(-4 to -6 rated to +212°F).

**WARNING:** This product can expose you to chemicals including Carbon Black, which is known to the State of California to cause cancer. For more information go to [www.p65warnings.ca.gov](http://www.p65warnings.ca.gov).

# HYDRAULIC

# 797

## Markets

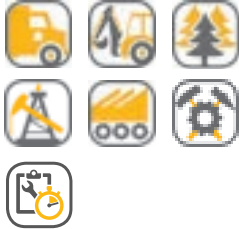

Parker's GlobalCore 797 hose provides 6,000 psi (42 MPa) constant working pressure in sizes -4 through -32. Tested up to 2,000,000 cycles, 797 hose provides superior performance and service life with an easy-to-install compact spiral construction for high-pressure, high-impulse applications.

- Meets ISO 18752 performance specification
- Nearly 30% smaller O.D. by area than SAE spiral
- Twice the impulse/life – tested up to 2,000,000 cycles
- Flex impulse tested providing a hose superior in both performance and service life
- Weighs less than SAE spiral hose
- TC cover provides 80 times and ST cover 450 times abrasion resistance when compared to standard covers

## Performance

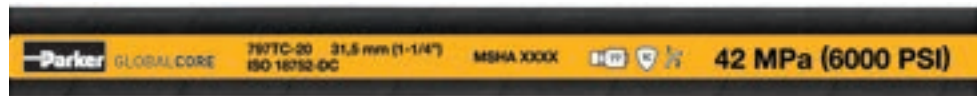

## 797

### Hydraulic – Constant Working Pressure

ISO 18752



[view on web page](#)

# Part Number	Standard Cover	TC Tough Cover	ST Super Tough Cover	Hose I.D.		Hose O.D.		Working Pressure		Minimum Bend Radius		Weight		Parkrimp	Parkrimp
	797	797TC	797ST	inch	mm	inch	mm	psi	MPa	inch	mm	lbs/ft	kg/m	43 Series	77 Series
	ISO 18752 Performance														
797-4	AC	AC	AC	1/4	6,3	0.51	13,0	6000	42,0	2	50	0.21	0,31	•	
797-6	BC	CC	CC	3/8	10	0.66	17,0	6000	42,0	2-1/2	63	0.31	0,46	•	
797-8	BC	DC	DC	1/2	12,5	0.83	21,1	6000	42,0	4	100	0.45	0,67		•
797-10	BC	DC	DC	5/8	16	0.94	23,9	6000	42,0	4-1/2	115	0.54	0,80		•
797-12	BC	DC	DC	3/4	19	1.10	27,9	6000	42,0	5-1/4	135	0.78	1,16		•
797-16	BC	DC	DC	1	25	1.40	35,7	6000	42,0	6-1/2	165	1.17	1,74		•
797-20	BC	DC	DC	1-1/4	31,5	1.77	44,9	6000	42,0	8-3/4	225	1.95	2,89		•
797-24	BC	CC	CC	1-1/2	38	2.08	52,8	6000	42,0	12	305	2.66	3,96		•
797-32	BC	CC	CC	2	51	2.66	67,6	6000	42,0	15	380	4.37	6,50		•

**Application:** Petroleum base hydraulic fluids and lubricating oils.

**Inner Tube:** Proprietary synthetic rubber.

**Reinforcement:** Two-braid steel wire for size -4, Four- or six-compact spiral steel wires for sizes -6 to -32.

**Cover:** Standard Cover: Synthetic rubber.  
ToughCover: Synthetic rubber abrasion resistant.  
SuperTough Cover: Synthetic rubber super abrasion resistant.

**Fittings:** 43 Series: sizes -4 to -6 - pg. B-27.  
77 Series: sizes -8 to -32 - pg. B-90.

**Temperature Range:** Standard Cover: -40°F to +212°F (-40°C to +100°C).  
ToughCover & SuperTough Cover: -40°F to +257°F (-40°C to +125°C). (-4 rated to +212°F).

**WARNING:** This product can expose you to chemicals including Carbon Black, which is known to the State of California to cause cancer. For more information go to [www.p65warnings.ca.gov](http://www.p65warnings.ca.gov).



# HYDRAULIC

# JK – Jack Hose

## Markets



Parker Jack Hose should be your choice for use on hydraulically powered jacking equipment. From its engineered inner tube, and twin braids of high-tensile steel reinforcement, to its durable outer cover, our hydraulic Jack Hose has been designed for high performance, easily supporting the rigors of high tonnage hydraulic jack applications. Jack Hose comes with the added benefits of the world’s largest distributor network and Parker’s unequalled technical services.

- 10,500 max working pressure
- Engineered inner tube provides exceptional hydraulic fluid compatibility
- No-Skive design eliminates the need to remove hose cover before crimping



view on web page

## JK

### Hydraulic – Jack Hose

ISO 1436-1 TYPE 2SN / SAE J517 100R2AT / EN 853 TYPE 2SN / NFPA 1936 / EES 116-4

# Part Number	Hose I.D.		Hose O.D.		Working Pressure		Minimum Bend Radius		Weight		Parkrimp 43 Series
	inch	mm	inch	mm	psi	MPa	inch	mm	lbs/ft	kg/m	
JK-4	1/4	6,3	0.59	15	10500	72,4	4	100	0.26	0,39	●
JK-6	3/8	10	0.75	19	10000	70	5	125	0.37	0,55	●

NOTE: THIS PRODUCT CAN ONLY BE ASSEMBLED BY CERTIFIED DISTRIBUTORS OR CUSTOMERS ACCORDING TO THE METHODS PRESCRIBED IN BULLETIN 4480-T18-US. JK HOSE HAS A 2:1 DESIGN FACTOR.

**Application:** Petroleum base hydraulic fluids and lubricating oils.

**Inner Tube:** Synthetic rubber.

**Reinforcement:** Two braids steel wire.

**Cover:** Synthetic rubber, MSHA accepted.

**Temperature Range:** -40°F to +120°F (-40°C to +49°C).

**Fittings:** 10143-4-4, 10143-4-6, 10143-6-4, 10143-6-6 pg. B-30.

- See Section C for Parkrimp Assembly Instructions.
- Temperature Range of other media listed in Section E.

**WARNING:** This product can expose you to chemicals including Carbon Black, which is known to the State of California to cause cancer. For more information go to [www.p65warnings.ca.gov](http://www.p65warnings.ca.gov).

# HYDRAULIC 422

## Markets



Parker's worldwide hose line is designed to accommodate global customer requirements. Manufactured to strict international specifications, 422 hose offers customers consistency of performance combined with improved availability anywhere in the world.

- One-wire braid hose design manufactured to international specifications (ISO 1436-1 Type 1SN)
- Increased working pressures for improved reliability and expanded applications versus standard SAE 100R1
- Synthetic rubber inner tube for greater fluid compatibility and bio-oil resistance



[view on web page](#)

## 422 Hydraulic Worldwide

ISO 1436-1 TYPE 1SN / SAE J517 100R1AT / SAE J1942 / EN 853 TYPE 1SN

# Part Number	Hose I.D.		Hose O.D.		Working Pressure		Minimum Bend Radius		Weight		Vacuum Rating		Parkrimp	Field Attachable
	inch	mm	inch	mm	psi	MPa	inch	mm	lbs/ft	kg/m	inches of Hg	kPa	43 Series	42 Series
422-4	1/4	6,3	0.53	13	3250	22,5	4	100	0.16	0,24	24	81	•	•
422-5	5/16	6,3	0.59	15	3125	21,5	4-1/2	115	0.18	0,27	24	81	•	•
422-6	3/8	10	0.68	17	2600	18,0	5	130	0.23	0,34	24	81	•	•
422-8	1/2	12,5	0.81	21	2325	16,0	7	180	0.29	0,43	24	81	•	•
422-10	5/8	16	0.94	24	1875	13,0	8	200	0.33	0,49	24	81	•	•
422-12	3/4	19	1.09	28	1525	10,5	9-1/2	240	0.42	0,63	24	81	•	•
422-16	1	25	1.41	36	1275	8,8	12	300	0.63	0,94	24	81	•	•
422-20	1-1/4	31,5	1.79	45	900	6,3	16-1/2	420	0.8	1,19	18	61	•	•
422-24	1-1/2	38	2	51	725	5,0	20	500	1	1,49	18	61	•	•
422-32	2	51	2.54	64	575	4,0	25	630	1.5	2,24	18	61	•	•

**Application:** Petroleum base hydraulic fluids and lubricating oils.

**Inner Tube:** Synthetic rubber.

**Reinforcement:** One braid steel wire.

**Cover:** Synthetic rubber.

**Temperature Range:** -40°F to +212°F (-40°C to +100°C).

**Fittings:** 43 Series - pg. B-27.  
42 Series - pg. B-173.

- Field Attachable Assembly Instructions are in Section B with each Fittings Series.
- See Section C for Parkrimp Assembly Instructions.
- Temperature Range of other media listed in Section E.

**WARNING:** This product can expose you to chemicals including Carbon Black, which is known to the State of California to cause cancer. For more information go to [www.p65warnings.ca.gov](http://www.p65warnings.ca.gov).

# HYDRAULIC

# 482TC/ST

## Markets

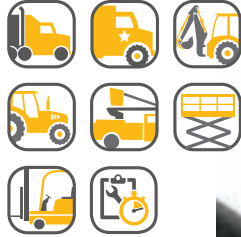

Parker's 482 hose is a hydraulic industry standard hose that has a pressure range of 1275-3250 psi, with a synthetic rubber inner tube which provides wide fluid compatibility.

- 1/2 minimum bend radius for ease of routing
- Meets SAE 100R1 specification



## Performance



### 482TC

#### Hydraulic – ToughCover

ISO 1436-1 TYPE 1SN / SAE J517 100R1AT / SAE J1942 / EN 853 TYPE 1SN



[view on web page](#)

### 482ST

#### Hydraulic – SuperTough Cover

ISO 1436-1 TYPE 1SN / SAE J517 100R1AT / EN 853 TYPE 1SN



[view on web page](#)

# Part Number	Hose I.D.		Hose O.D.		Working Pressure		Minimum Bend Radius		Weight		Parkrimp 43 Series	Attachable 42 Series
	inch	mm	inch	mm	psi	MPa	inch	mm	lbs/ft	kg/m		
482TC/ST-4	1/4	6,3	0.53	14	3250	22,7	2	50	0.16	0,24	●	●
482TC-5	5/16	8	0.59	15	3250	22,7	2-1/4	55	0.18	0,27	●	●
482TC/ST-6	3/8	10	0.69	17	3000	21,0	2-1/2	65	0.23	0,34	●	●
482TC/ST-8	1/2	12,5	0.82	21	2500	17,5	3-1/2	90	0.29	0,43	●	●
482TC/ST-10	5/8	16	0.94	24	2000	14,0	4	100	0.33	0,49	●	●
482TC/ST-12	3/4	19	1.09	28	1750	12,2	4-3/4	120	0.42	0,63	●	●
482TC/ST-16	1	25	1.41	36	1275	8,8	6	150	0.63	0,94	●	●

**Application:** Petroleum base hydraulic fluids and lubricating oils.

**Inner Tube:** Synthetic rubber.

**Reinforcement:** One braid steel wire.

**Cover:** Synthetic rubber abrasion resistant, MSHA accepted.

**Temperature Range:** -40°F to +212°F (-40°C to +100°C).

**Fittings:** 43 Series - pg. B-27.  
42 Series - pg. B-173.

- Field Attachable Assembly Instructions are in Section B with each Fittings Series.
- See Section C for Parkrimp Assembly Instructions.
- Temperature Range of other media listed in Section E.

**WARNING:** This product can expose you to chemicals including Carbon Black, which is known to the State of California to cause cancer. For more information go to [www.p65warnings.ca.gov](http://www.p65warnings.ca.gov).

# HYDRAULIC

# 426

## Markets



Parker's 426 hose is a hydraulic industry standard hose that has a pressure range of 375-2750 psi, which is designed for high-temperature applications up to 302°F. The 426 hose is designed, built, and tested to meet SAE J517 100R1AT and SAE J1942 specifications.

- Engine compartment applications
- Meets SAE 100R1 specification
- Distinctive blue cover indicates high temperature rating
- Temperature up to 302° F

## Performance



## 426

Hydraulic – High-Temperature  
SAE J517 100R1AT / SAE J1942



[view on web page](#)

# Part Number	Hose I.D.		Hose O.D.		Working Pressure		Minimum Bend Radius		Weight		Parkrimp 43 Series
	inch	mm	inch	mm	psi	MPa	inch	mm	lbs/ft	kg/m	
426-4	1/4	6,3	0.53	13	2750	19,2	4	100	0.16	0,24	●
426-6	3/8	10	0.68	17	2250	15,7	5	125	0.23	0,34	●
426-8	1/2	12,5	0.81	21	2000	14,0	7	180	0.29	0,43	●
426-10	5/8	16	0.94	24	1500	10,5	8	200	0.33	0,49	●
426-12	3/4	19	1.09	28	1250	8,7	9-1/2	240	0.44	0,65	●
426-16	1	25	1.40	36	1000	7,0	12	300	0.66	0,98	●
426-20	1-1/4	31,5	1.79	45	625	4,3	16-1/2	420	0.94	1,40	●
426-24	1-1/2	38	2.00	51	500	3,5	20	500	0.98	1,46	●
426-32	2	51	2.54	64	375	2,6	25	630	1.46	2,18	●

**Application:** Petroleum base hydraulic fluids and lubricating oils.

**Inner Tube:** PKR®.

**Reinforcement:** One braid steel wire.

**Cover:** PKR® rubber, blue, MSHA accepted.

**Temperature Range:** -50°F to +302°F (-46°C to +150°C).

**Fittings:** 43 Series - pg. B-27.

- See Section C for Parkrimp Assembly Instructions.
- Temperature Range of other media listed in Section E.

**WARNING:** This product can expose you to chemicals including Carbon Black, which is known to the State of California to cause cancer. For more information go to [www.p65warnings.ca.gov](http://www.p65warnings.ca.gov).

# HYDRAULIC 302

## Markets



Parker's 302 hose, a universal two-wire construction hose designed to accommodate global customer requirements, is manufactured to strict international quality specifications. Parker's 302 offers customers consistency of performance combined with continuous availability anywhere in the world. It offers a high working pressure, long service life and a wide fluid compatibility.

- Universal two-wire hose design manufactured to international specifications (ISO 1436-1 Type 2SN)
- Increased working pressures for improved reliability and expanded applications
- Synthetic rubber inner tube for greater fluid compatibility and bio-oil resistance

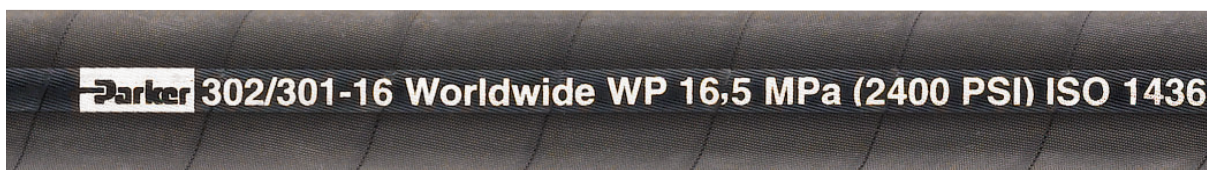

[view on web page](#)

## 302 Hydraulic Worldwide

ISO 1436-1 TYPE 2SN / SAE J517 100R2AT / SAE J1942 / EN 853 TYPE 2SN

# Part Number	Hose ID		Hose O.D.		Working Pressure		Minimum Bend Radius		Weight		Hg Vacuum Rating		Parkrimp 43 Series	Field Attachable 30 Series
	inch	mm	inch	mm	psi	Mpa	inch	mm	lbs/ft	kg/m	inches of Hg	kPa		
302-4	1/4	6,3	0.59	15,0	5800	40	4	100	0.26	0,39	28	95	•	•
302-5	5/16	8	0.65	16,6	5000	35	4-1/2	115	0.28	0,42	28	95	•	•
302-6	3/8	10	0.75	19,0	4750	33	5	130	0.37	0,55	28	95	•	•
302-8	1/2	12,5	0.88	22,3	4000	28	7	180	0.45	0,67	28	95	•	•
302-10	5/8	16	1.00	25,5	3600	25	8	200	0.52	0,77	28	95	•	•
302-12	3/4	19	1.16	29,4	3100	21,5	9-1/2	240	0.67	1,00	24	80	•	•
302-16	1	25	1.50	38,1	2400	16,5	12	300	1.00	1,49	24	80	•	•
302-20	1-1/4	31,5	1.86	47,1	1800	12,5	16-1/2	420	1.16	1,73	24	80	•	•
302-24	1-1/2	38	2.14	54,5	1300	9	20	500	1.44	2,14	24	80	•	•
302-32	2	51	2.64	67,2	1150	8	25	630	1.99	2,96	24	80	•	•

**Application:** Petroleum base hydraulic fluids and lubricating oils.

**Inner Tube:** Synthetic rubber.

**Reinforcement:** Two braids steel wire.

**Cover:** Synthetic rubber.

**Temperature Range:** -40°F to +212°F (-40°C to +100°C).

**Fittings:** 43 Series - pg. B-27.  
30 Series - pg. B-167.

- Field Attachable Assembly Instructions are in Section B with each Fittings Series.
- See Section C for Parkrimp Assembly Instructions.
- Temperature Range of other media listed in Section E.

**WARNING:** This product can expose you to chemicals including Carbon Black, which is known to the State of California to cause cancer. For more information go to [www.p65warnings.ca.gov](http://www.p65warnings.ca.gov).

# HYDRAULIC

# 436

## Markets



With one-half the minimum SAE bend radius and a smaller hose O.D., 436 hose has the flexibility to work in almost any application – including tight spots. Engineered to withstand high pressure within a wide range of working temperatures, Parker's 436 hose is not only versatile, but dependable over a long hose life. For quality, service, and value, there's simply no match.

- Compact construction provides easier routing
- Temperatures up to 302° F
- Distinctive blue cover indicates high temperature capability
- Reduced bend radius and excellent flexibility
- 2-wire braided reinforcement with smaller construction
- Meets SAE 100R16 / ISO 11237 Type R16 specifications

## Performance



## 436

**Hydraulic – Compact High Temperature**  
ISO 11237 TYPE R16 / SAE J517 100R16

**BLU** **BLK**



[view on web page](#)

# Part Number	Hose I.D.		Hose O.D.		Working Pressure		Minimum Bend Radius		Weight		Parkrimp	Field Attachable
	inch	mm	inch	mm	psi	MPa	inch	mm	lbs/ft	kg/m	43 Series	42 Series
436-6	3/8	10	0.68	17	4000	27,5	2-1/2	65	0.28	0,42	●	●
436-8	1/2	12,5	0.81	21	3500	24	3-1/2	90	0.34	0,51	●	●
436-10	5/8	16	0.94	24	2750	19	4	100	0.44	0,66	●	●
436-12	3/4	19	1.09	28	2250	15,5	4-3/4	120	0.54	0,80	●	●
436-16	1	25	1.41	36	2000	13,8	6	150	0.82	1,22	●	●

**Application:** Petroleum base hydraulic fluids and lubricating oils.

**Inner Tube:** PKR®.

**Reinforcement:** Two braids steel wire.

**Cover:** PKR® rubber, blue, MSHA accepted.

**Temperature Range:** -55°F to +302°F (-48°C to +150°C).

**Fittings:** 43 Series - pg. B-27.  
42 Series - pg. B-173.

- Field Attachable Assembly Instructions are in Section B with each Fittings Series.
- See Section C for Parkrimp Assembly Instructions.
- Temperature Range of other media listed in Section E.

**WARNING:** This product can expose you to chemicals including Carbon Black, which is known to the State of California to cause cancer. For more information go to [www.p65warnings.ca.gov](http://www.p65warnings.ca.gov).

# HYDRAULIC 471TC/ST

## Markets



Parker's 471TC/ST hose is a hydraulic industry standard hose that has a pressure range of 2500-5800 psi, with a synthetic rubber inner tube which provides wide fluid compatibility. The two-wire braided construction offers more flexibility than the standard spiral counterpart in order to fit your needs.

- Smaller O.D. for ease of installation
- Approved with 43 Series fittings
- Provides 1/2 minimum bend radius



## Performance



### 471TC

#### Hydraulic – ToughCover

ISO 11237 TYPE 2SC / SAE J1942 / EN 857 TYPE 2SC

### 471ST

#### Hydraulic – SuperTough Cover

ISO 11237 TYPE 2SC / SAE J1942 / EN 857 TYPE 2SC



# Part Number	Hose I.D.		Hose O.D.		Working Pressure		Minimum Bend Radius		Weight		Vacuum Rating		Parkrimp 43 Series
	inch	mm	inch	mm	psi	MPa	inch	mm	lbs/ft	kg/m	inches of Hg	kPa	
471TC/ST-4	1/4	6,3	0.51	13	5800	40,0	2	50	0.20	0,30	28	95	●
471TC/ST-6	3/8	10	0.68	17	5000	35,0	2-1/2	65	0.28	0,42	28	95	●
471TC/ST-8	1/2	12,5	0.80	20	4250	29,7	3-1/2	90	0.35	0,52	28	95	●
471TC/ST-10	5/8	16	0.94	24	3625	25,0	4	100	0.44	0,66	28	95	●
471TC/ST-12	3/4	19	1.09	28	3125	21,5	4-3/4	120	0.58	0,86	24	80	●
471TC/ST-16	1	25	1.40	35	2500	17,5	6	150	0.79	1,17	24	80	●

For larger sizes see 472TC.

**Application:** Petroleum base hydraulic fluids and lubricating oils.

**Inner Tube:** Synthetic rubber.

**Reinforcement:** Two braids steel wire.

**Cover:** Synthetic rubber abrasion resistant, MSHA accepted.

**Temperature Range:** -40°F to +212°F (-40°C to +100°C).

**Fittings:** 43 Series - pg. B-27.

- See Section C for Parkrimp Assembly Instructions.
- Temperature Range of other media listed in Section E.

**WARNING:** This product can expose you to chemicals including Carbon Black, which is known to the State of California to cause cancer. For more information go to [www.p65warnings.ca.gov](http://www.p65warnings.ca.gov).

A

B

C

D

E

A

# HYDRAULIC 471TC Twin Tough

## Markets



Twin Tough hoses eliminate the labor and material costs required to manually bundle two separate hoses using tie straps or plastic sleeves. Plus, Parker's Twin Tough saves valuable time in the field.

- 5000 psi constant working pressure in -6-6 and 4000 psi in -8-8
- Two-wire braided construction
- Abrasion-resistant TC cover

B

## Performance



**471TC**  
**Hydraulic – Twin Tough Cover**  
 ISO 11237 TYPE 2SC / SAE J1942 / EN 857 TYPE 2SC



[view on web page](#)

C

# Part Number	Hose I.D.		Hose O.D.		Working Pressure		Minimum Bend Radius		Weight		Parkrimp 43 Series
	inch	mm	inch	mm	psi	MPa	inch	mm	lbs/ft	kg/m	
471TC-6-6	3/8	10	0.68	17	5000	35,0	2-1/2	65	0.56	0,84	●
471TC-8-8	1/2	12,5	0.80	20	4250	29,7	3-1/2	90	0.70	1,04	●

For assembly instructions see page C-19.

**Application:** Petroleum base hydraulic fluids and lubricating oils.

**Inner Tube:** Synthetic rubber.

**Reinforcement:** Two braids steel wire.

**Cover:** Synthetic rubber abrasion resistant, MSHA accepted.

**Temperature Range:** -40°F to +212°F (-40°C to +100°C).

**Fittings:** 43 Series - pg. B-27.

- See Section C for Parkrimp Assembly Instructions.
- Temperature Range of other media listed in Section E.

D

E

**WARNING:** This product can expose you to chemicals including Carbon Black, which is known to the State of California to cause cancer. For more information go to [www.p65warnings.ca.gov](http://www.p65warnings.ca.gov).



# HYDRAULIC

# 472TC

## Markets



## Performance



Parker's 472TC hose is a hydraulic industry standard hose that has a pressure range of 1300-2250 psi, which allows for one to meet the specifications of any task at hand. The 472TC is designed, built, and tested to meet SAE J1942 specifications. The two-wire braided construction offers more flexibility than the standard spiral counterpart in order to fit your needs. The synthetic rubber inner tube provides a wide range of fluid compatibility.

- Synthetic rubber inner tube provides wide fluid compatibility
- Available in larger sizes: -20, -24, -32
- 2-wire braided construction

## 472TC Hydraulic – ToughCover SAE J1942



view on web page

# Part Number	Hose I.D.		Hose O.D.		Working Pressure		Minimum Bend Radius		Weight		Parkrimp 43 Series
	inch	mm	inch	mm	psi	MPa	inch	mm	lbs/ft	kg/m	
472TC-20	1-1/4	31,5	1.79	45	2250	15,7	8-1/4	210	1.34	2,01	●
472TC-24	1-1/2	38	2.01	51	1800	12,5	10	250	1.44	2,16	●
472TC-32	2	51	2.54	65	1300	9,0	12-1/2	315	1.93	2,90	●

**Application:** Petroleum base hydraulic fluids and lubricating oils.

**Inner Tube:** Synthetic rubber.

**Reinforcement:** Two braids steel wire.

**Cover:** Synthetic rubber abrasion resistant, MSHA accepted.

**Temperature Range:** -40°F to +212°F (-40°C to +100°C).

**Fittings:** 43 Series - pg. B-27.

- See Section C for Parkrimp Assembly Instructions.
- Temperature Range of other media listed in Section E.

**WARNING:** This product can expose you to chemicals including Carbon Black, which is known to the State of California to cause cancer. For more information go to [www.p65warnings.ca.gov](http://www.p65warnings.ca.gov).

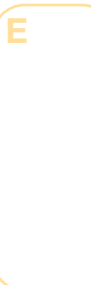

# HYDRAULIC 722TC / ST

## Markets



722TC / ST hose was designed for high performance. Its resilient 4-wire spiral construction and Parker’s leading ToughCover and SuperTough Covers provide unmatched abrasion resistance. It is also one-half the bend radius of SAE 100R12 hose, making it easy to install and reducing the amount of hose needed and its synthetic rubber inner tube provides a wider range of fluid compatibility.

- 1/2 the bend radius of SAE 100R12 hose, reducing the amount of hose needed to make your connection
- 4-spiral construction for longer lasting hose in high impulse, heavy duty cycle applications
- Synthetic rubber inner tube provides a wider range of fluid compatibility

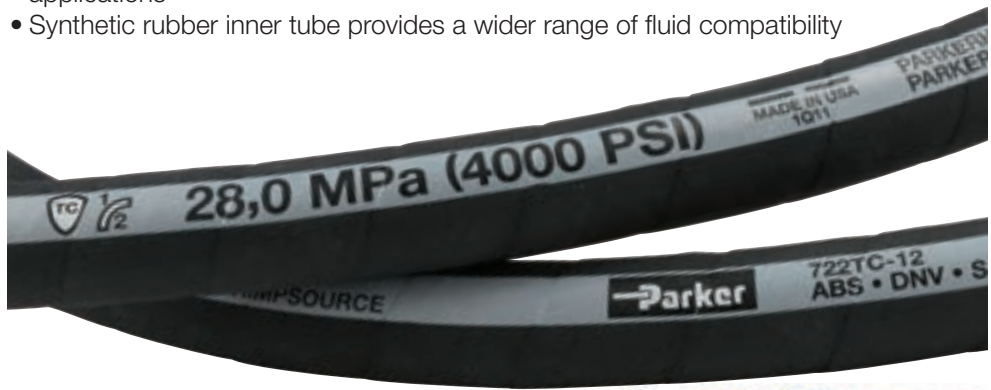

view on web page



view on web page

## Performance



## 722TC / ST

### Hydraulic – ToughCover

ISO 3862-1 TYPE R12 / SAE J517 100R12 / SAE J1942 / EN 856 TYPE R12

# Part Number	Hose I.D.		Hose O.D.		Working Pressure		Minimum Bend Radius		Weight		Parkrimp	
	inch	mm	inch	mm	psi	MPa	inch	mm	lbs/ft	kg/m	43 Series	71 Series
722TC/ST-20	1-1/4	31,4	1.84	46	3000	21,0	8-1/4	210	1.74	2,59	●	
722TC/ST-24	1-1/2	38	2.07	53	2500	17,5	10	250	2.01	2,99		●
722TC/ST-32	2	51	2.59	66	2500	17,5	12-1/2	320	2.75	4,09		●

**Application:** Petroleum base hydraulic fluids and lubricating oils.

**Inner Tube:** Synthetic rubber.

**Reinforcement:** Four spiral steel wire.

**Cover:** Synthetic rubber, MSHA accepted.

**Temperature Range:** -40°F to +257°F (-40°C to 125°C).

**Fittings:** 43 Series, sizes -6 to -20 - pg. B-27.

71 Series, size -24 to -32 - pg. B-75.

- See Section C for Parkrimp Assembly Instructions.
- Temperature Range of other media listed in Section E.

**WARNING:** This product can expose you to chemicals including Carbon Black, which is known to the State of California to cause cancer. For more information go to [www.p65warnings.ca.gov](http://www.p65warnings.ca.gov).

# HYDRAULIC 777 Hose

Parker's **777 Hose** offers innovative and proprietary features, delivering 4,000 psi and greater advantages in routing and installation. Compared with conventional spiral hose, Parker's 777 hose is lighter in weight and has a smaller outside diameter than hoses on the market.

## Performance



**777 Hose**  
4,000 psi, Reduced O.D., Reduced Weight  
ISO 18752



view on web page

# Part Number 777	S	TC	ST	Hose I.D.		Hose O.D.		Working Pressure		Minimum Bend Radius		Weight		Parkrimp 43 Series
	Standard Cover 777	Tough Cover 777TC	Super Cover 777ST	inch	mm	inch	mm	psi	MPa	inch	mm	lbs/ft	kg/m	
	ISO 18752 Performance													
777-6	BC	CC	CC	3/8	10	0.66	17.0	4000	28.0	2.00	50	0.36	0.53	●
777-8	BC	CC	CC	1/2	12.5	0.81	20.6	4000	28.0	2.80	72	0.44	0.65	●
777-10	BC	CC	CC	5/8	16	0.93	23.5	4000	28.0	3.15	80	0.56	0.83	●
777-12	BC	CC	CC	3/4	19	1.12	28.4	4000	28.0	3.80	96	0.76	1.31	●
777-16	BC	CC	CC	1	25	1.38	35.0	4000	28.0	4.75	120	0.99	1.47	●

\* Standard cover hose is rated to 212° F, Tough Cover and Super Tough covers are rated to 257 ° F



**Application:** Petroleum base hydraulic fluids and lubricating oils.

**Inner Tube:** Synthetic rubber.

**Reinforcement:** Four-spiral steel wire.

**Cover:** Standard Cover: Synthetic rubber.  
ToughCover: Synthetic rubber abrasion resistant.  
SuperTough Cover: Synthetic rubber super abrasion resistant.

**Fittings:** 43 Series - pg. B-27.

**Temperature Range:** Standard Cover: -40°F to +212°F (-40°C to +100°C) - BC.  
ToughCover & SuperTough Cover: -40°F to +257°F (-40°C to +125°C).

**WARNING:** This product can expose you to chemicals including Carbon Black, which is known to the State of California to cause cancer. For more information go to [www.p65warnings.ca.gov](http://www.p65warnings.ca.gov).

# SUCTION & RETURN 811, 811HT, 881 Suction Line

A

## Markets



Parker's 811 and 881 are suction and return line hoses that have a working pressure range of 62-300 psi as well as a vacuum rating range of 25 to 28 in/Hg. The 811HT is designed for high temperature applications.

- Up to one-half the SAE minimum bend radius for standard and high-temperature applications
- Meets or exceeds SAE 100R4 performance specifications
- Compatible with Parkrimp or field attachable fittings
- High-visibility layline
- Suitable for vacuum applications from 25 to 28 in/Hg
- Oil- and weather-resistant synthetic rubber cover
- High-temperature range for petroleum-based hydraulic fluids of -40° F to +257° F for 811HT

B

## Performance



C

**811**  
Suction and Return Line  
1/2 SAE Minimum Bend Radius  
SAE J517 100R4



[view on web page](#)

D

# Part Number	Hose I.D.		Hose O.D.		Working Pressure				Minimum Bend Radius		Weight		Vacuum Rating		Parkrimp	Field Attachable
	inch	mm	inch	mm	81/88DB psi	MPa	88HC psi	MPa	inch	mm	lbs/ft	kg/m	inches of Hg	kPa	43/81 Series	88 Series w/HC or DB
811-12	3/4	19,0	1.18	30,0	300	2,1	100	0,7	2-1/2	64	0.42	0,63	25	84	●	●
811-16	1	25,4	1.50	38,0	250	1,7	70	0,5	3	76	0.65	0,96	25	84	●	●
811-20	1-1/4	31,8	1.77	45,0	200	1,4	50	0,3	4	102	0.82	1,22	25	84	●	●
811-24	1-1/2	38,1	2.05	52,0	150	1	50	0,3	5	127	1.04	1,55	25	84	●	●
811-32	2	50,8	2.50	63,6	100	0,7	50	0,3	6	152	1.26	1,87	25	84	●	●
811-40	2-1/2	63,5	3.00	76,2	62	0,4	62	0,4	7	178	1.64	2,45	25	84	●	●

**Application:** Petroleum base hydraulic fluids and lubricating oils.

**Inner Tube:** Synthetic rubber.

**Reinforcement:** Multiple layers of fiber spiral and one helical wire.

**Cover:** Synthetic rubber.

**Temperature Range:** -40°F to +212°F (-40°C to +100°C).

**Fittings:** 81 Series - pg. B-193.  
88 Series - pg. B-193.

- Field Attachable Assembly Instructions are in Section B with each Fittings Series.
- See Section C for Parkrimp Assembly Instructions.
- Temperature Range of other media listed in Section E.

E

**WARNING:** This product can expose you to chemicals including DEHP, which is known to the State of California to cause cancer and birth defect or other reproductive harm. For more information go to [www.p65warnings.ca.gov](http://www.p65warnings.ca.gov).

## Performance



### 811HT Suction and Return Line – High-Temperature 1/2 SAE Minimum Bend Radius

SAE J517 100R4 / SAE J1942



[view on web page](#)

# Part Number	Hose I.D.		Hose O.D.		Working Pressure				Minimum Bend Radius		Weight		Vacuum Rating		Parkrimp	Field Attachable
	inch	mm	inch	mm	81/88DB		88HC		inch	mm	lbs/ft	kg/m	inches of Hg	kPa	43/81 Series	88 Series w/HC or DB
					psi	MPa	psi	MPa								
811HT-12	3/4	19,0	1.18	30,0	300	2,1	100	0,7	2-1/2	64	0.42	0,63	28	95	•	•
811HT-16	1	25,4	1.50	38,0	250	1,7	70	0,5	3	76	0.65	0,96	28	95	•	•
811HT-20	1-1/4	31,8	1.77	45,0	200	1,4	50	0,3	4	102	0.82	1,22	28	95	•	•
811HT-24	1-1/2	38,1	2.05	52,0	150	1	50	0,3	5	127	1.04	1,55	28	95	•	•
811HT-32	2	50,8	2.50	63,6	100	0,7	50	0,3	6	152	1.26	1,87	28	95	•	•
811HT-40	2-1/2	63,5	3.00	76,2	62	0,4	62	0,4	7	178	1.82	2,71	28	95	•	•

**Application:** Petroleum base hydraulic fluids and lubricating oils.

**Cover:** Synthetic rubber, MSHA accepted.

**Inner Tube:** Synthetic rubber.

**Temperature Range:** -50°F to +257°F (-46°C to +125°C).

**Reinforcement:** Multiple layers of fiber spiral and one helical wire.

**Fittings:** 81 Series - pg. B-193.  
88 Series - pg. B-193.

**⚠ WARNING:** This product can expose you to chemicals including DEHP, which is known to the State of California to cause cancer and birth defect or other reproductive harm. For more information go to [www.p65warnings.ca.gov](http://www.p65warnings.ca.gov).

### 881 Suction and Return Line

SAE J517 100R4 / SAE J1942



[view on web page](#)

# Part Number	Hose I.D.		Hose O.D.		Working Pressure				Minimum Bend Radius		Weight		Vacuum Rating		Parkrimp	Field Attachable
	inch	mm	inch	mm	43/81/88DB		88HC		inch	mm	lbs/ft	kg/m	of Hg	kPa	43/81 Series	88 Series w/HC or DB
					psi	MPa	psi	Mpa								
881-12	3/4	19,0	1.20	30,6	300	2,1	100	0,7	5	127	0.50	0,74	28	95	•	•
881-16	1	25,4	1.49	37,9	250	1,7	70	0,5	6	152	0.60	0,89	28	95	•	•
881-20	1-1/4	31,8	1.78	45,3	200	1,4	50	0,3	8	203	0.89	1,32	28	95	•	•
881-24	1-1/2	38,1	2.06	52,4	150	1	50	0,3	10	254	1.11	1,65	28	95	•	•
881-32	2	50,8	2.48	63,1	100	0,7	50	0,3	12	305	1.27	1,89	28	95	•	•
881-40	2-1/2	63,5	3.00	76,2	62	0,4	62	0,4	14	356	1.82	2,71	28	95	•	•

\*Only sizes -12 through -32 meet J1942/USCG H, HF.

**Application:** Petroleum base hydraulic fluids and lubricating oils.

**Inner Tube:** Synthetic rubber.

**Reinforcement:** Multiple layers of fiber braid and one helical wire.

**Cover:** Synthetic rubber, MSHA accepted.

**Temperature Range:** -40°F to +257°F (-40°C to +125°C).

**Fittings:** 43 Series - pg. B-27.  
81 Series - pg. B-193.  
88 Series - pg. B-193.

- Field Attachable Assembly Instructions are in Section B with each Fittings Series.
- See Section C for Parkrimp Assembly Instructions.
- Temperature Range of other media listed in Section E.

**⚠ WARNING:** This product can expose you to chemicals including DEHP, which is known to the State of California to cause cancer and birth defect or other reproductive harm. For more information go to [www.p65warnings.ca.gov](http://www.p65warnings.ca.gov).

# PUSH-LOK® 801 Multipurpose

## Markets



Parker's Push-Lok Plus multipurpose hose line features the widest fluid compatibility, application range and size range in the industry. It also incorporates the highest working pressure in all sizes, making it the most versatile general-purpose hose available. The Push-Lok system is easy to use. No clamps or special tools are required during installation. And with Parker's exclusive color-code system, you can inventory, maintain and identify your hose needs easily and efficiently. The industry's most complete line of low-pressure 801, 804 hose and fittings, Push-Lok offers the range and versatility to meet all your instrumentation needs.

- Easy assembly and organization with Parker's exclusive color-code system
- Push-Lok assemblies can be made in seconds, saving valuable time and cost
- The unique seal of Push-Lok ensures reliable, durable, leak-free service



## 801 – Push-Lok Plus®

### Multipurpose

Available Cover Colors:



[view on web page](#)

# Part Number	Hose I.D.		Hose O.D.		Working Pressure		Minimum Bend Radius		Weight		Vacuum Rating		Parkrimp	Field Attachable
	inch	mm	inch	mm	psi	MPa	inch	mm	lbs/ft	kg/m	of Hg	kPa	HY Series	82 Series
801-4	1/4	6,3	0.50	12,7	350	2,4	2-1/2	65	0.09	0,13	28	95	•	•
801-6	3/8	10	0.63	15,9	350	2,4	3	75	0.11	0,16	28	95	•	•
801-8	1/2	12,5	0.78	19,8	300	2,1	5	125	0.18	0,27	28	95	•	•
801-10	5/8	16	0.91	23,0	300	2,1	6	150	0.19	0,28	15	51	•	•
801-12	3/4	19	1.03	26,2	300	2,1	7	180	0.24	0,36	15	51	•	•
801-16	1	25	1.28	32,6	200	1,4	10	250	0.37	0,55	15	51	•	•

**Application:** Pneumatic, petroleum base hydraulic fluid, lubricating oils, and antifreeze solutions (not suitable for dry air applications).

Diesel fuel - approved only when coupled with HY Series fittings.

**Inner Tube:** Synthetic rubber.

**Reinforcement:** One fiber braid.

**Cover:** Synthetic rubber, MSHA accepted.

**Temperature Range:**

**Air:** +158°F (+70°C).

**Water:** +185°F (+85°C).

**Oil:** -40°F to 257°F (-40°C to +125°C).

**Fittings:** 82 Series - pg. B-178.

HY Series - pg. B-130.

- Field Attachable Assembly Instructions are in Section B with each Fittings Series.
- Push-Lok is not recommended for any refrigerant, or for use in air conditioners and heat pump applications.
- Push-Lok is not recommended for applications where extreme pulsation is encountered.
- Temperature Range of other media listed in Section E.
- 801 hose is not approved with any HY Series stainless steel fittings.

**WARNING:** This product can expose you to chemicals including Carbon Black, which is known to the State of California to cause cancer. For more information go to [www.p65warnings.ca.gov](http://www.p65warnings.ca.gov).

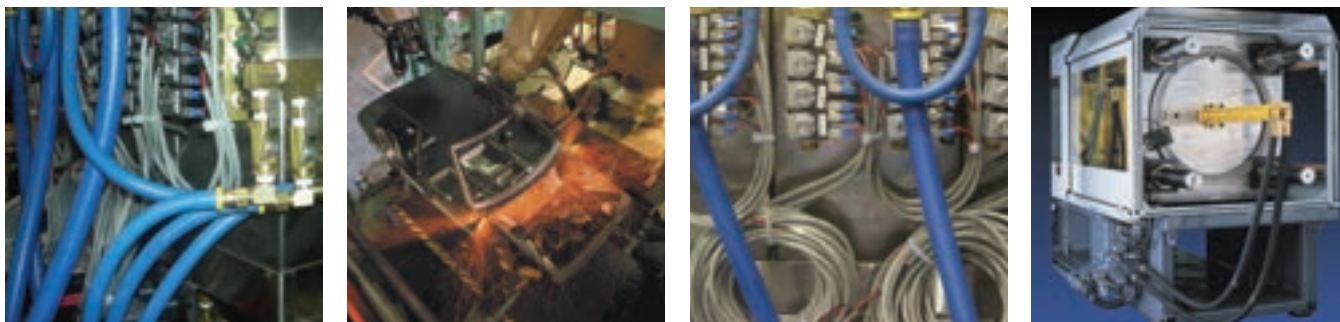

**Push-Lok Plus 801** hose provides the quick and easy assembly/disassembly advantage and the fullest range of color-coding to benefit your operations. It's now approved with both 82 Series push on and HY Series crimp fittings.

**Push-Lok Plus 804** hose features quick and easy assembly and provides an EPDM inner-tube for hot water, dry air and phosphate ester fluids. Not to be used in applications with lubricated air or media that is oil based.

**Push-Lok 821** is a higher-pressure multipurpose hose that is widely used for shop air systems and general industrial and maintenance

applications. Approved with 82 Series fittings, it's also available with a fire-resistant (FR) cover for use near welding operations.

**Push-Lok Plus 836** delivers high-temperature up to 302° F, heat-resistant performance and higher working pressures than 821, along with the same HY and 82 Series fittings compatibility.

**The color-coded advantages**

In applications where a number of hose lines carry different media, Push-Lok colors reduce timely "tracing" of lines, preventing disconnection of the wrong line and unnecessary, costly downtime.

Using color-coded Push-Lok hose is an excellent way to:

- Enhance product appearance
- Improve inventory control
- Identify industrial drop lines

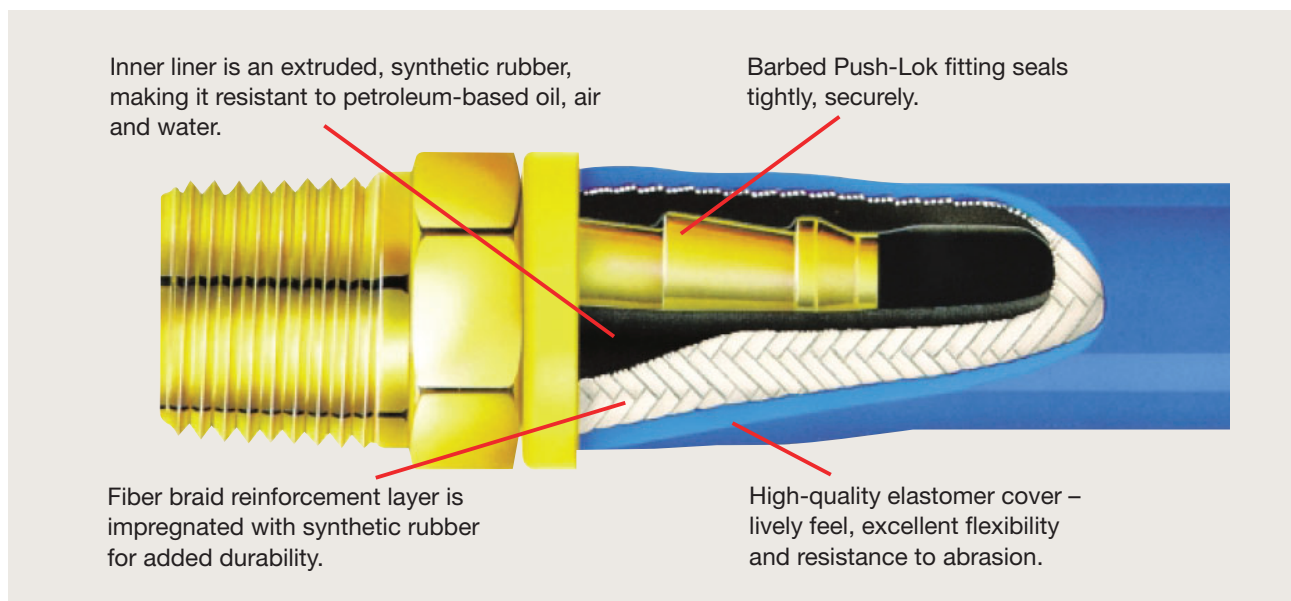

# PUSH-LOK® 836, 804 Multipurpose

## Performance



### 836 – Push-Lok Plus® Multipurpose – High-Temperature

Available Cover Colors: **BLU** **BLK**



[view on web page](#)

# Part Number	Hose I.D.		Hose O.D.		Working Pressure		Minimum Bend Radius		Weight		Vacuum Rating		Parkrimp	Field Attachable
	inch	mm	inch	mm	psi	MPa	inch	mm	lbs/ft	kg/m	inches of Hg	kPa	HY Series	82 Series
836-4	1/4	6,3	0.50	12,7	400	2,8	2-1/2	65	0.09	0,13	28	95	●	●
836-6	3/8	10	0.63	15,9	400	2,8	3	75	0.11	0,16	28	95	●	●
836-8	1/2	12,5	0.78	19,8	400	2,8	4	100	0.18	0,27	28	95	●	●
836-10	5/8	16	0.91	23,0	350	2,4	5	125	0.19	0,28	18	61	●	●
836-12	3/4	19	1.03	26,2	300	2,1	6	150	0.24	0,36	18	61	●	●

**Application:** Pneumatic, petroleum base hydraulic fluid, lubricating oils, diesel fuels and antifreeze solutions.

**Inner Tube:** PKR®.

**Reinforcement:** One fiber braid.

**Cover:** PKR, MSHA accepted.

**Temperature Range:**

**Air:** +212°F (+100°C).

**Water:** +185°F (+85°C).

**Oil:** -55°F to +302°F (-48°C to +150°C).

**Diesel fuels:** -40°C to 150°C.

(-40°F to 302°F) with HY crimps only.

**Fittings:** HY Series - pg. B-130.

82 Series - pg. B-178.

**WARNING:** This product can expose you to chemicals including Carbon Black, which is known to the State of California to cause cancer. For more information go to [www.p65warnings.ca.gov](http://www.p65warnings.ca.gov).

### 804 Dry Air/Hot Water

Available Cover Colors: **BLK**



[view on web page](#)

# Part Number	Hose I.D.		Hose O.D.		Working Pressure		Minimum Bend Radius		Weight		Vacuum Rating		Field Attachable
	inch	mm	inch	mm	psi	MPa	inch	mm	lbs/ft	kg/m	inches of Hg	kPa	82 Series
804-4	1/4	6,3	0.50	12,7	150	1,0	2-1/2	65	0.09	0,13	15	51	●
804-6	3/8	10	0.63	15,9	150	1,0	3	75	0.11	0,16	15	51	●
804-8	1/2	12,5	0.78	19,8	150	1,0	5	130	0.18	0,27	15	51	●
804-10	5/8	16	0.91	23,0	150	1,0	6	150	0.19	0,28	15	51	●

**Application:** Phosphate ester, dry air and water.

**Inner Tube:** EPDM rubber.

**Reinforcement:** One fiber braid.

**Cover:** EPDM rubber.

**Temperature Range:**

**Air:** +158°F (+70°C).

**Phosphate ester:** -40° to +176°F (-40° to +80°C).

**Water:** +200°F (+93°C).

**Fittings:** 82 Series - pg. B-178.

- Field Attachable Assembly Instructions are in Section B with each Fittings Series.
- Push-Lok is not recommended for any refrigerant, or for use in air conditioners and heat pump applications.
- Push-Lok is not recommended for applications where extreme pulsation is encountered.
- Temperature Range of other media listed in Section E.
- 836 hose is not approved with any HY Series stainless steel fittings.

**WARNING:** This product can expose you to chemicals including Carbon Black, which is known to the State of California to cause cancer. For more information go to [www.p65warnings.ca.gov](http://www.p65warnings.ca.gov).



# PUSH-LOK® 821, 821FR Multipurpose

## 821 Multipurpose

Available Cover Colors: **BLK**



[view on web page](#)

# Part Number	Hose I.D.		Hose O.D.		Working Pressure		Minimum Bend Radius		Weight		Vacuum Rating		Field Attachable 82 Series
	inch	mm	inch	mm	psi	MPa	inch	mm	lbs/ft	kg/m	inches of Hg	kPa	
821-4	1/4	6,3	0.50	12,7	350	2,4	2-1/2	64	0.06	0,09	28	95	●
821-6	3/8	10	0.63	15,9	300	2,1	3	76	0.09	0,13	28	95	●
821-8	1/2	12,5	0.78	19,8	300	2,1	5	127	0.12	0,18	28	95	●
821-10	5/8	16	0.91	23,0	250	1,7	6	152	0.19	0,28	28	95	●
821-12	3/4	19	1.03	26,2	250	1,7	7	178	0.21	0,31	28	95	●

**Application:** Pneumatic, petroleum base hydraulic fluid, lubricating oils and antifreeze solutions (not suitable for dry air applications).

**Inner Tube:** Synthetic rubber.

**Reinforcement:** One fiber braid.

**Cover:** Fiber braid.

**Temperature Range:**

**Air:** +158°F (+70°C).

**Water:** +185°F (+85°C).

**Oil:** -40°F to +212°F.

(-40°C to +100°C).

**Fittings:** 82 Series - pg. B-178.

**WARNING:** This product can expose you to chemicals including Carbon Black, which is known to the State of California to cause cancer and DBP, which is known to the state of California to cause birth defect or other reproductive harm. For more information go to [www.p65warnings.ca.gov](http://www.p65warnings.ca.gov).

## 821FR Multipurpose – Fire-Resistant Cover

Available Cover Colors: **WHT** **BRN** **BLU** **GRN** **BLK**



[view on web page](#)

# Part Number	Hose I.D.		Hose O.D.		Working Pressure		Minimum Bend Radius		Weight		Vacuum Rating		Field Attachable 82 Series
	inch	mm	inch	mm	psi	MPa	inch	mm	lbs/ft	kg/m	inches of Hg	kPa	
821FR-4	1/4	6,3	0.50	12,7	350	2,4	2-1/2	64	0.08	0,12	28	95	●
821FR-6	3/8	10	0.63	15,9	300	2,1	3	76	0.11	0,16	28	95	●
821FR-8	1/2	12,5	0.78	19,8	300	2,1	5	127	0.12	0,18	28	95	●
821FR-12	3/4	19	1.03	26,2	250	1,7	7	178	0.22	0,33	28	95	●

**Application:** Pneumatic, petroleum base hydraulic fluid, lubricating oils and antifreeze solutions.

**Inner Tube:** PKR®.

**Reinforcement:** One fiber braid.

**Cover:** Fire resistant fiber braid.

**Hose cover colors include:** White, Brown, Blue, Green, and Black.

**Temperature Range:**

**Air:** +212°F (+100°C).

**Water:** +185°F (+85°C).

**Oil:** -40°F to +212°F (-40°C to +100°C).

**Fittings:** 82 Series - pg. B-178.

- Field Attachable Assembly Instructions are in Section B with each Fittings Series.
- Push-Lok is not recommended for any fuel, refrigerant, or for use in air conditioners and heat pump applications.
- Push-Lok is not recommended for applications where extreme pulsation is encountered.
- Temperature Range of other media listed in Section E.

**WARNING:** This product can expose you to chemicals including Carbon Black, which is known to the State of California to cause cancer. For more information go to [www.p65warnings.ca.gov](http://www.p65warnings.ca.gov).

A

# THERMAL COOLING 627

## Performance



Parker's 627 Thermal Cooling Hose is designed to be utilized for the transfer of coolant in high performance computers and data farms. The tube is specially compounded peroxide cured EPDM, which is formulated to be compatible with industrial coolants.



[view on web page](#)

B

## 627 Thermal Cooling

Available Cover Colors: **BLK**

# Part Number	Hose I.D.		Reinf Layers	Hose O.D.		Weight		Minimum Bend Radius		Working Pressure		Perm Cplg Rec	Nom Std Pack Qty	Pkg Type
	inch	mm		inch	mm	lbs/ft	kg/m	inch	mm	psi	bar			
627-6-RL	3/8	9.5	2	0.7	16.7	0.13	0.19	1.3	33	150	10	•	700	Reel
627-8-RL	1/2	12.7	4	0.9	22.7	0.24	0.36	2.0	51	150	10	•	550	Reel
627-12-RL	3/4	19.1	4	1.2	29.4	0.34	0.51	3.0	76	150	10	•	400	Reel
627-16-RL	1	25.4	4	1.4	36.3	0.46	0.68	4.5	114	150	10	•	300	Reel
627-20-RL	1 1/4	31.8	4	1.8	45.7	0.67	1.01	6.5	165	150	10	•	250	Reel
627-24-RL	1 1/2	38.1	4	2	50	0.84	1.24	9	228	150	10	•	200	Reel

**Application:** Thermal Cooling

**Tube:** Black EPDM, peroxide cured

**Reinforcement:** Multiple textile plies

**Cover:** Black EPDM; smooth finish

**Temperature Range:** -40°F to +212°F (-40°C to +100°C)

**Brand Method:** White ink

**Brand Example:** PARKER 627-16 EPDM-P WP 1MPa (150 PSI) 25,4mm (1") RU L94 HB Flame Resistance MADE IN USA

**Design Factor:** 4:1

**Industry Standards:** UL94 Flame Resistance Rating HB

**Vacuum:** Not Recommended

**Couplings:** Designed to be used with hose barbs and clamps

C

D

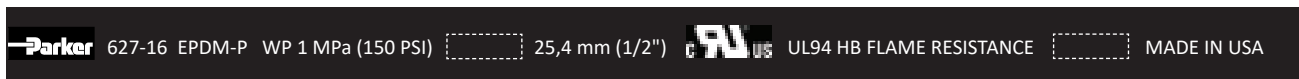

Manufacturer's Identification

Date Code

E

**WARNING:** This product can expose you to chemicals including Carbon Black, which is known to the State of California to cause cancer. For more information go to [www.p65warnings.ca.gov](http://www.p65warnings.ca.gov).

Updated 3/2022

# PHOSPHATE-ESTER 424, 304, 774, F42

## Markets



Parker's phosphate-ester hoses enables you to address the needs of the next generation aviation ground support equipment and the trend towards higher pressures in other industries using phosphate-ester fluids. Our hose selection offers the industry's largest selection of low-, medium-, and high-pressure hoses specifically designed to resist aggressive airline hydraulic fluids. Parker's phosphate-ester hose line, together with the proper EPDM O-ring face seal and 37° Flare fittings and pipe adapters, means your leak-free assemblies will be the last thing you'll need to worry about.

### 424 hose

- Up to 1,000 psi
- Dimensionally conforms to SAE 100R1 Type AT specification
- Uses Parkrimp 43 Series fittings, providing the widest selection of end configurations available anywhere

### 304 hose

- Up to 5,000 psi
- Dimensionally conforms to SAE 100R2 Type AT specification
- Uses Parkrimp 43 Series fittings, providing the widest selection of end configurations available anywhere

### 774 hose

- Up to 4,000 psi
- Dimensionally conforms to SAE 100R12 and EN 856 Type R12 specifications
- Uses Parkrimp 71 Series fittings

### F42 hose

- 6,000 psi maximum working pressure
- Compatible with phosphate ester based hydraulic fluids with a temperature range of -40°C to +80°C (-40°F to +176°F)
- Uses Parkrimp 70 / 79 Series fittings

## 424 Hydraulic – Phosphate-Ester Base Fluids



[view on web page](#)

# Part Number	Hose I.D.		Hose O.D.		Working Pressure		Minimum Bend Radius		Weight		Vacuum Rating		Parkrimp 43 Series
	inch	mm	inch	mm	psi	MPa	inch	mm	lbs/ft	kg/m	inches of Hg	kPa	
424-16	1	25	1.40	36	1000	6,9	12	300	0.63	0,94	20	68	●
424-20	1-1/4	31,5	1.73	44	625	4,3	16-1/2	420	0.80	1,19	20	68	●
424-24	1-1/2	38	2.00	51	500	3,5	20	500	1.00	1,49	15	51	●
424-32	2	51	2.50	64	375	2,6	25	630	1.50	2,23	11	37	●

**Application:** Phosphate-ester base hydraulic fluids.

**Inner Tube:** EPDM rubber.

**Reinforcement:** One-braid steel wire.

**Cover:** EPDM rubber, green.

**Temperature Range:** -40°F to +176°F (-40°C to +80°C).

**Fittings:** 43 Series - pg. B-27.

- See Section C for Parkrimp Assembly Instructions.
- Temperature Range of other media listed in Section E.

**WARNING:** This product can expose you to chemicals including Carbon Black, which is known to the State of California to cause cancer. For more information go to [www.p65warnings.ca.gov](http://www.p65warnings.ca.gov).

# PHOSPHATE-ESTER

## 304 Hydraulic – Phosphate-Ester Base Fluids



[view on web page](#)

# Part Number	Hose I.D.		Hose O.D.		Working Pressure		Minimum Bend Radius		Weight		Parkrimp 43 Series
	inch	mm	inch	mm	psi	MPa	inch	mm	lbs/ft	kg/m	
304-4	1/4	6,3	0.59	15	5000	34,5	4	100	0.26	0,39	●
304-6	3/8	10	0.75	19	4000	27,5	5	130	0.37	0,55	●
304-8	1/2	12,5	0.88	22	3500	24	7	180	0.45	0,67	●
304-10	5/8	16	1.00	25	2750	19	8	200	0.53	0,79	●
304-12	3/4	19	1.16	29	2250	15,5	9-1/2	240	0.67	1,00	●
304-16	1	25	1.50	38	2000	13,8	12	300	1.00	1,49	●
304-20	1-1/4	31,5	1.86	47	1625	11,2	16-1/2	420	1.16	1,73	●
304-24	1-1/2	38	2.14	54	1250	8,6	20	500	1.44	2,14	●
304-32	2	51	2.64	67	1125	7,8	25	630	1.99	2,96	●

**Application:** Phosphate-ester base hydraulic fluids.

**Inner Tube:** EPDM rubber.

**Reinforcement:** Two-braid steel wire.

**Cover:** EPDM rubber, green.

**Temperature Range:** -40°F to +176°F (-40°C to +80°C).

**Fittings:** 43 Series - pg. B-27.

**WARNING:** This product can expose you to chemicals including Carbon Black, which is known to the State of California to cause cancer. For more information go to [www.p65warnings.ca.gov](http://www.p65warnings.ca.gov).

## 774 Hydraulic – Phosphate-Ester Base Fluids



[view on web page](#)

# Part Number	Hose I.D.		Hose O.D.		Working Pressure		Minimum Bend Radius		Weight		Parkrimp 71 Series
	inch	mm	inch	mm	psi	MPa	inch	mm	lbs/ft	kg/m	
774-12	3/4	19	1.21	31	4000	28,0	9-1/2	240	0.94	1,40	●
774-16	1	25	1.50	38	4000	28,0	12	300	1.34	1,99	●
774-20	1-1/4	31,5	1.84	46	3000	21,0	16-1/2	420	1.74	2,59	●
774-24	1-1/2	38	2.07	53	2500	17,5	20	500	2.01	2,99	●
774-32	2	51	2.59	66	2500	17,5	25	630	2.75	4,09	●

**Application:** Phosphate-ester base hydraulic fluids.

**Inner Tube:** EPDM rubber.

**Reinforcement:** Four-spiral steel wire.

**Cover:** EPDM rubber, green.

**Temperature Range:** -40°F to +176°F (-40°C to +80°C).

**Fittings:** 71 Series - pg. B-75.

- See Section C for Parkrimp Assembly Instructions.
- Temperature Range of other media listed in Section E.

**WARNING:** This product can expose you to chemicals including Carbon Black, which is known to the State of California to cause cancer. For more information go to [www.p65warnings.ca.gov](http://www.p65warnings.ca.gov).

# PHOSPHATE-ESTER

## F42 Hydraulic – Phosphate-Ester Base Fluids



[view on web page](#)

# Part Number	Hose I.D.		Hose O.D.		Working Pressure		Minimum Bend Radius		Weight		Parkrimp 70 Series	Parkrimp 79 Series
	inch	mm	inch	mm	psi	MPa	inch	mm	lbs/ft	kg/m		
F42-8	1/2	12,5	0.97	25,0	6000	42,0	8	200	0.56	0,83	•	
F42-12	3/4	19	1.26	31,9	6000	42,0	10-1/2	265	1.03	1,53		•
F42-16	1	25	1.52	38,5	6000	42,0	13	330	1.40	2,08		•
F42-20	1-1/4	31,5	1.97	50	6000	42,0	17-1/2	445	2.66	3,96		•

**Application:** Phosphate-ester base hydraulic fluids.

**Inner Tube:** EPDM rubber.

**Reinforcement:** Four- or six-spiral steel wire.

**Cover:** EPDM rubber, green.

**Temperature Range:** -40°F to +176°F (-40°C to +80°C).

**Fittings:** 70 Series - pg. B-65.  
79 Series - pg. B-125.

- See Section C for Parkrimp Assembly Instructions.
- Temperature Range of other media listed in Section E.



**WARNING:** This product can expose you to chemicals including Carbon Black, which is known to the State of California to cause cancer. For more information go to [www.p65warnings.ca.gov](http://www.p65warnings.ca.gov).

LOW TEMP

# 472LT, 722LT, 792LT

## Markets



In extremely cold and usually remote areas, a hose burst or leak in a critical application can cause expensive downtime and possible environmental issues. Selecting the right hose for dependable, long-life performance in these applications is essential.

Parker's family of low-temperature hoses are designed specifically to excel in the brutal operating conditions of extreme cold!

- Delivers superior performance in extreme cold conditions
- Rated as low as -70°F (-57°C)
- The choice for heavy construction equipment, side booms, mining equipment, mobile equipment, arctic oil field, snow grooming equipment, snow making machinery and cold storage applications
- These No-Skive hoses use Parker's standard 43, 71, and 79 Series fittings and easy-to-use Parkrimp style crimping system



## Performance



### 472LT

Low-Temperature Braided  
EN 857 TYPE 2SC



[view on web page](#)

# Part Number	Hose I.D.		Hose O.D.		Working Pressure		Minimum Bend Radius		Weight		Parkrimp 43 Series
	inch	mm	inch	mm	psi	MPa	inch	mm	lbs/ft	kg/m	
472LT-4	1/4	6,3	0.53	13,1	5800	40,0	2	50	0.20	0,30	●
472LT-6	3/8	10	0.67	17,2	5000	35,0	2-1/2	65	0.24	0,42	●
472LT-8	1/2	12,5	0.71	20,4	4250	29,7	3-1/2	90	0.35	0,52	●
472LT-10	5/8	16	0.94	23,9	3625	25,0	4	100	0.44	0,66	●
472LT-12	3/4	19	1.09	27,7	3125	21,5	4-3/4	120	0.58	0,86	●
472LT-16	1	25	1.39	35,4	2500	17,5	6	150	0.79	1,17	●

**Application:** Petroleum base hydraulic fluids and lubricating oils in low-temperature conditions.

**Inner Tube:** Proprietary synthetic rubber compound.

**Reinforcement:** Two-braid high tensile steel wire.

**Cover:** Proprietary synthetic rubber compound.

**Temperature Range:** -70°F to +212°F (-57°C to +100°C).

**Fittings:** 43 Series, sizes -4 to -16 - pg. B-27.

- See Section C for Parkrimp Assembly Instructions.
- Temperature Range of other media listed in Section E.

**WARNING:** This product can expose you to chemicals including Carbon Black, which is known to the State of California to cause cancer. For more information go to [www.p65warnings.ca.gov](http://www.p65warnings.ca.gov).



[view on web page](#)

## Performance



## 722LT

### Low-Temperature Spiral

ISO 3862-1 TYPE R12 / SAE J517 100R12 / EN 856 TYPE R12\*

# Part Number	Hose I.D.		Hose O.D.		Working Pressure		Minimum Bend Radius		Weight		Parkrimp 43 Series	Parkrimp 71 Series
	inch	mm	inch	mm	psi	MPa	inch	mm	lbs/ft	kg/m		
722LT-6	3/8	10	0.78	19,8	4000	28,0	2-1/2	65	0.40	0,60	●	
722LT-8	1/2	12,5	0.89	22,6	4000	28,0	3-1/2	90	0.54	0,80	●	
722LT-10	5/8	16	1.04	26,4	4000	28,0	4	100	0.74	1,10	●	
722LT-12	3/4	19	1.21	30,6	4000	28,0	4-3/4	120	0.94	1,40	●	
722LT-16	1	25	1.49	37,7	4000	28,0	6	150	1.34	1,99	●	
722LT-20	1-1/4	31,4	1.82	46,2	3000	21,0	8-1/4	210	1.74	2,59	●	
722LT-24	1-1/2	38	2.06	52,5	2500	17,5	10	250	2.01	2,99		●

**Application:** Snow grooming equipment, heavy construction equipment and sidebooms.

**Inner Tube:** Nitrile synthetic rubber.

**Reinforcement:** Four-spiral steel wire.

**Cover:** Synthetic rubber, MSHA accepted.

**\*Temperature Range:** -70°F to +212°F (-57°C to +100°C).  
(Outside industry specification)

**Fittings:** 43 Series, sizes -6 to -20 - pg. B-27.  
71 Series, size -24 - pg. B-75.

**WARNING:** This product can expose you to chemicals including Carbon Black, which is known to the State of California to cause cancer. For more information go to [www.p65warnings.ca.gov](http://www.p65warnings.ca.gov).

## Performance



## 792LT

### Low-Temperature NO-SKIVE

ISO 3862-1 TYPE R15 / SAE J517 100R15 / EN 856 TYPE R15\*



[view on web page](#)

# Part Number	Hose I.D.		Hose O.D.		Working Pressure		Minimum Bend Radius		Weight		Parkrimp 79 Series
	inch	mm	inch	mm	psi	MPa	inch	mm	lbs/ft	kg/m	
792LT-16	1	25	1.52	38,7	6000	42,0	13	330	1.48	2,20	●
792LT-20	1-1/4	31,5	1.97	50	6000	42,0	17-1/2	445	2.48	3,69	●
792LT-24	1-1/2	38	2.22	57	6000	42,0	20-3/4	530	3.22	4,79	●

**Application:** Petroleum base hydraulic fluids and lubricating oils.

**Inner Tube:** Synthetic rubber.

**Reinforcement:** Four- or six-spiral wire, high tensile steel.

**Cover:** PKR Rubber.

**\*Temperature Range:** -70°F to +212°F (-57°C to +100°C).  
(Outside industry specification).

**Fittings:** 79 Series - pg. B-125.

- See Section C for Parkrimp Assembly Instructions.
- Temperature Range of other media listed in Section E.

**WARNING:** This product can expose you to chemicals including Carbon Black, which is known to the State of California to cause cancer. For more information go to [www.p65warnings.ca.gov](http://www.p65warnings.ca.gov).

# TRANSPORTATION 293, 213, 266

## Markets



Parker’s transportation hose selection has all your vehicle and equipment applications covered – with industry-leading performance and value you can count on. Meeting or exceeding specifications, Parker’s offerings are available in the sizes, pressure ratings, special designs and long-lasting durability your hydraulic or pneumatic systems demand.



[view on web page](#)

## Performance



### 293

#### Transportation – Air Brake Hose

SAE J1402 AI / DOT FMVSS 106 AIR BRAKE - AI

# Part Number	Hose I.D.		Hose O.D.		Working Pressure		Minimum Bend Radius		Weight		Vacuum Rating		Parkrimp	Field Attachable
	inch	mm	inch	mm	psi	MPa	inch	mm	lbs/ft	kg/m	inches of Hg	kPa	26 Series	21/23 Series
293-4	3/16	5	0.49	12,5	500	3,5	1/2	15	0.10	0,15	28	95	●	●
293-6	5/16	8	0.62	15,7	500	3,5	1	25	0.15	0,22	28	95	●	●
293-8	13/32	10	0.74	18,7	500	3,5	1-1/2	40	0.18	0,27	28	95	●	●
293-10	1/2	12,5	0.83	21,1	450	3,1	2	50	0.20	0,30	28	95	●	●
293-12	5/8	16	0.96	24,3	450	3,1	2-1/2	65	0.22	0,33	28	95	●	●
293-16	7/8	22	1.21	30,6	450	3,1	3-1/4	80	0.25	0,37	20	68	●	●

**Application:** Petroleum base hydraulic fluids and lubricating oils, diesel fuels, and antifreeze solutions.

**Inner Tube:** PKR®.

**Reinforcement:** One fiber braid.

**Cover:** Abrasion resistant nylon fiber braid.

**Temperature Range:** -58°F to +302°F (-50°C to +150°C).  
 Rated to 302°F, 150°C in engine applications  
 Rated to 212°F, 100°C in air brake applications

**Fittings:** 26 Series - pg. B-9.  
 21 Series - pg. B-155.

- Field Attachable Assembly Instructions are in Section B with each Fittings Series.
- See Section C for Parkrimp Assembly Instructions.
- Temperature Range of other media listed in Section E.
- SAE spec certification for 293 hose is for -4 through -12 only.

**WARNING:** This product can expose you to chemicals including Carbon Black, which is known to the State of California to cause cancer. For more information go to [www.p65warnings.ca.gov](http://www.p65warnings.ca.gov).



# TRANSPORTATION

## Markets



## Performance



## 213

### Transportation

SAE J1402 AI / DOT FMVSS 106 AIR BRAKE - AI



[view on web page](#)

# Part Number	Hose I.D.		Hose O.D.		Working Pressure		Minimum Bend Radius		Weight		Vacuum Rating		Parkrimp	Field Attachable
	inch	mm	inch	mm	psi	MPa	inch	mm	lbs/ft	kg/m	of Hg	kPa	26 Series	21/23 Series
213-4	3/16	5	0.49	12,5	2000	14	3/4	20	0.12	0,18	28	95	•	•
213-5	1/4	6,3	0.55	14	1500	10,5	1	25	0.14	0,21	28	95	•	•
213-6	5/16	8	0.62	16	1500	10,5	1-1/4	30	0.17	0,25	28	95	•	•
213-8	13/32	10	0.74	19	1250	8,7	1-3/4	45	0.20	0,30	28	95	•	•
213-10	1/2	12,5	0.83	21	1000	7	2-1/4	55	0.22	0,33	28	95	•	•
213-12	5/8	16	0.96	24	750	5,2	2-3/4	70	0.24	0,36	28	95	•	•
213-16	7/8	22	1.21	31	400	2,8	3-1/2	90	0.30	0,45	20	68	•	•
213-20	1-1/8	29	1.49	38	300	2,1	4-1/2	115	0.44	0,65	20	68	•	•
213-24	1-3/8	35	1.73	44	300	2,1	7-1/2	190	0.52	0,77	15	51	•	•
213-32	1-13/16	46	2.14	54	200	1,4	14	355	0.67	1,00	11	37	•	•
213-40*	2-3/8	61	2.88	73	175	1,2	24	610	1.31	1,95	11	64	•	•

\*NOTE: Due to fitting size, this is a factory crimp only.

**Application:** Petroleum base hydraulic fluids and lubricating oils, diesel fuels, and antifreeze solutions.

**Inner Tube:** PKR®.

**Reinforcement:** One fiber braid and one steel braid.

**Cover:** Fiber braid.

**Temperature Range:** -50°F to +302°F (-45°C to +150°C).  
 Rated to 302°F, 150°C in engine applications  
 Rated to 212°F, 100°C in air brake applications

**Fittings:** 26 Series - pg. B-9.  
 21 Series - pg. B-155.

- See page E-5 for charted effects temperature has on maximum working pressures of 201, 206, 213, and 266 hose.
- See Section B for Field Attachable Assembly Instructions.
- See Section C for Parkrimp Assembly Instructions.
- Temperature Range of other media listed in Section E.
- SAE spec certification for 213 hose is for -4 through -12 only.



**WARNING:** This product can expose you to chemicals including Carbon Black, which is known to the State of California to cause cancer. For more information go to [www.p65warnings.ca.gov](http://www.p65warnings.ca.gov).

Updated 9/2021

# TRANSPORTATION

A

## Markets



## Performance



B

C

D

E

## 266

### Transportation

SAE J1402 AII / DOT FMVSS 106 AIR BRAKE - All



[view on web page](#)

# Part Number	Hose I.D.		Hose O.D.		Working Pressure		Minimum Bend Radius		Weight		Vacuum Rating		Field Attachable	
	inch	mm	inch	mm	psi	MPa	inch	mm	lbs/ft	kg/m	inches of Hg	kPa	26 Series	20/22 Series
266-4	3/16	5	0.52	13,2	2000	14	3/4	20	0.15	0,22	28	95	●	●
266-5	1/4	6,3	0.58	14,8	1500	10,5	1	25	0.16	0,24	28	95	●	●
266-6	5/16	8	0.68	17,2	1500	10,5	1-1/4	30	0.23	0,34	28	95	●	●
266-8	13/32	10	0.77	19,5	1250	8,7	1-3/4	45	0.26	0,39	28	95	●	●
266-10	1/2	12,5	0.92	23,4	1250	8,7	2-1/4	55	0.38	0,56	28	95	●	●
266-12	5/8	16	1.08	27,4	750	5,2	2-3/4	70	0.42	0,63	20	68	●	●
266-16	7/8	22	1.24	31,4	400	2,8	3-1/2	90	0.48	0,71	15	51	●	●
266-20	1-1/8	29	1.50	38,4	300	2,1	4-1/2	115	0.51	0,76	15	51	●	●
266-24	1-3/8	35	1.75	44,5	250	1,7	5-1/2	140	0.68	1,01	11	37	●	●

**Application:** Petroleum base hydraulic fluids and lubricating oils, diesel fuels, and antifreeze solutions.

**Inner Tube:** PKR®.

**Reinforcement:** One fiber braid and one steel braid.

**Cover:** Fiber braid.

**Temperature Range:** -55°F to +302°F (-48°C to +150°C).  
 Rated to 302°F, 150°C in engine applications  
 Rated to 212°F, 100°C in air brake applications

**Fittings:** 26 Series - pg. 9.  
 20 Series - pg. B-145.  
 22 Series - pg. B-163.

- See page E-5 for charted effects temperature has on maximum working pressures of 201, 206, 213, and 266 hose.
- See Section B for Field Attachable Assembly Instructions.
- See Section C for Parkrimp Assembly Instructions.
- Temperature Range of other media listed in Section E.
- SAE spec certification for 266 hose is for -4 through -12 only.

**WARNING:** This product can expose you to chemicals including Carbon Black, which is known to the State of California to cause cancer. For more information go to [www.p65warnings.ca.gov](http://www.p65warnings.ca.gov).

# TRANSPORTATION 201, 206

## Markets



## Performance



## 201

### Transportation

SAE J517 100R5 / SAE J1402 AII / DOT FMVSS 106 AIR BRAKE - AII



[view on web page](#)

# Part Number	Hose I.D.		Hose O.D.		Working Pressure		Minimum Bend Radius		Weight		Vacuum Rating		Field Attachable	
	inch	mm	inch	mm	psi	MPa	inch	mm	lbs/ft	kg/m	of Hg	kPa	26 Series	20/22 Series
201-4	3/16	5	0.52	13	3000	21	3	75	0.15	0,22	28	95	●	●
201-5	1/4	6,3	0.58	15	3000	21	3-3/8	85	0.18	0,27	28	95	●	●
201-6	5/16	8	0.68	17	2250	15,7	4	100	0.23	0,34	28	95	●	●
201-8	13/32	10	0.77	20	2000	14	4-1/2	115	0.27	0,40	28	95	●	●
201-10	1/2	12,5	0.92	23	1750	12,2	5-1/2	140	0.37	0,55	28	95	●	●
201-12	5/8	16	1.08	27	1500	10,5	6-1/2	165	0.40	0,60	28	95	●	●
201-16	7/8	22	1.23	31	800	5,6	7-3/8	185	0.46	0,68	20	68	●	●
201-20	1-1/8	29	1.50	38	625	4,3	9	230	0.51	0,76	20	68	●	●
201-24	1-3/8	35	1.75	44	500	3,5	10-1/2	265	0.68	1,01	15	51	●	●
201-32	1-13/16	46	2.22	56	350	2,4	13-1/4	335	0.89	1,32	11	37	●	●
201-40	2-3/8	60	2.88	73	350	2,4	24	610	1.31	1,95	11	37	●	●
201-48	3	76	3.56	90	200	1,4	33	840	2.09	3,11	11	37	●	●

**Application:** Petroleum base hydraulic fluids and lubricating oils, diesel fuels, and antifreeze solutions.

**Inner Tube:** Synthetic rubber.

**Reinforcement:** One fiber braid and one steel braid.

**Cover:** Fiber braid.

**Temperature Range:** -40°F to +302°F (-40°C to +150°C).  
 Rated to 302°F, 150°C in engine applications  
 Rated to 212°F, 100°C in air brake applications

**Fittings:** 26 Series - pg. B-9.  
 20 Series - pg. B-145.  
 22 Series - pg. B-163.

- See page E-5 for charted effects temperature has on maximum working pressures of 201, 206, 213, and 266 hose.
- See Section B for Field Attachable Assembly Instructions.
- See Section C for Parkrimp Assembly Instructions.
- Temperature Range of other media listed in Section E.
- SAE spec certification for 201 hose is for -4 through -12 only.



**WARNING:** This product can expose you to chemicals including Carbon Black, which is known to the State of California to cause cancer. For more information go to [www.p65warnings.ca.gov](http://www.p65warnings.ca.gov).

# TRANSPORTATION



view on web page

## 206

### Transportation

SAE J517 100R5 / SAE J1402 AII / DOT FMVSS 106 AIR BRAKE - AII

### Markets



### Performance



# Part Number	Hose I.D.		Hose O.D.		Working Pressure		Minimum Bend Radius		Weight		Vacuum Rating		Parkrimp	Field Attachable
	inch	mm	inch	mm	psi	MPa	inch	mm	lbs/ft	kg/m	inches of Hg	kPa	26 Series	20/22 Series
206-4	3/16	5	0.52	13	3000	21	3	75	0.15	0,22	28	95	●	●
206-5	1/4	6,3	0.58	15	3000	21	3-3/8	85	0.18	0,27	28	95	●	●
206-6	5/16	8	0.68	17	2250	15,7	3-1/2	90	0.23	0,34	28	95	●	●
206-8	13/32	10	0.77	20	2000	14	3-1/2	90	0.27	0,40	28	95	●	●
206-10	1/2	12,5	0.92	23	1750	12,2	4	100	0.37	0,55	28	95	●	●
206-12	5/8	16	1.08	27	1500	10,5	4	100	0.40	0,60	28	95	●	●
206-16	7/8	22	1.23	31	800	5,6	4	100	0.46	0,68	20	68	●	●
206-20	1-1/8	29	1.50	38	625	4,3	5-1/2	140	0.51	0,76	20	68	●	●
206-24	1-3/8	35	1.75	44	500	3,5	7-1/2	190	0.68	1,01	15	51	●	●
206-32	1-13/16	46	2.22	56	350	2,4	13-1/4	335	0.89	1,32	11	37	●	●
206-40	2-3/8	60	2.88	73	350	2,4	24	610	1.31	1,95	11	37	●	●

**Application:** Petroleum base hydraulic fluids and lubricating oils, diesel fuels, and antifreeze solutions.

**Inner Tube:** PKR®.

**Reinforcement:** One fiber braid and one steel braid.

**Cover:** Fiber braid, blue.

**Temperature Range:** -55°F to +302°F (-48°C to +150°C).  
 Rated to 302°F, 150°C in engine applications  
 Rated to 212°F, 100°C in air brake applications

**Fittings:** 26 Series - pg. B-9.  
 20 Series - pg. B-145.  
 22 Series - pg. B-163.

- See page E-5 for charted effects temperature has on maximum working pressures of 201, 206, 213, and 266 hose.
- See Section B for Field Attachable Assembly Instructions.
- See Section C for Parkrimp Assembly Instructions.
- Temperature Range of other media listed in Section E.
- SAE spec certification for 206 hose is for -4 through -12 only.

**WARNING:** This product can expose you to chemicals including Carbon Black, which is known to the State of California to cause cancer. For more information go to [www.p65warnings.ca.gov](http://www.p65warnings.ca.gov).

Updated 9/2021

# TRANSPORTATION 611HT



view on web page

## Markets



## Performance



## 611HT

### Transportation

SAE J517 100R6 / EN 854 TYPE R6

# Part Number	Hose I.D.		Hose O.D.		Working Pressure		Minimum Bend Radius		Weight		Vacuum Rating		Parkrimp HY Series
	inch	mm	inch	mm	psi	MPa	inch	mm	lbs/ft	kg/m	inches of Hg	kPa	
611HT-4	1/4	6,2	0.47	11,9	400	2,8	2 1/2	65	0.09	0,13	28	95	●
611HT-6	3/8	9,3	0.59	15,1	400	2,8	3	75	0.11	0,16	28	95	●
611HT-8	1/2	12,5	0.75	19,0	400	2,8	4	100	0.18	0,27	28	95	●
611HT-10	5/8	15,7	0.88	22,2	350	2,4	5	125	0.19	0,28	18	61	●
611HT-12	3/4	18,8	1.00	25,4	300	2,1	6	150	0.25	0,36	18	61	●

**Application:** Petroleum base hydraulic fluids and lubricating oils, diesel fuels, and antifreeze solutions.

**Inner Tube:** PKR®.

**Reinforcement:** One fiber braid.

**Cover:** Synthetic rubber abrasion resistant, MSHA accepted.

**Temperature Range:** -55°F to +302°F (-48°C to +150°C).

**Fittings:** HY Series - pg. B-130.

- See Section C for Parkrimp Assembly Instructions.
- Temperature Range of other media listed in Section E.
- 611HT hose is not approved with any HY Series stainless steel fittings.

**WARNING:** This product can expose you to chemicals including Carbon Black, which is known to the State of California to cause cancer. For more information go to [www.p65warnings.ca.gov](http://www.p65warnings.ca.gov).

# TRANSPORTATION 271 Air Brake



[view on web page](#)

## Markets



## 271

### Transportation – Air Brake Hose

SAE J1402 A / DOT FMVSS 106 AIR BRAKE - A

# Part Number	Hose I.D.		Hose O.D.		Working Pressure		Minimum Bend Radius		Weight		Parkrimp 25 Series
	inch	mm	inch	mm	psi	MPa	inch	mm	lbs/ft	kg/m	
271-6	3/8	10	0.75	19	225	1,6	1-3/4	45	0.20	0,30	•
271-8	1/2	12,5	0.88	22	225	1,6	2	50	0.26	0,39	•

**Application:** Air brake systems.

**Inner Tube:** Synthetic rubber.

**Reinforcement:** One or more fiber braid.

**Cover:** Synthetic Rubber.

**Temperature Range:** -50°F to +212°F (-46°C to +100°C).

**Fittings:** 25 Series - pg. B-5.

- See page E-5 for charted effects temperature has on maximum working pressures of 201, 206, 213, and 266 hose.
- See Section C for Parkrimp Assembly Instructions.
- Temperature Range of other media listed in Section E.

**⚠ WARNING:** This product can expose you to chemicals including Carbon Black, which is known to the State of California to cause cancer. For more information go to [www.p65warnings.ca.gov](http://www.p65warnings.ca.gov).

# ALTERNATIVE / MARINE

## SS23CG

### Markets



If you make or maintain LPG / CNG powered equipment, SS23CG hose is your choice for gas permeation resistance and reliable performance. SS23CG meets the requirements of CSA 8.1-2015 Type III and meets permeation requirements of 1,6 g/m<sup>2</sup>-day. Hose assemblies should be installed in accordance with CSA B149.1.



### SS23CG

Transportation – Compressed Natural Gas and Liquefied Petroleum Gas

UL 21 / CSA 8.1 2015 TYPE III / NFPA 58



[view on web page](#)

# Part Number	Hose I.D.		Hose O.D.		Working Pressure		Minimum Bend Radius		Weight		Parkrimp 26 Series
	inch	mm	inch	mm	psi	MPa	inch	mm	lbs/ft	kg/m	
SS23CG-6	5/16	8,0	0.68	17,2	350	2,4	4	100	0.16	0,24	●
SS23CG-8	13/32	10,0	0.77	19,5	350	2,4	4-1/2	115	0.17	0,25	●
SS23CG-10	1/2	12,5	0.92	23,4	350	2,4	5-1/2	140	0.28	0,42	●
SS23CG-12	5/8	15,9	1.05	26,8	350	2,4	6-1/2	165	0.30	0,45	●

FACTORY MADE HOSE ASSEMBLIES ONLY. Contact Hose Products Division for more information. For ECE R110 and ECE R67 approval, contact Hose Products Division.

**Application:** Liquefied petroleum gas (LPG), Compressed natural gas (CNG).

**Inner Tube:** Nylon.

**Reinforcement:** One stainless steel braid.

**Cover:** Synthetic rubber.

**Temperature Range:** -40°F to +250°F (-40°C to +121°C).

**Fittings:** 26 Series - pg. B-9.

- Embossed layline per industry standard
- See Section C for Parkrimp Assembly Instructions.
- Temperature Range of other media listed in Section E.

**WARNING:** This product can expose you to chemicals including Carbon Black, which is known to the State of California to cause cancer. For more information go to [www.p65warnings.ca.gov](http://www.p65warnings.ca.gov).



# ALTERNATIVE / MARINE

## SS25UL

### Markets



- Low-pressure service with liquefied petroleum gas
- UL Standard 21 certification
- Oil and LPG resistant synthetic fiber cover
- Compatible with 26 Series Parkrimp style fittings

### SS25UL

#### Transportation – Liquefied Petroleum Gas

UL 21 / NFPA 58



[view on web page](#)

# Part Number	Hose I.D.		Hose O.D.		Working Pressure		Minimum Bend Radius		Weight		Parkrimp 26 Series	Field Attachable 20/22 Series
	inch	mm	inch	mm	psi	MPa	inch	mm	lbs/ft	kg/m		
SS25UL-4	3/16	5	0.52	13,2	350	2,4	0.75	20	0.11	0,16	•	•
SS25UL-5	1/4	6,3	0.58	14,8	350	2,4	1	25	0.13	0,19	•	•
SS25UL-6	5/16	8	0.68	17,2	350	2,4	1-1/4	30	0.18	0,27	•	•
SS25UL-8	13/32	10	0.77	19,5	350	2,4	1-3/4	45	0.21	0,31	•	•
SS25UL-10	1/2	12,5	0.92	23,4	350	2,4	2-1/4	55	0.29	0,43	•	•
SS25UL-12	5/8	16	1.08	27,4	350	2,4	2-3/4	70	0.37	0,55	•	•

**Application:** Liquefied petroleum gas (LPG).

**Inner Tube:** Synthetic rubber.

**Reinforcement:** One fiber braid and one stainless steel wire braid.

**Cover:** Fiber braid.

**Temperature Range:** -40°F to +250°F (-40°C to +121°C).

**Fittings:** 26 Series - pg. B-9.  
20 Series - pg. B-145.  
22 Series - pg. B-163.

**WARNING:** This product can expose you to chemicals including Carbon Black, which is known to the State of California to cause cancer. For more information go to [www.p65warnings.ca.gov](http://www.p65warnings.ca.gov).

### SS25UL-AGA

#### Transportation – Liquefied Petroleum Gas

AS / NZS 1869-2012 CLASS D



[view on web page](#)

# Part Number	Hose I.D.		Hose O.D.		Working Pressure		Minimum Bend Radius		Weight		Parkrimp 26 Series	Field Attachable 20/22 Series
	inch	mm	inch	mm	psi	MPa	inch	mm	lbs/ft	kg/m		
SS25UL-4-AGA	3/16	5	0.52	13,2	375	2,6	0.75	20	0.11	0,16	•	•
SS25UL-6-AGA	5/16	8	0.68	17,2	375	2,6	1-1/4	30	0.18	0,27	•	•
SS25UL-8-AGA	13/32	10	0.77	19,5	375	2,6	1-3/4	45	0.21	0,31	•	•

FACTORY MADE HOSE ASSEMBLIES ONLY. Contact Hose Products Division for more information.

**Application:** Liquefied petroleum gas (LPG).

**Inner Tube:** Synthetic rubber.

**Reinforcement:** One fiber braid and one stainless steel wire braid.

**Cover:** Fiber braid.

**Temperature Range:** -40°F to +250°F (-40°C to +121°C).

**Fittings:** 26 Series - pg. B-9.  
20 Series - pg. B-145.  
22 Series - pg. B-163.

- See Section B for Field Attachable Assembly Instructions.
- See Section C for Parkrimp Assembly Instructions.
- Temperature Range of other media listed in Section E.

**WARNING:** This product can expose you to chemicals including Carbon Black, which is known to the State of California to cause cancer. For more information go to [www.p65warnings.ca.gov](http://www.p65warnings.ca.gov).



# ALTERNATIVE / MARINE

# 221FR

## Markets



Parker's 221FR hose is a transportation hose used for marine fuel and engines that provides fire resistance for gasoline and fuel systems. The 221FR hose is manufactured to meet many industry standards, such as ISO and SAE, for reliability.

- ISO 7840 and USCG approved
- Marine fuel and engine hose



## 221FR

Transportation – Marine Fuel and Engine Hose  
ISO 7840 / SAE J1527 A CLASS I / SAE J1942

[view on web page](#)

# Part Number	Hose I.D.		Hose O.D.		Working Pressure		Minimum Bend Radius		Weight		Vacuum Rating		Field Attachable	
	inch	mm	inch	mm	psi	MPa	inch	mm	lbs/ft	kg/m	inches of Hg	kPa	26 Series	20/22 Series
221FR-5	1/4	6,3	0.58	15	500	3,5	1	25	0.19	0,28	24	81	•	•
221FR-6	5/16	8	0.68	17	500	3,5	1-1/4	30	0.23	0,34	24	81	•	•
221FR-8	13/32	10	0.77	20	500	3,5	1-3/4	45	0.28	0,42	24	81	•	•
221FR-10	1/2	12,5	0.92	23	500	3,5	2-1/4	55	0.39	0,58	20	68	•	•
221FR-12	5/8	16	1.08	27	500	3,5	2-3/4	70	0.41	0,61	20	68	•	•
221FR-16	7/8	22	1.23	31	500	3,5	3-1/2	90	0.47	0,70	20	68	•	•

ISO 7840 with 26 Series fittings ONLY.

**Application:** Gasoline, ethanol blends, diesel fuels, petroleum base hydraulic fluid, and lubricating oils.

**Inner Tube:** Synthetic rubber.

**Reinforcement:** One-braid steel wire.

**Cover:** Synthetic rubber, blue, MSHA accepted.

**Temperature Range:** -4°F to +212°F (-20°C to +100°C).

**Fittings:** 26 Series - pg. B-9.  
20 Series - pg. B-145.  
22 Series - pg. B-163.

- See Section B for Field Attachable Assembly Instructions.
- See Section C for Parkrimp Assembly Instructions.
- Temperature Range of other media listed in Section E.

**WARNING:** This product can expose you to chemicals including Carbon Black, which is known to the State of California to cause cancer. For more information go to [www.p65warnings.ca.gov](http://www.p65warnings.ca.gov).

# REFRIGERANT 285 Barrier Air Conditioning Hose

## Markets



Parker 285 Barrier Hose is designed to deliver consistency and reliability with a pressure range of 350-500 psi for air conditioning systems.

Parker 285 Hose exceeds current industry standards for ultra-low refrigerant permeation and is designed, built, and tested to meet SAE J3062 Type C<sub>U</sub> performance specifications. The hose is designed to meet Automotive OEM requirements for R134a and the next generation R1234yf refrigerants.

- Highly flexible
- Exceeds Automotive OEM requirements
- Exceeds SAE J3062 “Ultra Low” refrigerant permeation rating (1.5 kg/m<sup>2</sup>/yr R134a)
- Compatible with Parker’s 26 series fittings



[view on web page](#)

## 285 Refrigerant SAE J3062 TYPE C<sub>U</sub>

# Part Number	Hose I.D.		Hose O.D.		Working Pressure		Minimum Bend Radius		Weight		Vacuum Rating		Parkrimp 26 Series
	inch	mm	inch	mm	psi	MPa	inch	mm	lbs/ft	kg/m	inches of Hg	kPa	
285-4	3/16	5,08	0.490	12,45	500	3,4	1	25	0.09	0,13	28	95	●
285-6	5/16	8,23	0.580	14,73	500	3,4	1-1/2	40	0.10	0,14	28	95	●
285-8	13/32	10,67	0.680	17,27	500	3,4	2	50	0.13	0,17	28	95	●
285-10	1/2	12,95	0.765	19,43	500	3,4	2-1/2	65	0.15	0,19	28	95	●
285-12	5/8	16,13	1.000	25,4	500	3,4	3	75	0.19	0,27	28	95	●
285-14	3/4	19,05	1.080	27,4	350	2,4	3-1/2	89	0.24	0,34	28	95	●

**Application:** Refrigerants R134a / PAG Oil & R1234yf / PAG Oil.

**Inner Tube:** Synthetic rubber with nylon barrier.

**Reinforcement:** Synthetic fiber.

**Cover:** Synthetic rubber.

**Temperature Range:** -40°F to +257°F (-40°C to +125°C).

**Fittings:** 26 Series - pg. B-9.

- See Section C for Parkrimp Assembly Instructions.
- Temperature Range of other media listed in Section E.

**WARNING:** This product can expose you to chemicals including ethylene thiourea, which is known to the State of California to cause cancer and birth defect or other reproductive harm. For more information go to [www.p65warnings.ca.gov](http://www.p65warnings.ca.gov).

# REFRIGERANT 244

## Markets



Parker's 244 hose is a one braid steel wire refrigerant hose that has a pressure range of 350 to 500 psi, designed for the rigorous requirements of bus and transit applications.

- Air conditioning hose
- Excellent effusion rate
- Long service life
- Resists moisture ingress
- Parkrimp compatible

## 244 Refrigerant SAE J2064 B CLASS I



[view on web page](#)

# Part Number	Hose I.D.		Hose O.D.		Working Pressure		Minimum Bend Radius		Weight		Vacuum Rating		Parkrimp 26 Series
	inch	mm	inch	mm	psi	MPa	inch	mm	lbs/ft	kg/m	inches of Hg	kPa	
244-16	7/8	22	1.23	31	500	3,5	7-1/2	190	0.51	0,76	28	95	●
244-20	1-1/8	29	1.50	38	500	3,5	9	230	0.56	0,83	28	95	●
244-24	1-3/8	35	1.75	44	350	2,4	10-1/2	270	0.62	0,92	28	95	●

**Application:** Refrigerant 134a.

**Inner Tube:** Butyl rubber.

**Reinforcement:** One-braid steel wire.

**Cover:** Fiber braid.

**Temperature Range:** -22°F to +257°F (-30°C to +125°C).

**Fittings:** 26 Series - pg. B-9.

- See Section B for Field Attachable Assembly Instructions.
- See Section C for Parkrimp Assembly Instructions.
- Temperature Range of other media listed in Section E.

**WARNING:** This product can expose you to chemicals including Carbon Black, which is known to the State of California to cause cancer. For more information go to [www.p65warnings.ca.gov](http://www.p65warnings.ca.gov).



# Fittings

Parkrimp (Crimp) Series    Field Attachable Series

**Parkrimp (crimp) Series of Fittings**

**A**

25 Series ..... B-5

26 Series ..... B-9

43 Series ..... B-27

70 Series ..... B-65

71 Series ..... B-75

77 Series ..... B-90

79 Series ..... B-125

HY Series ..... B-130

81 Series ..... B-193

**Field Attachable Series of Fittings**

**B**

**C**

20 Series ..... B-145

21 Series ..... B-155

22 Series ..... B-163

30 Series ..... B-167

42 Series ..... B-173

82 Series ..... B-178

88 Series ..... B-193

**D**

**E**

## How to Read the Fittings Section

With more than 750 end configurations, Parker's brass, stainless steel and Chromium-6 free plated steel fittings include O-ring face seal, flare, straight thread, pipe and metric designs, in both crimp and field attachable styles. Along with Parker hose, all fittings have been tested and approved, and meet stringent industry standards worldwide. Fitting page content is defined by the information shown below. Please take a moment and review.

### How to Select Parkrimp Hose Fittings

Example: 1JC43-12-8C

- 1**JC43-12-8C - Fitting (1=Crimp, 2=Field attachable, 3=Push-Lok, Blank=Nipple with clamp)
- JC**43-12-8C - End Connection
- 1JC**43-12-8C - Fitting Series
- 1JC43-12**-8C - Size of Fitting End Connection
- 1JC43-12-8**C - Hose Size
- 1JC43-12-8C** - Fitting Material
  - No Suffix = Steel
  - B = Brass
  - C = 316 Stainless Steel
  - BA = Brass Nipple with Steel Nut and Socket
  - BS = Brass Nipple and Nut with Steel Shell or Socket
  - SM = Metric Index
  - ZJ = XTR Coating

**Hose Inner Diameter**  
Measured in 1/16 inch increments identified by use of a "dash"(-) numbering system. i.e., 4/16" = 1/4" = -4.

**"A" Dimension**  
Overall Length

**Hex size**  
Use to determine the wrench size

**"B" Dimension**  
(Cutoff Allowance) Dimension used to determine cut length (C.L.) of hose when making a hose assembly

**Fitting Information**  
Base part number and end connection description

Catalog 4400 US      43 Series Fittings

**Use with hoses:** 302, 304, 351ST, 351TC, 387TC/ST, 422, 424, 426, 431, 436, 451TC, 451ST, 471TC, 471ST, 472TC, 482TC, 482ST, 487TC/ST, 722TC, 787TC/ST, 797TC/ST, 881

Lists approved hoses for fitting series

Standard material for fittings is steel. For additional material, refer to column

**1JC43**  
Female Seal-Lok® - Swivel - Short  
ISO 12151-1 - SWSA

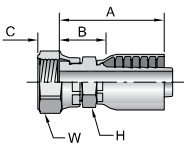

# Part Number	Thread inch	Hose I.D. inch	A		C		H		W		B	Additional Material Stainless Steel (C)
			inch	mm	inch	mm	inch	mm	inch	mm		
1JC43-4-4	1/4	9/16x18	1/4	1.63	41	0.32	8	9/16	11/16	0.88	22	•
1JC43-4-4-SM	1/4	9/16x18	1/4	1.63	41	0.32	8	17 mm	17 mm	0.88	22	
1JC43-4-6	1/4	9/16x18	3/8	1.90	48	0.32	8	11/16	11/16	0.87	22	
1JC43-6-4	3/8	11/16x16	1/4	1.67	42	0.32	8	11/16	13/16	0.92	23	
1JC43-6-4-SM	3/8	11/16x16	1/4	1.67	42	0.32	8	17 mm	22 mm	0.92	23	
1JC43-6-5	3/8	11/16x16	5/16	1.65	42	0.32	8	11/16	13/16	0.90	23	
1JC43-6-6	3/8	11/16x16	3/8	1.94	49	0.32	8	11/16	13/16	0.91	23	•
1JC43-6-6-SM	3/8	11/16x16	3/8	1.94	49	0.32	8	19 mm	22 mm	0.91	23	
1JC43-8-6	1/2	13/16x16	3/8	2.00	51	0.43	11	13/16	15/16	0.97	25	
1JC43-8-6-SM	1/2	13/16x16	3/8	2.00	51	0.43	11	19 mm	24 mm	0.97	25	
1JC43-8-8	1/2	13/16x16	1/2	2.22	56	0.43	11	13/16	15/16	0.96	24	•
1JC43-8-8-SM	1/2	13/16x16	1/2	2.22	56	0.43	11	22 mm	24 mm	0.96	24	
1JC43-10-8	5/8	1x14	1/2	2.30	58	0.53	13	15/16	1-1/8	1.04	26	
1JC43-10-8-SM	5/8	1x14	1/2	2.30	58	0.53	13	24 mm	30 mm	1.04	26	
1JC43-10-10	5/8	1x14	5/8	2.49	63	0.53	13	15/16	1-1/8	1.05	27	•
1JC43-10-10-SM	5/8	1x14	5/8	2.49	63	0.53	13	24 mm	30 mm	1.05	27	
1JC43-12-8	3/4	1-3/16x12	1/2	2.48	63	0.57	14	1-1/8	1-3/8	1.22	31	

Indicates Fitting Section

Continued on next page

# How to select hose fittings

To make ordering Parker products easier, we have outlined the nomenclature for hose and fittings on this page. For information on ordering hose assemblies, see Section A.

## How to Select Hose

Example: 487TC-4

- 487TC-4 - Hose type
- 487TC-4 - Indicates the special feature of the hose (in this case, "Tough Cover")
- 487TC-4 - Hose inside diameter dash size (in this case, 4/16" or 1/4")

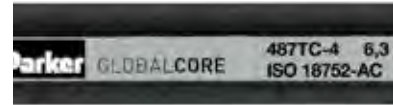

## How to Select Parkrimp Hose Fittings

Example: 1JC43-12-8C

- 1JC43-12-8C - Fitting (1 = Crimp, 2 = Field Attachable, 3 = Push-Lok, Blank = Nipple with clamp or shell)
- 1JC43-12-8C - End connection (In this case, a female Seal-Lok – swivel – straight)
- 1JC43-12-8C - Fitting series
- 1JC43-12-8C - Size of fitting end connection (In this case, 12/16" or 3/4")
- 1JC43-12-8C - Hose size (In this case, 8/16" or 1/2")
- 1JC43-12-8C - Fitting material:
  - No Suffix = Steel
  - B = Brass
  - C = 316 Stainless Steel
  - BA = Brass Nipple with Steel Nut and Socket
  - BS = Brass Nipple with Brass Nut and Socket
  - SM = Metric Hex



## How to Select Two-Piece Field Attachable Fittings

When selecting a two-piece field attachable fitting, the fitting part number (found in Section B of this catalog) needs to be broken down into two distinct numbers for the nipple and the socket.

Example: 20120-16-16B

### Socket Part Number

Example: 20020-16B

- 20020-16B - Fitting (1 = Crimp, 2 = Field Attachable, 3 = Push-Lok, Blank = Nipple with clamp or shell)
- 20020-16B - End connection ("00" represents that it is a socket)
- 20020-16B - Fitting series
- 20020-16B - Hose size (In this case, 16/16" or 1")
- 20020-16B - Fitting material:
  - No Suffix = Steel
  - B = Brass
  - C = 316 Stainless Steel
  - BA = Brass Nipple with Steel Nut and Socket
  - BS = Brass Nipple with Brass Nut and Socket
  - SM = Metric Hex



### Nipple Part Number

Example: 0120-16-16B

- \_0120-16-16B - Fitting (1 = Crimp, 2 = Field Attachable, 3 = Push-Lok, Blank = Nipple with clamp or shell)
- 0120-16-16B - End connection (In this case, a male NPTF Pipe – rigid – straight)
- 0120-16-16B - Fitting series
- 0120-16-16B - Size of fitting end connection (In this case, 16/16" or 1")
- 0120-16-16B - Hose size (In this case, 16/16" or 1")
- 0120-16-16B - Fitting material:
  - No Suffix = Steel
  - B = Brass
  - C = 316 Stainless Steel
  - BA = Brass Nipple with Steel Nut and Socket
  - BS = Brass Nipple with Brass Nut and Socket
  - SM = Metric Hex



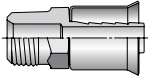
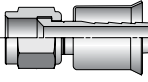
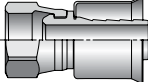
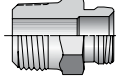

 <p><b>Flange</b></p>	<p>10125 B-6</p>  <p><i>Rigid</i></p>	<p>10825 B-6</p>  <p><i>Swivel</i></p>	<p>17B25 B-6</p>  <p><i>Swivel</i></p>	<p>017M B-6</p>  <p><i>Swivel</i></p>	<p>B-7</p> <p><i>Assembly Instructions</i></p>
--	--	---	--	--	--



## 10125 Male NPTF Pipe - Rigid

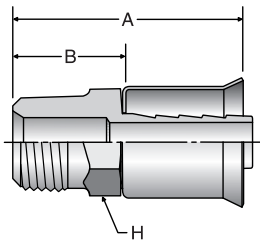

view on web page

# Part Number	Thread inch	Hose I.D. inch	A		H inch	B	
			inch	mm		inch	mm
10125-6-6B-VS	3/8X18	3/8	1.72	44	11/16	1.00	25
10125-6-8B-VS	3/8X18	1/2	1.72	44	11/16	1.00	25
10125-8-6B-VS	1/2X14	3/8	2.05	52	7/8	1.33	34
10125-8-8B-VS	1/2X14	1/2	2.05	52	7/8	1.33	34

**WARNING:** This product can expose you to chemicals including Lead, which is known to the State of California to cause cancer and birth defects or other reproductive harm. For more information go to [www.p65warnings.ca.gov](http://www.p65warnings.ca.gov).

## 10825 Female SAE 45° - Swivel

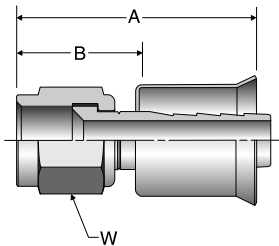

view on web page

# Part Number	Thread inch	Hose I.D. inch	A		H inch	B	
			inch	mm		inch	mm
10825-6-6B	5/8X18	3/8	1.82	46	3/4	1.10	28
10825-8-6B	3/4X16	3/8	1.80	46	7/8	1.08	27
10825-8-8B	3/4X16	1/2	1.95	50	7/8	1.22	31

**WARNING:** This product can expose you to chemicals including Lead, which is known to the State of California to cause cancer and birth defects or other reproductive harm. For more information go to [www.p65warnings.ca.gov](http://www.p65warnings.ca.gov).

## 17B25 Female Air Brake Jounce Line - Swivel - Straight

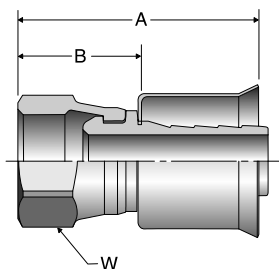

view on web page

# Part Number	Thread inch	Hose I.D. inch	A		H inch	B	
			inch	mm		inch	mm
17B25-8-6B	3/4X20	3/8	1.59	40	7/8	0.87	22
17B25-8-8B	3/4X20	1/2	1.59	40	7/8	0.87	22

**WARNING:** This product can expose you to chemicals including Lead, which is known to the State of California to cause cancer and birth defects or other reproductive harm. For more information go to [www.p65warnings.ca.gov](http://www.p65warnings.ca.gov).

## 017M Air Brake Adapter

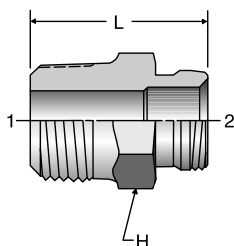

view on web page

# Part Number	Thread End 1 NPTF inch		Thread End 2 UNEFinch		L		H inch
	6	8	8	8	inch	mm	
017M-6-8B	3/8X18	6	3/4X20	8	1.13	29	3/4
017M-8-8B	1/2X14	8	3/4X20	8	1.33	34	7/8

**WARNING:** This product can expose you to chemicals including Lead, which is known to the State of California to cause cancer and birth defects or other reproductive harm. For more information go to [www.p65warnings.ca.gov](http://www.p65warnings.ca.gov).

## Assembly Instructions

1. On the 08 end configurations only, the use of a mandrel is required. This mandrel is designed to set the proper gap between the nut and the shell. To match the correct fitting with the proper mandrel part number refer to the table below.



2. The assembly mandrels can be used with a common bench vise or on the TH2-7 push-on stand. Refer to Bulletin 4480-T13-USA for push-on stand instructions.
3. When using a common bench vise, place the mandrel in the vise, put the fitting on the mandrel (nut first) then push on the hose until it bottoms. Visually check the sight hole on the side of the shell to assure that the hose is fully inserted.
4. Remove mandrel from fitting and check for proper gap between nut and shell. (See table below).
5. Now crimp the fitting onto the hose. Refer to CrimpSource for correct crimp dies and crimping dimensions.
6. Check for proper gap between nut and shell after crimp. (See table below)

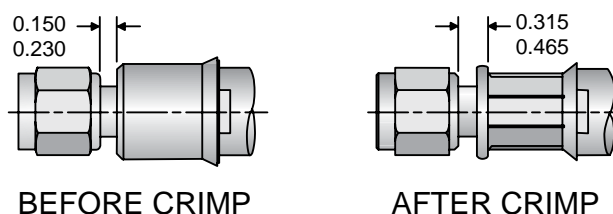

NOTE: B dimension is measured from the back of the fully-seated nut to the start of the crimp length. The nut must be free to swivel after crimping of the shell.

Fitting Part Number	Required Assembly Tool	A Length		B Length	
		mm	inch	mm	inch
10625-6-6B	TH2-7M25-6	3,80	0.150	8,00	0.310
10825-6-6B		5,85	0.230	11,80	0.465
10625-8-8B	TH2-7M25-8				
10825-8-8B					

NOTE: The "Required Assembly Tool" must be used to assemble all fittings listed above.

7. For all other 25 series fittings, use of mandrel is not necessary. Push fitting onto hose until it bottoms. Visually check sight hole on the side of the shell to assure that the hose is fully inserted.

*Notes*











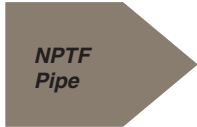
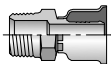

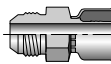
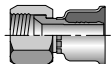
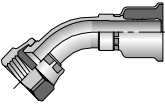
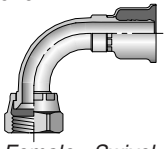
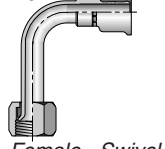

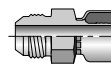
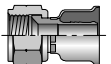
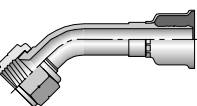
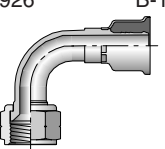

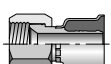
A

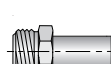
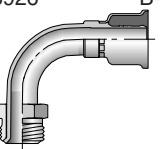

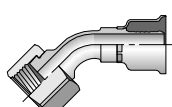
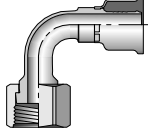

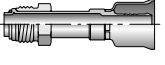
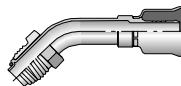
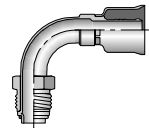
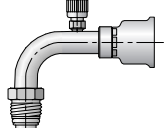
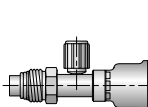
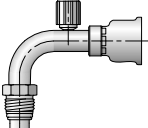
B

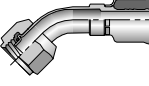
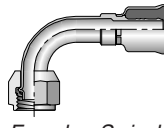
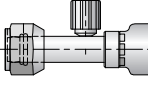
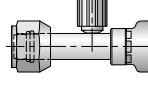
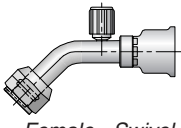
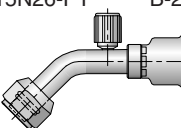
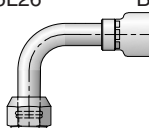
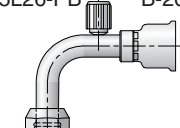
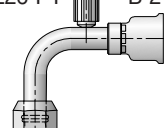
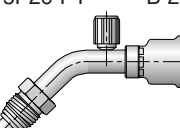
C

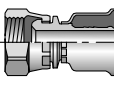
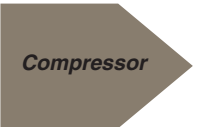
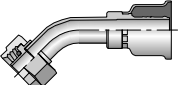
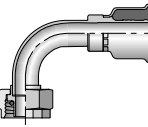
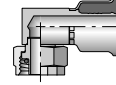
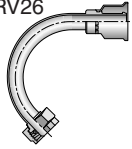
D

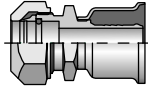
E

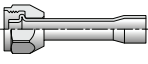
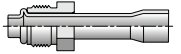
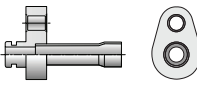
 <b>NPTF Pipe</b>	10126 B-11  <i>Male - Rigid</i>	 <b>JIC 37°</b>	10326 B-11  <i>Male - Rigid</i>	10626 B-12  <i>Female - Swivel</i>	13726 B-12  <i>Female - Swivel 45° Elbow - Short</i>
13926 B-12  <i>Female - Swivel 90° Elbow - Short</i>	14126 B-13  <i>Female - Swivel 90° Elbow - Long</i>	 <b>SAE 45°</b>	10426 B-13  <i>Male - Rigid</i>	10826 B-13  <i>Female - Swivel</i>	17726 B-13  <i>Female - Swivel 45° Elbow</i>
17926 B-14  <i>Female - Swivel 90° Elbow</i>	 <b>JIC 37°/ SAE 45° Dual Flare</b>	16826 B-14  <i>Female - Swivel</i>	 <b>Inverted Flare</b>	12826 B-14  <i>Male - Swivel</i>	16926 B-15  <i>Male - Swivel 90° Elbow</i>
 <b>Seal-Lok® (O-Ring Face Seal)</b>	1JC26 B-15  <i>Female - Swivel Short</i>	1J726 B-16  <i>Female - Swivel 45° Elbow</i>	1J926 B-16  <i>Female - Swivel 90° Elbow - Short</i>	 <b>Tube-O</b>	1S526 B-16  <i>Male - Swivel Short Pilot</i>
15R26 B-17  <i>Male - Swivel 45° Elbow - Short Pilot</i>	15K26 B-17  <i>Male - Swivel 90° Elbow - Short Pilot</i>	15K26-PB B-17  <i>Male - Swivel 90° Elbow - Short Pilot</i>	14526-PT B-18  <i>Male - Swivel Long Pilot</i>	15M26-PT B-18  <i>Male - Swivel 90° Elbow - Long Pilot</i>	15G26 B-18  <i>Male - Rigid Internal - Long Pilot</i>
15S26 B-18  <i>Female - Swivel Short Pilot</i>	15H26 B-19  <i>Female - Swivel 45° Elbow - Short Pilot</i>	15T26 B-19  <i>Female - Swivel 90° Elbow - Short Pilot</i>	15926-PB B-19  <i>Female - Swivel Long Pilot</i>	15926-PT B-19  <i>Female - Swivel Long Pilot</i>	15N26-PB B-20  <i>Female - Swivel 45° Elbow - Long Pilot</i>
15N26-PT B-20  <i>Female - Swivel 45° Elbow - Long Pilot</i>	15L26 B-20  <i>Female - Swivel 90° Elbow - Long Pilot</i>	15L26-PB B-20  <i>Female - Swivel 90° Elbow - Long Pilot</i>	15L26-PT B-21  <i>Female - Swivel 90° Elbow - Long Pilot</i>	15P26-PT B-21  <i>Male - Swivel 45° Elbow - Long Pilot</i>	 <b>Air Brake Jounce Line</b>
17B26 B-21  <i>Female - Swivel</i>	 <b>Compressor</b>	15V26 B-22  <i>Female - Swivel 45° Elbow</i>	15W26 B-22  <i>Female - Swivel 90° Elbow</i>	15Z26 B-22  <i>Female - Swivel 90° Elbow - Block Type</i>	1RV26 B-22  <i>Female - Swivel 135° Elbow</i>

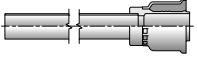
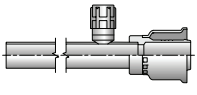
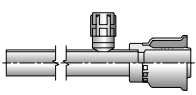
	1T126	B-23	1T126	B-23	14GZ	B-24	5SGZ	B-24	5SGZ	B-24
	 <p>Male (w/Nut &amp; Ferrule)</p>		<p>Fitting Assembly Instructions</p>		 <p>Male Insert O-ring Braze Nut</p>		 <p>Female Tube-O Swivel - Short Pilot</p>		 <p>Male Tube-O Swivel - Short Pilot</p>	
ZJGZ	B-25	ZKGZ	B-25	1ZG26	B-25	1ZG26-PB	B-25	1ZG26-PT	B-25	
 <p>Male "C" Plate Seal/ O-ring Block</p>		 <p>Male Encapsulated Slimline Seal Block</p>		 <p>Tube with 26 Series Coupling</p>		 <p>Tube with High Pressure Charge Port</p>		 <p>Tube with Low Pressure Charge Port</p>		

A

B

C

D

E

# 10126

## Male NPTF Pipe - Rigid

# Part Number	Thread		Hose I.D. inch	A		H		B		Additional Material Brass (B)
	inch	mm		inch	mm	inch	mm	inch	mm	
10126-2-4	1/8x27		3/16	1.65	42	7/16	0.78	0.78	20	
10126-4-4	1/4x18		3/16	1.88	48	9/16	1.01	1.01	26	
10126-4-5	1/4x18		1/4	1.88	48	9/16	1.01	1.01	26	
10126-4-6	1/4x18		5/16	1.88	48	3/4	1.02	1.02	26	•
10126-6-6	3/8x18		5/16	1.89	48	11/16	1.03	1.03	26	•
10126-6-8	3/8x18		13/32	1.89	48	11/16	1.03	1.03	26	•
10126-8-8	1/2x14		13/32	2.14	54	7/8	1.28	1.28	33	•
10126-8-10	1/2x14		1/2	2.25	57	7/8	1.30	1.30	33	•
10126-12-12	3/4x14		5/8	2.31	59	1-1/16	1.37	1.37	35	
10126-16-16	1x11-1/2		7/8	2.61	66	1-3/8	1.57	1.57	40	
10126-20-20	1-1/4x11-1/2		1-1/8	2.83	72	1-3/4	1.77	1.77	45	
10126-24-24	1-1/2x11-1/2		1-3/8	3.01	76	2	1.93	1.93	49	
10126-32-32	2x11-1/2		1-13/16	3.44	87	2-1/2	2.18	2.18	55	

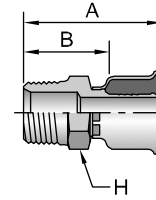

view on web page

**WARNING:** This product can expose you to chemicals including Lead, which is known to the State of California to cause cancer and birth defects or other reproductive harm. For more information go to [www.p65warnings.ca.gov](http://www.p65warnings.ca.gov).

# 10326

## Male JIC 37° - Rigid

# Part Number	Thread		Hose I.D. inch	A		H		B		Additional Material Brass (B)
	inch	mm		inch	mm	inch	mm	inch	mm	
10326-4-4	1/4	7/16x20	3/16	2.02	50	1/2	1.15	1.15	29	•
10326-6-6	3/8	9/16x18	5/16	2.12	54	3/4	1.26	1.26	32	
10326-8-8	1/2	3/4X16	13/32	1.94	49	13/16	1.08	1.08	27	
10326-10-10	5/8	7/8X14	1/2	2.49	64	15/16	1.54	1.54	39	

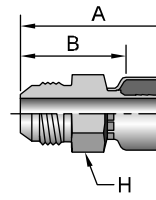

view on web page

**WARNING:** This product can expose you to chemicals including Lead, which is known to the State of California to cause cancer and birth defects or other reproductive harm. For more information go to [www.p65warnings.ca.gov](http://www.p65warnings.ca.gov).

### 10626 Female JIC 37° - Swivel

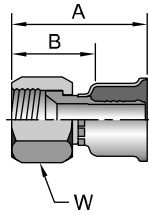

view on web page

# Part Number	Thread		Hose I.D. inch	A		W inch	B		Additional Material Brass (B)
	inch			inch	mm		inch	mm	
10626-6-6	3/8	9/16x18	5/16	1.81	45	11/16	0.95	23	•
10626-6-8	3/8	9/16x18	13/32	1.67	52	11/16	1.19	30	•
10626-12-12	3/4	1-1/16x12	5/8	2.29	58	1-1/4	1.35	34	•
10626-16-16	1	1-5/16x12	7/8	2.53	64	1-1/2	1.49	38	•
10626-20-20	1-1/4	1-5/8x12	1-1/8	2.56	65	2	1.50	38	
10626-24-24	1-1/2	1-7/8x12	1-3/8	2.77	70	2-1/4	1.69	43	
10626-32-32	2	2-1/2x12	1-13/16	3.30	84	2-7/8	2.04	52	

**WARNING:** This product can expose you to chemicals including Lead, which is known to the State of California to cause cancer and birth defects or other reproductive harm. For more information go to [www.p65warnings.ca.gov](http://www.p65warnings.ca.gov).

### 13726 Female JIC 37° - Swivel - 45° Elbow - Short Drop

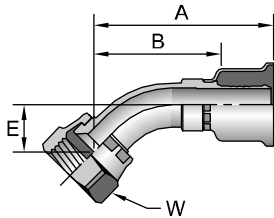

view on web page

# Part Number	Thread		Hose I.D. inch	A		E		W inch	B	
	inch			inch	mm	inch	mm		inch	mm
13726-4-4	1/4	7/16x20	3/16	2.01	51	0.39	10	9/16	1.14	29
13726-6-6	3/8	9/16x18	5/16	2.72	69	0.43	11	11/16	1.86	47
13726-8-8	1/2	3/4x16	13/32	2.82	72	0.55	15	7/8	1.96	50
13726-10-10	5/8	7/8x14	1/2	2.96	75	0.63	16	1	2.01	51
13726-12-12	3/4	1-1/16x12	5/8	3.44	87	0.83	21	1-1/4	2.50	63
13726-16-16	1	1-5/16x12	7/8	3.34	85	0.90	23	1-1/2	2.30	58
13726-20-20	1-1/4	1-5/8x12	1-1/8	3.74	95	1.18	30	2	2.68	68
13726-24-24	1-1/2	1-7/8x12	1-3/8	3.92	100	1.16	29	2-1/4	2.84	72

**WARNING:** This product can expose you to chemicals including Lead, which is known to the State of California to cause cancer and birth defects or other reproductive harm. For more information go to [www.p65warnings.ca.gov](http://www.p65warnings.ca.gov).

### 13926 Female JIC 37° - Swivel - 90° Elbow - Short Drop

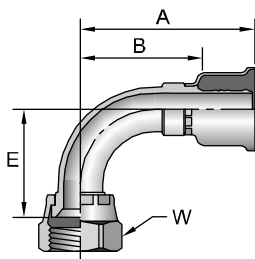

view on web page

# Part Number	Thread		Hose I.D. inch	A		E		W inch	B	
	inch			inch	mm	inch	mm		inch	mm
13926-4-4	1/4	7/16x20	3/16	1.82	46	0.83	21	9/16	0.95	24
13926-6-6	3/8	9/16x18	5/16	2.15	55	0.91	23	11/16	1.29	33
13926-8-8	1/2	3/4x16	13/32	2.22	56	1.09	28	7/8	1.36	35
13926-10-10	5/8	7/8x14	1/2	2.23	57	1.26	32	1	1.28	33
13926-10-12	5/8	7/8x14	5/8	2.52	64	1.23	31	1	1.58	40
13926-12-12	3/4	1-1/16x12	5/8	2.28	58	1.82	46	1-1/4	1.30	34
13926-16-16	1	1-5/16x12	7/8	3.30	84	2.14	54	1-1/2	2.26	57
13926-20-20	1-1/4	1-5/8x12	1-1/8	3.60	91	2.57	65	2	2.62	67
13926-24-24	1-1/2	1-7/8x12	1-3/8	3.92	100	2.82	72	2-1/4	2.84	72

**WARNING:** This product can expose you to chemicals including Lead, which is known to the State of California to cause cancer and birth defects or other reproductive harm. For more information go to [www.p65warnings.ca.gov](http://www.p65warnings.ca.gov).



# 14126

## Female JIC 37° - Swivel - 90° Elbow - Long Drop

# Part Number	Thread		Hose I.D. inch	A		E		W inch	B	
	inch	mm		inch	mm	inch	mm		inch	mm
14126-4-4	1/4	7/16x20	1/4	2.05	52	1.81	46	9/16	1.18	30
14126-6-6	3/8	9/16x18	5/16	2.02	51	2.13	54	11/16	1.16	29
14126-8-8	1/2	3/4x16	13/32	2.35	60	2.43	62	7/8	1.49	38
14126-10-10	5/8	7/8x14	1/2	2.11	54	2.76	70	1	1.16	29
14126-16-16	1	1-5/16x12	7/8	3.17	81	4.33	110	1-1/2	2.13	54

**WARNING:** This product can expose you to chemicals including Lead, which is known to the State of California to cause cancer and birth defects or other reproductive harm. For more information go to [www.p65warnings.ca.gov](http://www.p65warnings.ca.gov).

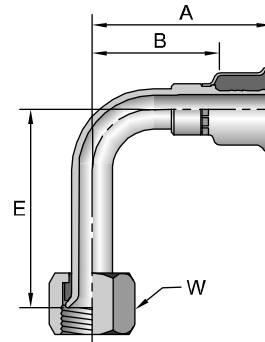

view on web page

# 10426

## Male SAE 45° - Rigid

# Part Number	Thread		Hose I.D. inch	A		H inch	B	
	inch	mm		inch	mm		inch	mm
10426-6-6	3/8	5/8x18	5/16	2.04	52	11/16	1.18	30

**WARNING:** This product can expose you to chemicals including Lead, which is known to the State of California to cause cancer and birth defects or other reproductive harm. For more information go to [www.p65warnings.ca.gov](http://www.p65warnings.ca.gov).

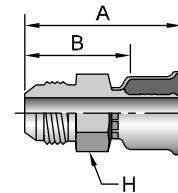

view on web page

# 10826

## Female SAE 45° - Swivel

# Part Number	Thread		Hose I.D. inch	A		W inch	B		Additional Material Brass (B)
	inch	mm		inch	mm		inch	mm	
10826-6-6	3/8	5/8x18	5/16	1.84	47	3/4	0.98	25	•
10826-10-8	5/8	7/8x14	13/32	2.21	56	1	1.35	34	
10826-10-10	5/8	7/8x14	1/2	2.13	54	1	1.18	30	
10826-12-12	3/4	1-1/16x14	5/8	2.19	56	1-1/4	1.25	32	•

**WARNING:** This product can expose you to chemicals including Lead, which is known to the State of California to cause cancer and birth defects or other reproductive harm. For more information go to [www.p65warnings.ca.gov](http://www.p65warnings.ca.gov).

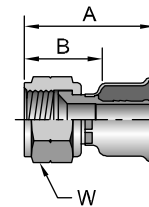

view on web page

# 17726

## Female SAE 45° - Swivel - 45° Elbow

# Part Number	Thread		Hose I.D. inch	A		E		W inch	B	
	inch	mm		inch	mm	inch	mm		inch	mm
17726-4-4	1/4	7/16x20	3/16	2.29	58	0.39	10	9/16	1.43	36
17726-6-6	3/8	5/8x18	5/16	2.72	69	0.43	11	11/16	1.86	47
17726-8-8	1/2	3/4x16	13/32	2.82	72	0.59	14	7/8	1.96	50
17726-10-10	5/8	7/8x14	1/2	2.96	75	0.63	16	1	2.01	51
17726-12-12	3/4	1-1/16x14	5/8	3.43	87	0.83	21	1-1/4	2.49	63

**WARNING:** This product can expose you to chemicals including Lead, which is known to the State of California to cause cancer and birth defects or other reproductive harm. For more information go to [www.p65warnings.ca.gov](http://www.p65warnings.ca.gov).

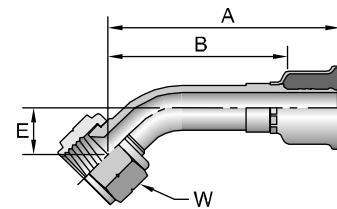

view on web page

Notch on nut signifies SAE 45° flare fitting.

# 17926

## Female SAE 45° - Swivel - 90° Elbow

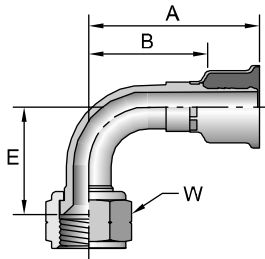

view on web page

# Part Number	Thread		Hose I.D. inch	A		E		W inch	B	
	inch	mm		inch	mm	inch	mm		inch	mm
17926-4-4	1/4	7/16x20	3/16	1.75	44	0.83	21	9/16	0.89	23
17926-6-6	3/8	5/8x18	5/16	2.15	55	0.91	23	3/4	1.29	33
17926-8-8	1/2	3/4x16	13/32	2.31	58.7	1.00	25.4	7/8	1.45	37
17926-10-10	5/8	7/8x14	1/2	2.23	57	1.26	32	1	1.28	33
17926-12-12	3/4	1-1/16x14	5/8	2.28	58	1.82	46	1-1/4	1.34	34

Notch on nut signifies 45° flare fitting.

**WARNING:** This product can expose you to chemicals including Lead, which is known to the State of California to cause cancer and birth defects or other reproductive harm. For more information go to [www.p65warnings.ca.gov](http://www.p65warnings.ca.gov).

# 16826

## Female JIC 37° / SAE 45° - Dual Flare - Swivel

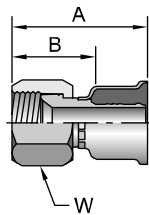

view on web page

# Part Number	Thread		Hose I.D. inch	A		W inch	B		Additional Material Brass (B)
	inch	mm		inch	mm		inch	mm	
16826-4-4	1/4	7/16x20	3/16	1.67	42	9/16	0.80	20	•
16826-4-5	1/4	7/16x20	1/4	1.55	48	9/16	1.03	26	
16826-4-6	1/4	7/16x20	5/16	1.92	49	9/16	1.06	27	
16826-5-5	5/16	1/2x20	1/4	1.77	45	5/8	0.90	23	
16826-8-6	1/2	3/4x16	5/16	1.76	56	7/8	1.34	34	
16826-8-8	1/2	3/4x16	13/32	1.91	49	7/8	1.05	27	
16826-8-10	1/2	3/4x16	1/2	2.36	60	7/8	1.41	36	•
16826-10-10	5/8	7/8x14	1/2	2.17	55	1	1.23	31	•
16826-10-12	5/8	7/8x14	5/8	1.96	61	1	1.53	37	

**WARNING:** This product can expose you to chemicals including Lead, which is known to the State of California to cause cancer and birth defects or other reproductive harm. For more information go to [www.p65warnings.ca.gov](http://www.p65warnings.ca.gov).

# 12826

## Male Inverted SAE 45° - Swivel

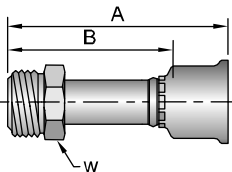

view on web page

# Part Number	Thread		Hose I.D. inch	A		W inch	B	
	inch	mm		inch	mm		inch	mm
12826-4-4	1/4	7/16x24	3/16	2.43	62	7/16	1.56	40
12826-5-5	5/16	1/2x20	1/4	2.56	65	1/2	1.69	43
12826-6-6	3/8	5/8x18	5/16	2.87	73	5/8	2.01	51
12826-8-8	1/2	3/4x18	13/32	3.00	76	3/4	2.14	54
12826-10-10	5/8	7/8x18	1/2	3.17	81	7/8	2.22	56

**WARNING:** This product can expose you to chemicals including Lead, which is known to the State of California to cause cancer and birth defects or other reproductive harm. For more information go to [www.p65warnings.ca.gov](http://www.p65warnings.ca.gov).

# 16926

## Male Inverted SAE 45° - Swivel - 90° Elbow

# Part Number	Thread		Hose I.D. inch	A		E		W		B	
	inch			inch	mm	inch	mm	inch	inch	inch	mm
16926-4-4	1/4	7/16x24	3/16	2.27	58	1.56	40	7/16	1.40	36	
16926-6-6	3/8	5/8x18	5/16	1.89	48	1.48	38	5/8	1.03	26	
16926-8-8	1/2	3/4x18	13/32	2.25	57	1.88	48	3/4	1.39	35	

**WARNING:** This product can expose you to chemicals including Lead, which is known to the State of California to cause cancer and birth defects or other reproductive harm. For more information go to [www.p65warnings.ca.gov](http://www.p65warnings.ca.gov).

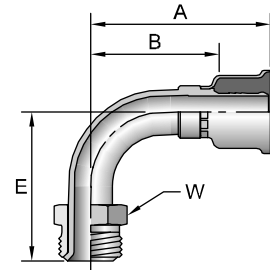

view on web page

# 1JC26

## Female Seal-Lok® - Swivel - Short

# Part Number	Thread		Hose I.D. inch	A		C		H	W	B	
	inch			inch	mm	inch	mm	inch	inch	inch	mm
1JC26-4-4	1/4	9/16x18	3/16	1.66	42	0.31	8	9/16	11/16	0.79	20
1JC26-6-6	3/8	11/16x16	5/16	1.70	43	0.34	9	11/16	13/16	0.84	21
1JC26-8-8	1/2	13/16x16	13/32	1.76	45	0.43	11	13/16	15/16	0.90	23
1JC26-10-10	5/8	1x14	1/2	2.16	55	0.53	13	15/16	1-1/8	1.21	31
1JC26-12-12	3/4	1-3/16x12	5/8	2.13	54	0.55	14	1-1/8	1-3/8	1.19	30
1JC26-16-16	1	1-7/16x12	7/8	2.39	61	0.56	14	1-3/8	1-5/8	1.35	34
1JC26-20-20	1-1/4	1-11/16x12	1-1/8	2.45	62	0.59	15	1-7/8	1-7/8	1.39	35

When measuring overall length to the end of the nut, B + C must be used to calculate cut-off allowance. See Accessories Section for O-Rings.

**WARNING:** This product can expose you to chemicals including Lead, which is known to the State of California to cause cancer and birth defects or other reproductive harm. For more information go to [www.p65warnings.ca.gov](http://www.p65warnings.ca.gov).

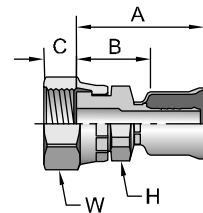

view on web page

## 1J726

### Female Seal-Lok® - Swivel - 45° Elbow

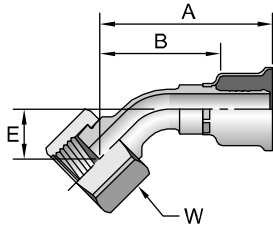

view on web page

# Part Number	Thread		Hose I.D. inch	A		E		W		B	
	inch	mm		inch	mm	inch	mm	inch	mm	inch	mm
1J726-4-4	1/4	9/16x18	3/16	1.99	51	0.39	10	11/16	1.12	28	
1J726-6-6	3/8	11/16x16	5/16	2.43	62	0.43	11	13/16	1.57	40	
1J726-8-8	1/2	13/16x16	13/32	2.77	70	0.59	15	15/16	1.91	49	
1J726-10-10	5/8	1x14	1/2	3.26	83	0.63	16	1-1/8	2.31	59	
1J726-12-12	3/4	1-3/16x12	5/8	3.13	80	0.83	21	1-3/8	2.19	56	
1J726-16-16	1	1-7/16x12	7/8	3.61	92	0.94	24	1-5/8	2.57	65	
1J726-20-20	1-1/4	1-11/16x12	1-1/8	3.93	100	1.00	25	1-7/8	2.87	73	

**WARNING:** This product can expose you to chemicals including Lead, which is known to the State of California to cause cancer and birth defects or other reproductive harm. For more information go to [www.p65warnings.ca.gov](http://www.p65warnings.ca.gov).

## 1J926

### Female Seal-Lok® - Swivel - 90° Elbow - Short Drop

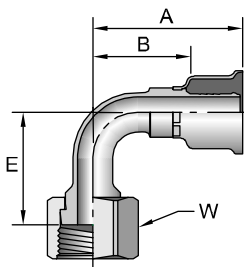

view on web page

# Part Number	Thread		Hose I.D. inch	A		E		W		B	
	inch	mm		inch	mm	inch	mm	inch	mm	inch	mm
1J926-4-4	1/4	9/16x18	3/16	1.80	46	0.83	21	11/16	0.93	24	
1J926-6-6	3/8	11/16x16	5/16	1.86	47	0.91	23	13/16	1.00	25	
1J926-8-8	1/2	13/16x16	13/32	2.14	54	1.14	29	15/16	1.28	33	
1J926-10-10	5/8	1x14	1/2	2.53	64	1.26	32	1-1/8	1.58	40	
1J926-12-12	3/4	1-3/16x12	5/8	2.51	64	1.89	48	1-3/8	1.57	40	
1J926-16-16	1	1-7/16x12	7/8	3.56	90	2.21	56	1-5/8	2.52	64	
1J926-20-20	1-1/4	1-11/16x12	1-1/8	4.05	103	2.51	64	1-7/8	2.99	76	

**WARNING:** This product can expose you to chemicals including Lead, which is known to the State of California to cause cancer and birth defects or other reproductive harm. For more information go to [www.p65warnings.ca.gov](http://www.p65warnings.ca.gov).

## 1S526

### Male Tube-O - Swivel - Short Pilot

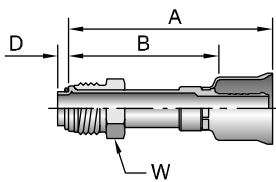

view on web page

# Part Number	Thread		Hose I.D. inch	A		D		W		B	
	inch	mm		inch	mm	inch	mm	inch	mm	inch	mm
1S526-6-6	3/8	5/8x18	5/16	2.54	65	0.18	4,7	5/8	1.68	43	
1S526-8-8	1/2	3/4x18	13/32	2.68	68	0.18	4,7	3/4	1.82	46	
1S526-10-10	5/8	7/8x18	1/2	3.46	88	0.18	4,7	7/8	2.51	64	
1S526-10-12	5/8	7/8x18	5/8	3.63	92	0.18	4,7	7/8	2.69	68	
1S526-12-12	3/4	1-1/16x16	5/8	4.00	102	0.18	4,7	1-1/16	3.06	78	

When measuring overall length to the end of the nut, B+D must be used to calculate cut-off allowance.

**WARNING:** This product can expose you to chemicals including Lead, which is known to the State of California to cause cancer and birth defects or other reproductive harm. For more information go to [www.p65warnings.ca.gov](http://www.p65warnings.ca.gov).

See Accessories Section for O-Rings.

# 15R26

## Male Tube-O - Swivel - 45° Elbow - Short Pilot

Part Number	Thread		Hose I.D.	A		D		E		W	B	
	inch	inch		inch	mm	inch	mm	inch	mm		inch	inch
15R26-6-6	3/8	5/8x18	5/16	2.52	64	0.18	4,7	0.85	22	5/8	1.66	42
15R26-8-8	1/2	3/4x18	13/32	2.53	64	0.18	4,7	1.05	27	3/4	1.67	42
15R26-10-10	5/8	7/8x18	1/2	2.99	76	0.18	4,7	1.25	32	7/8	2.04	52
15R26-10-12	5/8	7/8x18	5/8	3.16	80	0.18	4,7	1.25	32	7/8	2.22	56

**WARNING:** This product can expose you to chemicals including Lead, which is known to the State of California to cause cancer and birth defects or other reproductive harm. For more information go to [www.p65warnings.ca.gov](http://www.p65warnings.ca.gov).

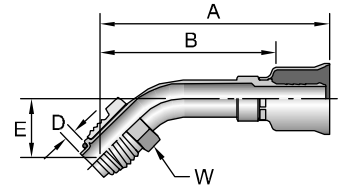

view on web page

# 15K26

## Male Tube-O - Swivel - 90° Elbow - Short Pilot

# Part Number	Thread		Hose I.D.	A		D		E		W	B	
	inch	inch		inch	mm	inch	mm	inch	mm		inch	inch
15K26-6-6	3/8	5/8X18	5/16	2.06	52	0.18	4,7	1.76	45	5/8	1.19	30
15K26-8-8	1/2	3/4x18	13/32	2.06	52	0.18	4,7	1.74	44	3/4	1.20	30
15K26-10-10	5/8	7/8x18	1/2	2.34	59	0.18	4,7	2.20	56	7/8	1.39	35
15K26-10-12	5/8	7/8x18	5/8	2.51	64	0.18	4,7	2.20	56	7/8	1.57	40

**WARNING:** This product can expose you to chemicals including Lead, which is known to the State of California to cause cancer and birth defects or other reproductive harm. For more information go to [www.p65warnings.ca.gov](http://www.p65warnings.ca.gov).

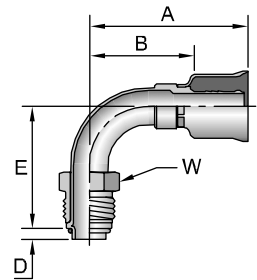

view on web page

# 15K26-PB

## Male Tube-O - Swivel - 90° Elbow - Short Pilot with High Pressure Charge Port for R134a

# Part Number	Thread		Hose I.D.	A		D		E		G		W	B	
	inch	inch		inch	mm	inch	mm	inch	mm	inch	mm		inch	inch
15K26-8-8-PB	1/2	3/4x18	13/32	2.70	69	0.18	4,6	1.74	44	0.60	15	3/4	1.88	48

**WARNING:** This product can expose you to chemicals including Lead, which is known to the State of California to cause cancer and birth defects or other reproductive harm. For more information go to [www.p65warnings.ca.gov](http://www.p65warnings.ca.gov).

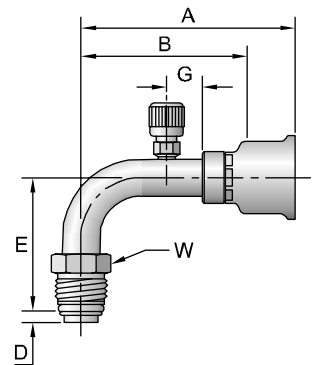

view on web page

### 14526-PT

Male Tube-O - Swivel - Long Pilot With Low Pressure Charge Port for R134a

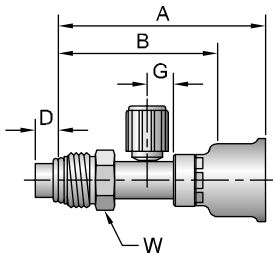

view on web page

# Part Number	Thread		Hose I.D.		A		D		G		W		B	
	inch	mm	inch	mm	inch	mm	inch	mm	inch	mm	inch	mm	inch	mm
14526-10-12-PT	5/8	7/8x18	5/8	3.45	88	0.38	9,8	0.44	11	7/8	2.51	64		

**WARNING:** This product can expose you to chemicals including Lead, which is known to the State of California to cause cancer and birth defects or other reproductive harm. For more information go to [www.p65warnings.ca.gov](http://www.p65warnings.ca.gov).

### 15M26-PT

Male Tube-O - Swivel - 90° Elbow - Long Pilot With Low Pressure Charge Port for R134a

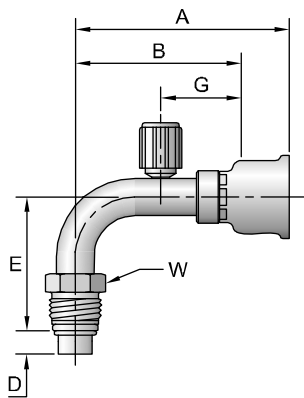

view on web page

# Part Number	Thread		Hose I.D.		A		D		E		G		W		B	
	inch	mm	inch	mm	inch	mm	inch	mm	inch	mm	inch	mm	inch	mm	inch	mm
15M26-10-12-PT	5/8	7/8x18	5/8	3.25	83	0.38	9,8	2.25	57	0.60	15	7/8	2.31	59		

**WARNING:** This product can expose you to chemicals including Lead, which is known to the State of California to cause cancer and birth defects or other reproductive harm. For more information go to [www.p65warnings.ca.gov](http://www.p65warnings.ca.gov).

### 15G26

Male Tube-O - Rigid - Internal Long Pilot (3-Step)

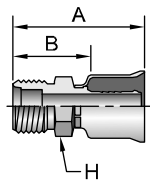

view on web page

# Part Number	Thread		Hose I.D.		A		H		B	
	inch	mm	inch	mm	inch	mm	inch	mm	inch	mm
15G26-6-6	3/8	5/8x18	5/16	1.78	45	0.625	0.92	23		
15G26-8-8	1/2	3/4x16	13/32	1.95	50	3/4	1.09	28		
15G26-10-10	5/8	7/8x14	1/2	4.05	103	7/8	3.10	79		
15G26-10-12	5/8	7/8x14	5/8	2.19	56	0.875	1.25	32		

**WARNING:** This product can expose you to chemicals including Lead, which is known to the State of California to cause cancer and birth defects or other reproductive harm. For more information go to [www.p65warnings.ca.gov](http://www.p65warnings.ca.gov).

### 15S26

Female Tube-O - Swivel - Short Pilot

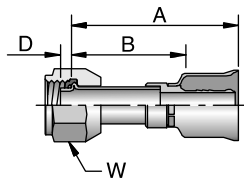

view on web page

# Part Number	Thread		Hose I.D.		A		D		W		B	
	inch	mm	inch	mm	inch	mm	inch	mm	inch	mm	inch	mm
15S26-6-6	3/8	5/8x18	5/16	2.54	65	0.18	4,7	3/4	1.68	43		
15S26-8-8	1/2	3/4x16	13/32	2.68	68	0.18	4,7	7/8	1.82	46		
15S26-10-10	5/8	7/8x14	1/2	2.84	72	0.18	4,7	1-1/16	1.89	48		
15S26-10-12	5/8	7/8x14	5/8	3.63	92	0.18	4,7	1-1/16	2.69	68		
15S26-12-12	3/4	1-1/16x14	5/8	4.00	102	0.18	4,7	1-1/4	3.06	78		

**WARNING:** This product can expose you to chemicals including Lead, which is known to the State of California to cause cancer and birth defects or other reproductive harm. For more information go to [www.p65warnings.ca.gov](http://www.p65warnings.ca.gov).

## 15H26

### Female Tube-O - Swivel 45° Elbow - Short Pilot

# Part Number	Thread		Hose I.D. inch	A		D		E		W inch	B	
	inch	mm		inch	mm	inch	mm	inch	mm		inch	mm
15H26-6-6	3/8	5/8x18	5/16	2.35	60	0.18	4,7	0.54	14	3/4	1.49	38
15H26-8-8	1/2	3/4x16	13/32	2.48	63	0.18	4,7	0.60	15	7/8	1.62	41
15H26-10-10	5/8	7/8x14	1/2	3.23	82	0.18	4,7	0.67	17	1 1/16	2.28	58
15H26-10-12	5/8	7/8x14	5/8	3.43	87	0.18	4,7	0.67	17	1-1/16	2.46	62

**WARNING:** This product can expose you to chemicals including Lead, which is known to the State of California to cause cancer and birth defects or other reproductive harm. For more information go to [www.p65warnings.ca.gov](http://www.p65warnings.ca.gov).

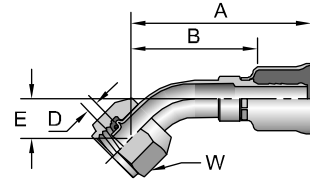

view on web page

## 15T26

### Female Tube-O - Swivel - 90° Elbow - Short Pilot

# Part Number	Thread		Hose I.D. inch	A		D		E		W inch	B	
	inch	mm		inch	mm	inch	mm	inch	mm		inch	mm
15T26-6-6	3/8	5/8x18	5/16	1.89	48	0.18	4,7	1.15	29	3/4	1.03	26
15T26-8-8	1/2	3/4x16	13/32	2.34	59	0.18	4,7	1.46	37	7/8	1.48	38
15T26-10-10	5/8	7/8x14	1/2	2.08	53	0.18	4,7	1.75	44	1-1/16	1.08	27
15T26-10-12	5/8	7/8x14	5/8	2.20	56	0.18	4,7	1.53	39	1-1/16	1.26	32
15T26-12-12	3/4	1-1/16x14	5/8	2.63	67	0.18	4,7	1.75	44	1-1/4	1.69	43

**WARNING:** This product can expose you to chemicals including Lead, which is known to the State of California to cause cancer and birth defects or other reproductive harm. For more information go to [www.p65warnings.ca.gov](http://www.p65warnings.ca.gov).

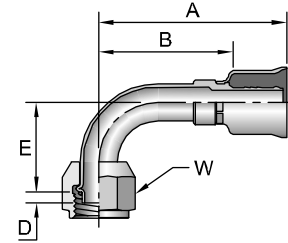

view on web page

## 15926-PB

### Female Tube-O - Swivel - Long Pilot With High Pressure Charge Port for R134a

# Part Number	Thread		Hose I.D. inch	A		D		G		W inch	B	
	inch	mm		inch	mm	inch	mm	inch	mm		inch	mm
15926-6-6-PB	3/8	5/8x18	5/16	3.25	83	0.28	7,1	0.75	19	3/4	2.39	61
15926-8-8-PB	1/2	3/4x16	13/32	2.74	70	0.38	9,8	0.50	13	7/8	1.88	48

**WARNING:** This product can expose you to chemicals including Lead, which is known to the State of California to cause cancer and birth defects or other reproductive harm. For more information go to [www.p65warnings.ca.gov](http://www.p65warnings.ca.gov).

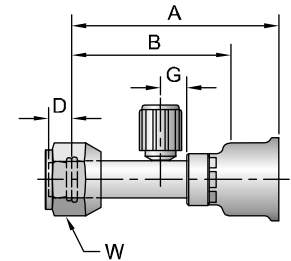

view on web page

## 15926-PT

### Female Tube-O - Swivel - Long Pilot With Low Pressure Charge Port for R134a

# Part Number	Thread		Hose I.D. inch	A		D		G		W inch	B	
	inch	mm		inch	mm	inch	mm	inch	mm		inch	mm
15926-10-12-PT	5/8	7/8x14	5/8	3.47	88	0.38	9,8	0.60	15	1-1/16	2.53	64

**WARNING:** This product can expose you to chemicals including Lead, which is known to the State of California to cause cancer and birth defects or other reproductive harm. For more information go to [www.p65warnings.ca.gov](http://www.p65warnings.ca.gov).

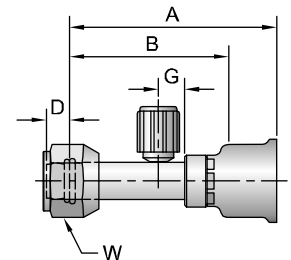

view on web page

### 15N26-PB

Female Tube-O - Swivel - 45° Elbow - Long Pilot  
With High Pressure Charge Port for R134a

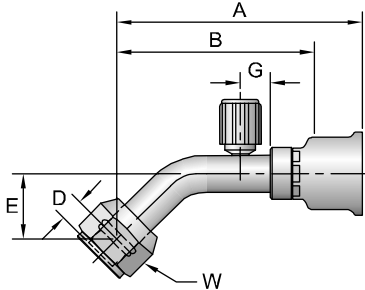

view on web page

# Part Number	Thread inch	Hose I.D. inch	A inch mm		D inch mm		E inch mm		G inch mm		W inch	B inch mm	
15N26-8-8-PB	1/2 3/4x16	13/32	3.67	93	0.38	9,8	0.90	23	0.60	15	7/8	2.81	72

**WARNING:** This product can expose you to chemicals including Lead, which is known to the State of California to cause cancer and birth defects or other reproductive harm. For more information go to [www.p65warnings.ca.gov](http://www.p65warnings.ca.gov).

### 15N26-PT

Female Tube-O - Swivel - 45° Elbow - Long Pilot  
With Low Pressure Charge Port for R134a

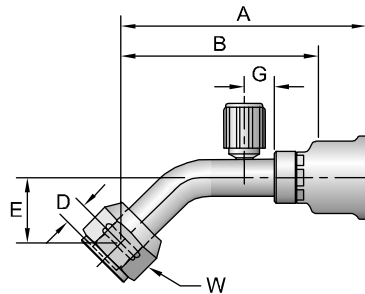

view on web page

# Part Number	Thread inch	Hose I.D. inch	A inch mm		D inch mm		E inch mm		G inch mm		W inch	B inch mm	
15N26-10-12-PT	5/8 7/8x14	5/8	3.92	100	0.38	9,8	1.21	31	0.60	15	1-1/16	2.98	76

**WARNING:** This product can expose you to chemicals including Lead, which is known to the State of California to cause cancer and birth defects or other reproductive harm. For more information go to [www.p65warnings.ca.gov](http://www.p65warnings.ca.gov).

### 15L26

Female Tube-O - Swivel - 90° Elbow - Long Pilot

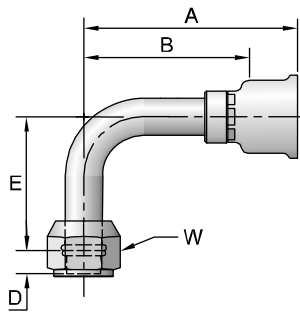

view on web page

# Part Number	Thread inch	Hose I.D. inch	A inch mm		D inch mm		E inch mm		W inch	B inch mm	
15L26-8-8	1/2 3/4x16	13/32	2.14	54	0.38	9,8	1.46	37	7/8	1.28	33

**WARNING:** This product can expose you to chemicals including Lead, which is known to the State of California to cause cancer and birth defects or other reproductive harm. For more information go to [www.p65warnings.ca.gov](http://www.p65warnings.ca.gov).

### 15L26-PB

Female Tube-O - Swivel - 90° Elbow - Long Pilot  
With High Pressure Charge Port for R134a

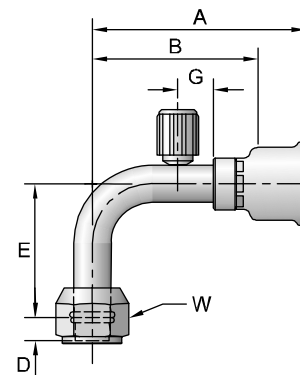

view on web page

# Part Number	Thread inch	Hose I.D. inch	A inch mm		D inch mm		E inch mm		G inch mm		W inch	B inch mm	
15L26-6-6-PB	3/8 5/8x18	5/16	2.50	64	0.28	7,1	1.22	31	0.50	13	3/4	1.64	42
15L26-8-8-PB	1/2 3/4x16	13/32	2.80	71	0.38	9,8	1.46	37	0.60	15	7/8	1.94	49

**WARNING:** This product can expose you to chemicals including Lead, which is known to the State of California to cause cancer and birth defects or other reproductive harm. For more information go to [www.p65warnings.ca.gov](http://www.p65warnings.ca.gov).



### 15L26-PT

Female Tube-O - Swivel - 90° Elbow - Long Pilot  
With Low Pressure Charge Port for R134a

Part Number	Thread		Hose I.D.	A		D		E		G		W		B	
	inch	inch		inch	mm	inch	mm	inch	mm	inch	mm	inch	mm	inch	mm
15L26-10-10-PT	5/8	7/8X14	1/2	2.95	75	0.38	9,8	2.25	57	0.60	15	1-1/16	2.00	51	
15L26-10-12-PT	5/8	7/8x14	5/8	3.25	83	0.38	9,8	2.25	57	0.60	15	1-1/16	2.31	59	

**WARNING:** This product can expose you to chemicals including Lead, which is known to the State of California to cause cancer and birth defects or other reproductive harm. For more information go to [www.p65warnings.ca.gov](http://www.p65warnings.ca.gov).

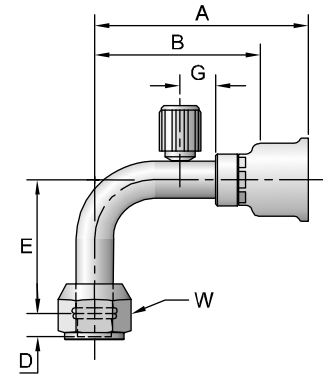

view on web page

### 15P26-PT

Male Tube-O - Swivel - 45° Elbow - Long Pilot  
With Low Pressure Charge Port for R134a

# Part Number	Thread		Hose I.D.	A		D		E		G		W	B	
	inch	inch		inch	mm	inch	mm	inch	mm	inch	mm		inch	mm
15P26-10-12-PT	5/8	7/8x18	5/8	3.81	97	0.38	9,8	1.21	31	0.60	15	7/8	2.87	73

**WARNING:** This product can expose you to chemicals including Lead, which is known to the State of California to cause cancer and birth defects or other reproductive harm. For more information go to [www.p65warnings.ca.gov](http://www.p65warnings.ca.gov).

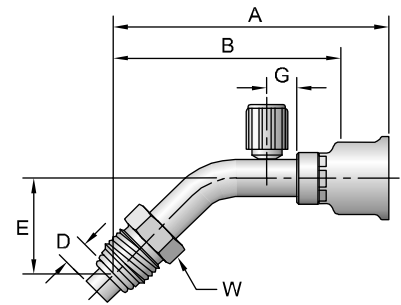

view on web page

### 17B26

Female Air Brake Jounce Line - Swivel

# Part Number	Thread		Hose inch	A		W	B	
	inch	inch		inch	mm		inch	mm
17B26-8-6BA	1/2	3/4x20	5/16	1.75	44	11/16	0.89	23
17B26-8-8BA	1/2	3/4x20	13/32	1.75	44	11/16	0.89	23

**WARNING:** This product can expose you to chemicals including Lead, which is known to the State of California to cause cancer and birth defects or other reproductive harm. For more information go to [www.p65warnings.ca.gov](http://www.p65warnings.ca.gov).

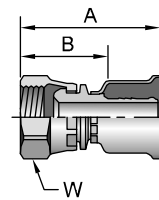

view on web page

### 15V26 Female Compressor - Swivel - 45° Elbow

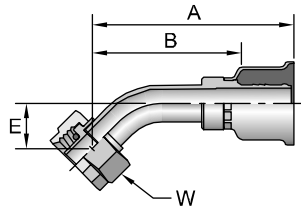

view on web page

# Part Number	Thread inch	Hose I.D. inch	A		E		W		
			inch	mm	inch	mm	inch	inch	mm
15V26-12-8	1x14	13/32	2.72	69	0.75	19	1-1/8	1.86	47
15V26-12-12	1x14	5/8	3.39	86	0.76	19	1-1/8	2.45	62

**WARNING:** This product can expose you to chemicals including Lead, which is known to the State of California to cause cancer and birth defects or other reproductive harm. For more information go to [www.p65warnings.ca.gov](http://www.p65warnings.ca.gov).

### 15W26 Female Compressor - Swivel - 90° Elbow

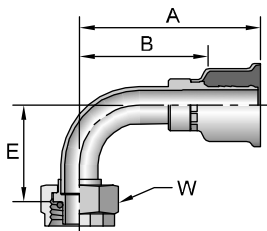

view on web page

# Part Number	Thread inch	Hose I.D. inch	A		E		W		
			inch	mm	inch	mm	inch	inch	mm
15W26-12-8	1x14	13/32	2.24	57	1.25	32	1.125	1.38	35
15W26-12-12	1x14	5/8	3.04	77	1.63	41	1.125	2.10	53

**WARNING:** This product can expose you to chemicals including Lead, which is known to the State of California to cause cancer and birth defects or other reproductive harm. For more information go to [www.p65warnings.ca.gov](http://www.p65warnings.ca.gov).

### 15Z26 Female Compressor - Swivel - 90° Elbow - Block Type

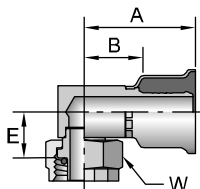

view on web page

# Part Number	Thread inch	Hose I.D. inch	A		E		W		
			inch	mm	inch	mm	inch	inch	mm
15Z26-12-8	1X14	13/32	1.79	45	0.80	20	1.125	0.93	24
15Z26-12-12	1X14	5/8	1.87	47	0.80	20	1.125	0.93	24

**WARNING:** This product can expose you to chemicals including Lead, which is known to the State of California to cause cancer and birth defects or other reproductive harm. For more information go to [www.p65warnings.ca.gov](http://www.p65warnings.ca.gov).

### 1RV26 Female Compressor - Swivel - 135° Elbow

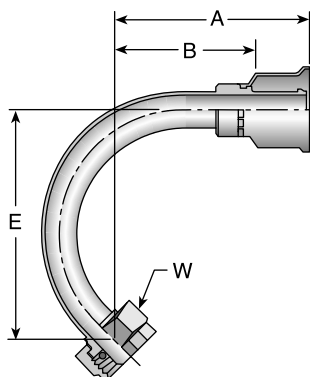

view on web page

# Part Number	Hose I.D. inch	A		E		W		
		inch	mm	inch	mm	inch	inch	mm
1RV26-12-8	13/32	3.24	82	3.21	82	1-1/8	2.38	60
1RV26-12-12	5/8	2.32	59	3.21	82	1-1/8	1.38	35

**WARNING:** This product can expose you to chemicals including Lead, which is known to the State of California to cause cancer and birth defects or other reproductive harm. For more information go to [www.p65warnings.ca.gov](http://www.p65warnings.ca.gov).

# 1T126

## Male Refrigerant Tube Mender (with Nut and Ferrule)

# Part Number	Thread		Hose I.D. inch	A		H inch	B	
	inch	inch		inch	mm		inch	mm
1T126-6-6	3/8	5/8x18	5/16	1.96	50	11/16	1.10	28
1T126-8-8	1/2	3/4x16	13/32	2.07	53	13/16	1.21	31
1T126-10-10	5/8	7/8x14	1/2	2.28	58	15/16	1.33	34
1T126-10-12	5/8	7/8x14	5/8	2.27	58	15/16	1.33	34
1T126-12-12	3/4	1-1/16x14	5/8	2.33	59	1-1/8	1.39	35

1T126 Assembly instructions below.

**WARNING:** This product can expose you to chemicals including Lead, which is known to the State of California to cause cancer and birth defects or other reproductive harm. For more information go to [www.p65warnings.ca.gov](http://www.p65warnings.ca.gov).

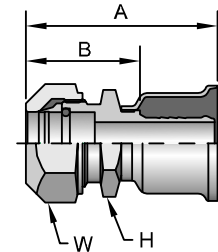

[view on web page](#)

# 1T126

## Fitting Installation Instructions

1. Cut the tube off squarely next to the hose fitting. At least 7/8" straight length is required and the outside diameter of the tube should be smooth and free from deep lengthwise scratches.
2. To prevent cutting the inside of the O-Ring, smoothly chamfer the outside diameter of the cut end 15° to 30°. Deburr the inside diameter.
3. Remove the nut, compression sleeve, and O-Ring from the fitting and lubricate the O-Ring with a lubricant that is compatible with the refrigerant used in the system.
4. Place the lubricated O-Ring in the counterbore of the fitting.
5. Slip the compression sleeve, small end, into the nut and assemble the nut on the fitting fingertight. Make sure the compression sleeve is not cocked in the nut. Back the nut off 1/6 to 1/3 turn (one to two hex flats).
6. Insert the chamfered tube end through the nut into the fitting. If high resistance is felt when the end of the tube contacts the O-Ring, remove the tube. The end of the tube may require a large chamfer and/or the O-Ring may require more lubrication on the inside diameter. Repeat the previous steps.
7. (a) Make sure the tube is bottomed in the fitting  
(b) Tighten the nut fingertight  
(c) Mark the fitting and nut hex indicating the starting point (see illustration)  
(d) Wrench tighten the nut 1 to 1-1/6 turns (6 to 7 hex flats).
8. Later, if it is ever necessary to loosen the connection, re-assemble the nut 1/6 turn (one hex flat) after finger tight.

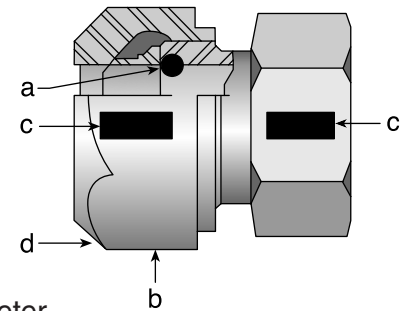

Hose Products Division prides itself on delivering exceptional quality and reliability when it comes to air conditioning components. Parker's male and female end tube connections with or without a pilot as well as our 26 series fittings for hose connections were specifically designed for the rigorous requirements of automotive, mobile, bus and transit applications. Utilizing both of these types of fittings as well as our 285 hose will give you the ability to make your own custom hose tube assembly for air conditioner applications.

## 14GZ Male Insert O-ring Braze Nut

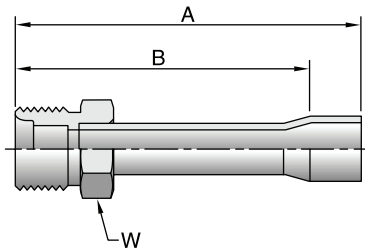

# Part Number	Thread		A		W	B	
	inch	inch	inch	mm	inch	inch	mm
14GZ-6-6	3/8	5/8 - 18	4.0	101.6	5/8	3.62	92.0
14GZ-8-8	1/2	3/4 - 16	4.0	101.6	3/4	3.62	92.0
14GZ-10-10	5/8	7/8 - 14	4.0	101.6	7/8	3.62	92.0

**WARNING:** This product can expose you to chemicals including Lead, which is known to the State of California to cause cancer and birth defects or other reproductive harm. For more information go to [www.p65warnings.ca.gov](http://www.p65warnings.ca.gov).

## 5SGZ Female Tube-O - Swivel - Short Pilot

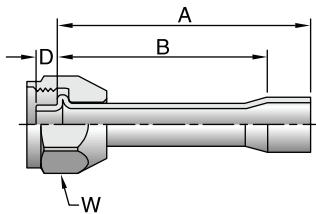

# Part Number	Thread		A		D		W	B	
	inch	inch	inch	mm	inch	mm	inch	inch	mm
5SGZ-6-6	3/8	5/8 - 18	4.0	101.6	0.18	4.7	3/4	3.62	92.0
5SGZ-8-8	1/2	3/4 - 16	4.0	101.6	0.18	4.7	7/8	3.62	92.0
5SGZ-10-10	5/8	7/8 - 14	4.0	101.6	0.18	4.7	1 1/16	3.62	92.0

**WARNING:** This product can expose you to chemicals including Lead, which is known to the State of California to cause cancer and birth defects or other reproductive harm. For more information go to [www.p65warnings.ca.gov](http://www.p65warnings.ca.gov).

## S5GZ Male Tube-O - Swivel - Short Pilot

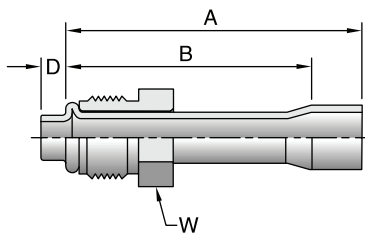

# Part Number	Thread		A		D		W	B	
	inch	inch	inch	mm	inch	mm	inch	inch	mm
S5GZ-6-6	3/8	5/8 - 18	4.0	101.6	0.18	4.7	5/8	3.62	92.0
S5GZ-8-8	1/2	3/4 - 18	4.0	101.6	0.18	4.7	3/4	3.62	92.0
S5GZ-10-10	5/8	7/8 - 18	4.0	101.6	0.18	4.7	7/8	3.62	92.0

**WARNING:** This product can expose you to chemicals including Lead, which is known to the State of California to cause cancer and birth defects or other reproductive harm. For more information go to [www.p65warnings.ca.gov](http://www.p65warnings.ca.gov).

## ZJGZ

### Male "C" Plate Seal / O-ring Block

# Part Number	A		R		B	
	inch	mm	inch	mm	inch	mm
ZJGZ-8-8	4.0	101.6	0.606	15.4	3.62	92.0

**WARNING:** This product can expose you to chemicals including Lead, which is known to the State of California to cause cancer and birth defects or other reproductive harm. For more information go to [www.p65warnings.ca.gov](http://www.p65warnings.ca.gov).

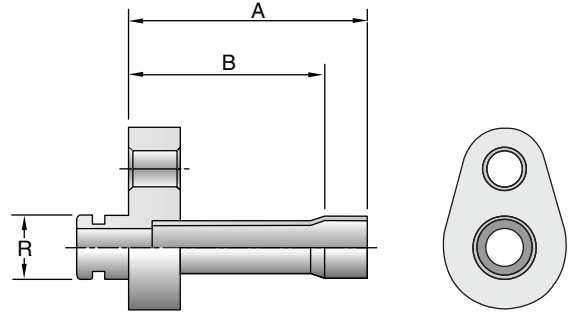

## ZKGZ

### Male Encapsulated Slimline Seal Block

# Part Number	A		R		B	
	inch	mm	inch	mm	inch	mm
ZKGZ-8-8	4.0	101.6	0.459	11.65	3.62	92.0

**WARNING:** This product can expose you to chemicals including Lead, which is known to the State of California to cause cancer and birth defects or other reproductive harm. For more information go to [www.p65warnings.ca.gov](http://www.p65warnings.ca.gov).

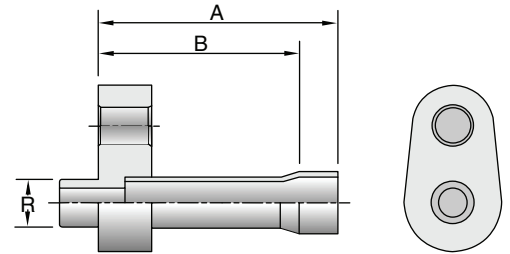

## 1ZG26

### Tube with 26 Series Coupling

# Part Number	Hose I.D.		A		D		B	
	inch	mm	inch	mm	inch	mm	inch	mm
1ZG26-6-6	5/16	-6	25.8	654	3/8	9.5	24	609
1ZG26-8-8	13/32	-8	25.8	654	1/2	12.7	24	609
1ZG26-10-10	1/2	-10	25.8	654	5/8	15.9	24	609

**WARNING:** This product can expose you to chemicals including Lead, which is known to the State of California to cause cancer and birth defects or other reproductive harm. For more information go to [www.p65warnings.ca.gov](http://www.p65warnings.ca.gov).

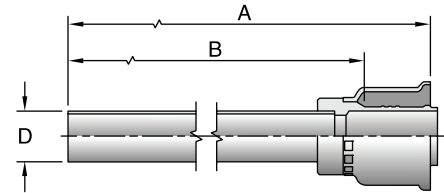

## 1ZG26-PB

### Tube with High Pressure Charge Port

# Part Number	Hose I.D.		A		D		Charge Port	B	
	inch	mm	inch	mm	inch	mm		inch	mm
1ZG26-6-6-PB	5/16	-6	25.8	654	3/8	9.5	368014	24	609

**WARNING:** This product can expose you to chemicals including Lead, which is known to the State of California to cause cancer and birth defects or other reproductive harm. For more information go to [www.p65warnings.ca.gov](http://www.p65warnings.ca.gov).

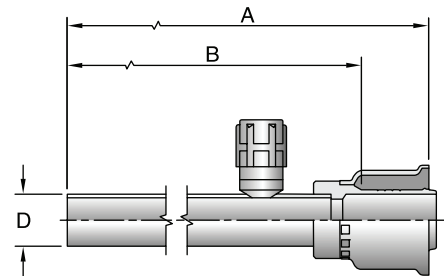

## 1ZG26-PT

### Tube with Low Pressure Charge Port

# Part Number	Hose I.D.		A		D		Charge Port	B	
	inch	mm	inch	mm	inch	mm		inch	mm
1ZG26-10-10-PT	1/2	-10	25.8	654	5/8	15.9	737826	24	609

**WARNING:** This product can expose you to chemicals including Lead, which is known to the State of California to cause cancer and birth defects or other reproductive harm. For more information go to [www.p65warnings.ca.gov](http://www.p65warnings.ca.gov).

## Instructions for Custom Hose Assembly Repairs

Learn how to select the appropriate fittings and couplings to properly prepare tube and hose assemblies that meet SAE J2064 requirements below.



### 1. FITTING SELECTION

The first thing to determine when making a custom hose tube assembly are the fittings to use. Utilizing both tube couplings and hose fittings will give you the ability to make your own custom hose assembly that can be bent to fit a variety of applications.

### 2. TUBE PREPARATION

Next you will need to cut the tube end to achieve the desired length using a Parker Kloskut or similar tubing cutter. Many times, an assembly will only be repaired due to a quality issue with the fitting and doesn't require a complete replacement. In those circumstances, simply cut the tube in a location that enables you to easily replace that particular fitting. Kloskut tube cutters feature a hardened and burnished tool-steel cutting wheel, flare cut-off grooves in rollers for removal of old flares and a swing-away reamer for removing internal burrs.

### 3. BRAZING

The third step in the assembly process is to braze both the tube coupling and hose fitting shell to each end of the tube.

### 4. CLEANING

After the brazed area has been cleaned and dried, it is recommended that the brazed area be spray painted to prevent rust from forming in the area where the plating on the parts was removed during the brazing process. After you've brazed the assembly, you have to clean it. To make cleaning easier, add braze cleaner to the hot water. This sudden cooling cracks the braze flux residue, making it easier to remove. Any remaining residue can be removed by careful wire brushing. Braze cleaner does not provide corrosion protection.

### 5. CORROSION PROTECTION

This is an extremely important step following brazing and even more so following the use of a braze cleaner. The residue left on the surface by the cleaner, especially on the I.D. of the tube, can cause rusting in carbon steel tubes rather quickly if it is not neutralized. Therefore, it is important to neutralize the cleaner residue after cleaning with a solution such as Bernite 1362 (mix 4 ounces of Bernite 136 with one gallon of water).

### 6. PAINTING

After the brazed area has been cleaned and dried, it is recommended that the brazed area be spray painted to prevent rust from forming in the area where the plating on the parts was removed during the brazing process.

### 7. BENDING TUBE END











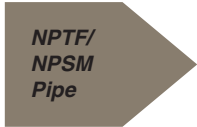
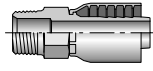
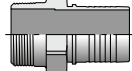
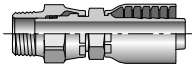
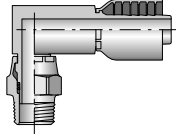
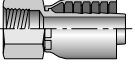
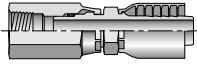
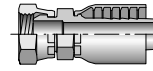

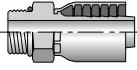
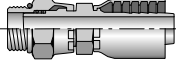
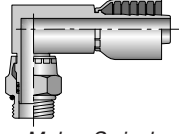
The tube ends can be custom cut and bent after brazing.

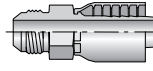
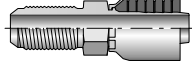
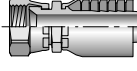
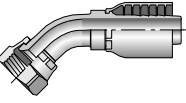
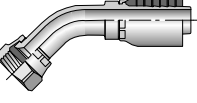
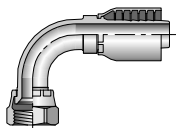
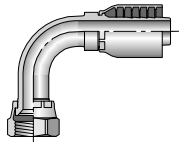
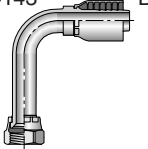
### 8. HOSE SELECTION

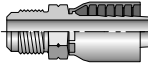
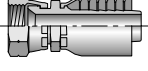
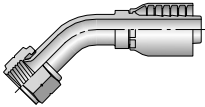
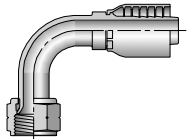
The last step in the process is choosing the proper hose to be attached to the newly created tube assembly. Parker's 285 hose is designed specifically for the rigorous requirements automotive, mobile, bus and transit applications. This air conditioning hose has a long service life, resists moisture ingress and minimizes refrigerant permeation due to a nylon barrier. Our 285 hose is Parkrimp compatible and is available in from -4 to -12 sizes. Hoses should be cut to desired length using Parker's cut-off tool prior to crimping.

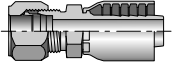
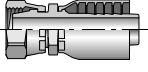
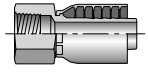
### 9. HOSE CRIMPING

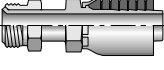
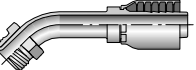
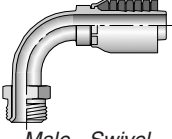
To properly attach 26 series fittings to Parker's 285 hose, please reference CrimpSource for crimping instructions. CrimpSource is Parker's exclusive online software application that supplies you with the necessary crimp specifications in order to adhere to our strict safety standards. You can access CrimpSource by visiting [www.parker.com/crimpsource](http://www.parker.com/crimpsource)

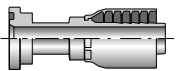
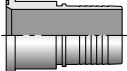
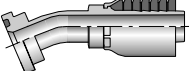
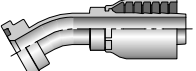
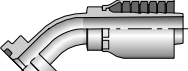
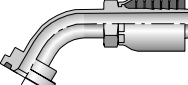
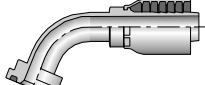
	10143 B-30  Male - Rigid	0143 B-30  Flange Head	11343 B-31  Male - Swivel	11L43 B-31  Male - Swivel 90° Elbow	10243 B-32  Female - Rigid
1S243 B-32  Female - Swivel	10743 B-32  Female - Swivel		10543 B-33  Male - Rigid	10G43 B-33  Male - Swivel	10L43 B-34  Male - Swivel 90° Elbow
	10343 B-34  Male - Rigid	1LB43 B-35  Male - Bulkhead	10643 B-35  Female - Swivel	13743 B-36  Female - Swivel 45° Elbow - Short	1L743 B-36  Female - Swivel 45° Elbow - Medium
13943 B-37  Female - Swivel 90° Elbow - Short	1L943 B-37  Female - Swivel 90° Elbow - Medium	14143 B-38  Female - Swivel 90° Elbow - Long		10443 B-38  Male - Rigid	10843 B-38  Female - Swivel
17743 B-39  Female - Swivel 45° Elbow	17943 B-39  Female - Swivel 90° Elbow		11143 B-39  Male - Rigid	11243 B-40  Female - Swivel	1GJ43 B-40  Female - Rigid
	12843 B-40  Male - Swivel	16743 B-40  Male - Swivel 45° Elbow	16943 B-41  Male - Swivel 90° Elbow		11543 B-41  Flange Head
1543 B-41  Flange Head	11643 B-42  22-1/2° Elbow	12643 B-42  30° Elbow	11743 B-42  45° Elbow	12743 B-43  60° Elbow	11843 B-43  67-1/2° Elbow











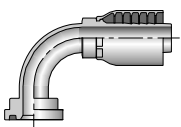

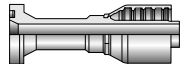
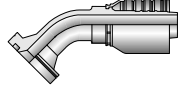
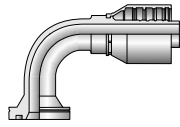
A

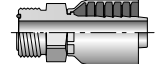
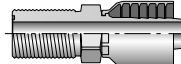
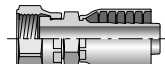
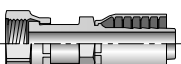
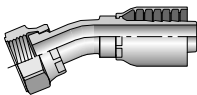
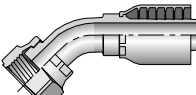
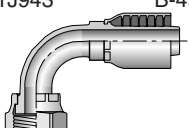
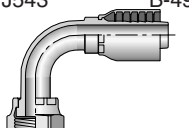
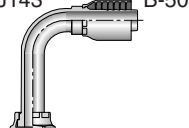
B

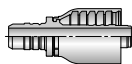
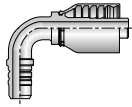
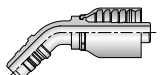

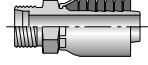
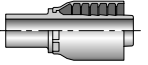
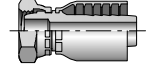
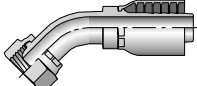
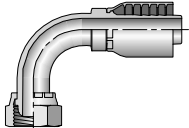
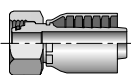
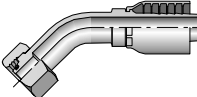
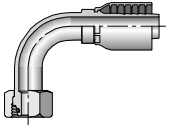

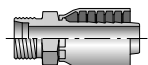
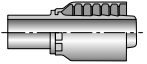
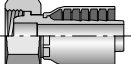
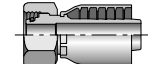
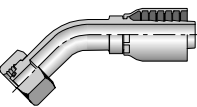
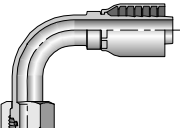
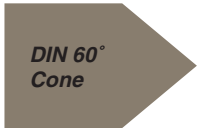
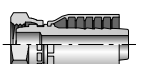

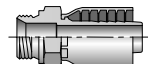
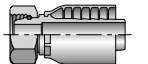
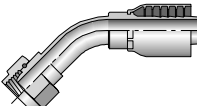
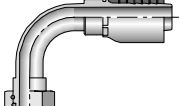
C

D

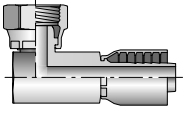
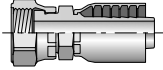
E

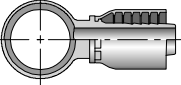
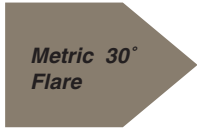
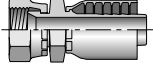
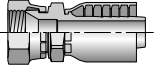
11943 B-43  90° Elbow	 Code 62 Flange	16A43 B-44  Flange Head	16F43 B-44  45° Elbow	16N43 B-44  90° Elbow	 Seal-Lok® (O-Ring Face Seal)
1J043 B-45  Male - Rigid w/O-Ring	1JB43 B-45  Male - Bulkhead w/O-Ring	1JC43 B-46  Female - Swivel Short	1JS43 B-47  Female - Swivel Long	1J643 B-47  Female - Swivel 22-1/2° Elbow	1J743 B-48  Female - Swivel 45° Elbow
1J943 B-49  Female - Swivel 90° Elbow - Short	1J543 B-49  Female - Swivel 90° Elbow - Medium	1J143 B-50  Female - Swivel 90° Elbow - Long	 UPTC	1EN43 B-52  Male	1ET43 B-52  Male 90° Elbow
1EU43 B-52  Male 45° Elbow	 DIN "L" Series & DIN "L" w/O-Ring	1D043 B-53  Male - Rigid	11D43 B-53  Male Standpipe Rigid	1C343 B-54  Female - Swivel	1C443 B-54  Female - Swivel 45° Elbow
1C543 B-54  Female - Swivel 90° Elbow	1CA43 B-55  Female - Swivel	1CE43 B-55  Female - Swivel 45° Elbow	1CF43 B-56  Female - Swivel 90° Elbow	 DIN "S" Series & DIN "S" w/O-Ring	1D243 B-56  Male - Rigid
13D43 B-57  Male Standpipe Rigid	1C643 B-57  Female - Swivel	1C943 B-58  Female - Swivel	10C43 B-59  Female - Swivel 45° Elbow	11C43 B-59  Female - Swivel 90° Elbow	 DIN 60° Cone
1C043 B-58  Female - Swivel	 BSP	1D943 B-60  Male - Rigid	19243 B-60  Female - Swivel	1B143 B-61  Female - Swivel 45° Elbow	1B243 B-61  Female - Swivel 90° Elbow

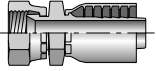
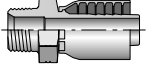
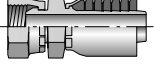

<p>1B443 B-61</p>  <p><i>Female - Swivel 90° Elbow - Block Type</i></p>	<p>1B543 B-62</p>  <p><i>Female - Swivel Flat Seat</i></p>	 <p><i>Banjo</i></p>	<p>14943 B-62</p>  <p><i>Metric Banjo</i></p>	 <p><i>Metric 30° Flare</i></p>	<p>1MU43 B-63</p>  <p><i>Female - Swivel</i></p>
<p>1XU43 B-63</p>  <p><i>Female - Swivel</i></p>	 <p><i>JIS</i></p>	<p>1FU43 B-63</p>  <p><i>Female - Swivel</i></p>	<p>1UT43 B-64</p>  <p><i>Male - Rigid</i></p>	<p>1GU43 B-64</p>  <p><i>Female - Swivel</i></p>	 <p><i>43 Series Crimp Shell</i></p>
<p>B-64</p>  <p><i>43 Series Crimp Shell (for -40 only)</i></p>					



## 10143 Male NPTF Pipe - Rigid

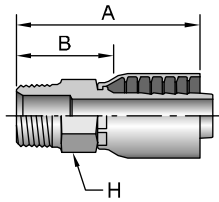

view on web page

Part Number	Thread inch	Hose I.D. inch	A		H inch	B		Additional Material Stainless Steel (C)
			inch	mm		inch	mm	
10143-2-4	1/8x27	1/4	1.80	46	9/16	1.05	27	
10143-4-4	1/4x18	1/4	2.01	51	9/16	1.26	32	•
10143-4-5	1/4x18	5/16	1.94	49	11/16	1.19	30	
10143-4-6	1/4x18	3/8	2.28	58	3/4	1.25	32	
10143-6-4	3/8x18	1/4	1.86	47	11/16	1.11	28	
10143-6-5	3/8x18	5/16	1.94	49	11/16	1.19	30	
10143-6-6	3/8x18	3/8	2.37	60	3/4	1.34	34	•
10143-6-8	3/8x18	1/2	2.59	66	7/8	1.33	34	
10143-6-10	3/8x18	5/8	2.61	66	15/16	1.17	30	
10143-8-4	1/2x14	1/4	2.13	54	7/8	1.38	35	
10143-8-6	1/2x14	3/8	2.39	61	7/8	1.36	35	
10143-8-8	1/2x14	1/2	2.84	72	7/8	1.58	40	•
10143-8-10	1/2x14	5/8	3.04	77	15/16	1.59	40	
10143-8-12	1/2x14	3/4	3.04	77	1-1/16	1.60	41	
10143-12-8	3/4x14	1/2	2.68	68	1-1/16	1.42	36	
10143-12-10	3/4x14	5/8	2.87	73	1-1/16	1.43	36	
10143-12-12	3/4x14	3/4	3.09	78	1-1/16	1.65	42	•
10143-12-16	3/4x14	1	3.40	86	1-3/8	1.78	45	
10143-16-12	1x11-1/2	3/4	3.09	78	1-3/8	1.65	42	
10143-16-16	1x11-1/2	1	3.59	66	1-3/8	1.97	50	•
10143-20-20	1-1/4x11-1/2	1-1/4	4.08	104	1-3/4	2.39	61	•
10143-24-24	1-1/2x11-1/2	1-1/2	3.50	89	2	2.13	54	
10143-32-32	2x11-1/2	2	4.05	103	2-1/2	2.27	58	

Stainless steel fittings must be assembled with Karrykrimp 2, PHastkrimp, Superkrimp or Parkrimp 2. See CrimpSource for more information.

**WARNING:** This product can expose you to chemicals including Lead, which is known to the State of California to cause cancer and birth defects or other reproductive harm. For more information go to [www.p65warnings.ca.gov](http://www.p65warnings.ca.gov).

## 0143 Male NPTF Pipe - Rigid

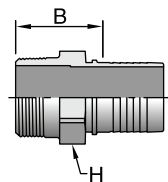

view on web page

# Part Number	Thread inch	Hose I.D. inch	H inch	B	
				inch	mm
0143-40-40	2-1/2x8	2-1/2	3	3.09	78,4
0143-48-48	3x8	3	3-5/8	3.13	79,6

-40 size sold as a two piece fitting. See page B-64 for -40 shell.  
Approved for 187 Hose only.

**WARNING:** This product can expose you to chemicals including Lead, which is known to the State of California to cause cancer and birth defects or other reproductive harm. For more information go to [www.p65warnings.ca.gov](http://www.p65warnings.ca.gov).

# 11343

## Male NPTF Pipe - Swivel

# Part Number	Thread inch	Hose I.D. inch	A		W inch	B	
			inch	mm		inch	mm
11343-2-4	1/8x27	1/4	2.94	75	5/8	2.19	56
11343-4-4	1/4x18	1/4	2.68	68	5/8	1.93	49
11343-4-6	1/4x18	3/8	3.01	76	5/8	1.98	50
11343-6-4	3/8x18	1/4	2.81	71	3/4	2.06	52
11343-6-6	3/8x18	3/8	3.08	78	3/4	2.05	52
11343-6-8	3/8x18	1/2	3.30	84	3/4	2.04	52
11343-8-6	1/2x14	3/8	3.30	84	7/8	2.27	58
11343-8-8	1/2x14	1/2	3.52	89	7/8	2.26	57
11343-12-12	3/4x14	3/4	3.93	100	1-1/4	2.49	63
11343-16-16	1x11-1/2	1	4.52	115	1-1/2	2.90	74

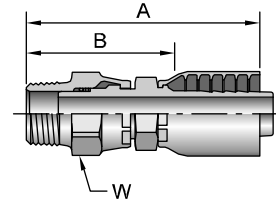

view on web page

O-Ring not compatible with Phosphate Ester fluids.

Fitting allows minor movement under pressure to relieve stress on hose but is not to be used on continuous or extensive swiveling.

**WARNING:** This product can expose you to chemicals including Lead, which is known to the State of California to cause cancer and birth defects or other reproductive harm. For more information go to [www.p65warnings.ca.gov](http://www.p65warnings.ca.gov).

# 11L43

## Male NPTF Pipe - Swivel - 90° Elbow

# Part Number	Thread inch	Hose I.D. inch	A		E		W inch	B	
			inch	mm	inch	mm		inch	mm
11L43-4-4	1/4x18	1/4	2.23	57	1.79	45	5/8	1.48	38
11L43-4-6	1/4x18	3/8	2.53	64	1.85	47	5/8	1.50	38
11L43-6-6	3/8x18	3/8	2.53	64	1.94	49	3/4	1.50	38
11L43-8-6	1/2x14	3/8	2.66	68	2.17	55	7/8	1.63	41
11L43-8-8	1/2x14	1/2	2.96	75	2.17	55	7/8	1.70	43
11L43-12-12	3/4x14	3/4	3.32	84	2.46	62	1-1/4	1.88	48

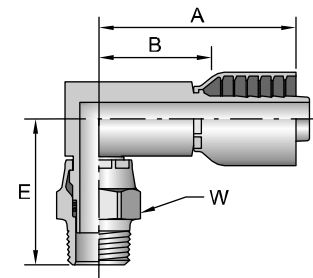

view on web page

O-Ring not compatible with Phosphate Ester fluids.

Fitting allows minor movement under pressure to relieve stress on hose but is not to be used on continuous or extensive swiveling.

**WARNING:** This product can expose you to chemicals including Lead, which is known to the State of California to cause cancer and birth defects or other reproductive harm. For more information go to [www.p65warnings.ca.gov](http://www.p65warnings.ca.gov).

## 10243 Female NPTF Pipe - Rigid

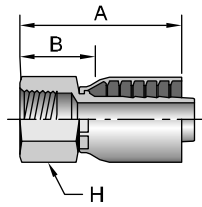

view on web page

# Part Number	Thread inch	Hose I.D. inch	A		H inch	B	
			inch	mm		inch	mm
10243-2-4	1/8x27	1/4	1.68	43	5/8	0.93	24
10243-4-4	1/4x18	1/4	1.78	45	11/16	1.03	26
10243-4-6	1/4x18	3/8	2.05	52	3/4	1.02	26
10243-6-4	3/8x18	1/4	2.05	52	7/8	1.30	33
10243-6-6	3/8x18	3/8	2.32	59	7/8	1.29	33
10243-8-6	1/2x14	3/8	2.40	61	1-1/8	1.37	35
10243-8-8	1/2x14	1/2	2.62	67	1-1/8	1.36	35
10243-12-12	3/4x14	3/4	2.72	69	1-1/4	1.28	33

**WARNING:** This product can expose you to chemicals including Lead, which is known to the State of California to cause cancer and birth defects or other reproductive harm. For more information go to [www.p65warnings.ca.gov](http://www.p65warnings.ca.gov).

## 1S243 Female NPTF Pipe - Swivel

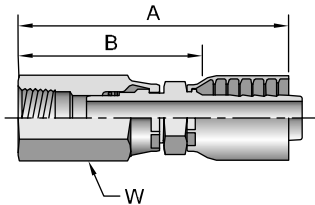

view on web page

# Part Number	Thread inch	Hose I.D. inch	A		W inch	B	
			inch	mm		inch	mm
1S243-4-4	1/4x18	1/4	3.33	85	3/4	2.58	66

**WARNING:** This product can expose you to chemicals including Lead, which is known to the State of California to cause cancer and birth defects or other reproductive harm. For more information go to [www.p65warnings.ca.gov](http://www.p65warnings.ca.gov).

## 10743 Female NPSM Pipe - Swivel - (60° Cone)

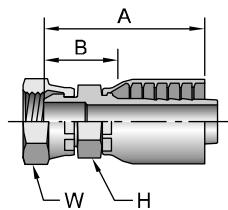

view on web page

# Part Number	Thread inch	Hose I.D. inch	A		H inch	W inch	B	
			inch	mm			inch	mm
10743-2-4	1/8x27	1/4	1.69	43	9/16	9/16	0.94	24
10743-4-4	1/4x18	1/4	1.74	44	9/16	11/16	0.99	25
10743-6-6	3/8x18	3/8	2.09	53	11/16	7/8	1.06	27
10743-8-8	1/2x14	1/2	2.32	59	15/16	1	1.06	27
10743-12-12	3/4x14	3/4	2.70	69	1-1/16	1-1/4	1.47	37
10743-16-16	1x11-1/2	1	3.09	78	1-3/8	1-1/2	1.47	37
10743-20-20	1-1/4x11-1/2	1-1/4	3.28	83	1-7/8	1-7/8	1.59	40

**WARNING:** This product can expose you to chemicals including Lead, which is known to the State of California to cause cancer and birth defects or other reproductive harm. For more information go to [www.p65warnings.ca.gov](http://www.p65warnings.ca.gov).

# 10543

## Male SAE Straight Thread with O-Ring - Rigid

# Part Number	Thread inch		Hose I.D. inch	A		H inch	B	
				inch	mm		inch	mm
10543-4-4	1/4	7/16x20	1/4	1.64	42	9/16	0.89	23
10543-5-4	5/16	1/2x20	1/4	1.80	46	5/8	1.05	27
10543-6-4	3/8	9/16x18	1/4	1.67	42	11/16	0.92	23
10543-6-6	3/8	9/16x18	3/8	2.10	53	11/16	1.07	27
10543-6-8	3/8	9/16x18	1/2	2.32	59	13/16	1.06	27
10543-8-6	1/2	3/4x16	3/8	2.11	54	7/8	1.08	27
10543-8-8	1/2	3/4x16	1/2	2.46	62	7/8	1.20	30
10543-8-10	1/2	3/4x16	5/8	2.63	67	1	1.19	30
10543-10-6	5/8	7/8x14	3/8	2.13	54	1	1.10	28
10543-10-8	5/8	7/8x14	1/2	2.35	60	1	1.09	28
10543-10-10	5/8	7/8x14	5/8	2.77	70	1	1.33	34
10543-12-8	3/4	1-1/16x12	1/2	2.61	66	1-1/4	1.35	34
10543-12-10	3/4	1-1/16x12	5/8	2.80	71	1-1/4	1.36	35
10543-12-12	3/4	1-1/16x12	3/4	2.81	71	1-1/4	1.37	35
10543-16-12	1	1-5/16x12	3/4	2.81	71	1-1/2	1.37	35
10543-16-16	1	1-5/16x12	1	3.37	86	1-1/2	1.75	44
10543-20-20	1-1/4	1-5/8x12	1-1/4	3.69	94	1-7/8	2.00	51

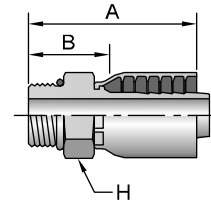

view on web page

**WARNING:** This product can expose you to chemicals including Lead, which is known to the State of California to cause cancer and birth defects or other reproductive harm. For more information go to [www.p65warnings.ca.gov](http://www.p65warnings.ca.gov).

# 10G43

## Male SAE Straight Thread with O-Ring - Swivel

# Part Number	Thread inch		Hose I.D. inch	A		W inch	B	
				inch	mm		inch	mm
10G43-5-4	5/16	1/2x20	1/4	2.98	76	3/4	2.23	57
10G43-6-4	3/8	9/16x18	1/4	2.98	76	3/4	2.23	57
10G43-6-6	3/8	9/16x18	3/8	3.25	83	3/4	2.22	56
10G43-8-6	1/2	3/4x16	3/8	3.06	78	7/8	2.06	52
10G43-8-8	1/2	3/4x16	1/2	3.21	82	7/8	1.95	50
10G43-10-6	5/8	7/8x14	3/8	3.01	76	1	2.01	51
10G43-10-8	5/8	7/8x14	1/2	3.27	83	1	2.01	51
10G43-12-12	3/4	1-1/16x12	3/4	3.78	96	1-1/4	2.34	59

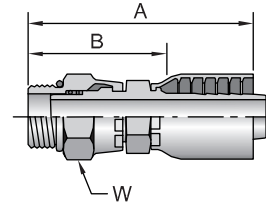

view on web page

O-Ring not compatible with Phosphate Ester fluids.

Fitting allows minor movement under pressure to relieve stress on hose but is not to be used on continuous or extensive swiveling.

**WARNING:** This product can expose you to chemicals including Lead, which is known to the State of California to cause cancer and birth defects or other reproductive harm. For more information go to [www.p65warnings.ca.gov](http://www.p65warnings.ca.gov).

# 10L43

## Male SAE Straight Thread with O-Ring - Swivel - 90° Elbow

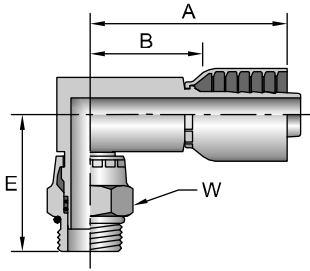

view on web page

# Part Number	Thread		Hose I.D.	A		E		W	B	
	inch	inch		inch	mm	inch	mm		inch	mm
10L43-6-6	3/8	9/16x18	3/8	2.53	64	2.10	53	3/4	1.50	38
10L43-8-6	1/2	3/4x16	3/8	2.66	68	1.86	47	7/8	1.63	41
10L43-8-8	1/2	3/4x16	1/2	2.96	75	1.87	47	7/8	1.70	43
10L43-10-8	5/8	7/8x14	1/2	2.96	75	1.92	49	1	1.70	43
10L43-12-12	3/4	1-1/16x12	3/4	3.22	82	2.30	58	1-1/4	1.88	48

O-Ring not compatible with Phosphate Ester fluids.

See Technical Section for pressure limitations.

Fitting allows minor movement under pressure to relieve stress on hose but is not to be used on continuous or extensive swiveling.

**WARNING:** This product can expose you to chemicals including Lead, which is known to the State of California to cause cancer and birth defects or other reproductive harm. For more information go to [www.p65warnings.ca.gov](http://www.p65warnings.ca.gov).

# 10343

## Male JIC 37° - Rigid

ISO 12151-5

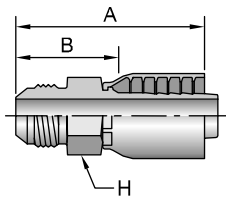

view on web page

# Part Number	Thread		Hose I.D.	A		H	B	
	inch	inch		inch	mm		inch	mm
10343-4-4	1/4	7/16x20	1/4	1.99	51	9/16	1.24	31
10343-5-4	5/16	1/2x20	1/4	1.83	46	9/16	1.08	27
10343-5-6	5/16	1/2x20	3/8	2.26	57	3/4	1.23	31
10343-6-4	3/8	9/16x18	1/4	1.84	47	11/16	1.09	28
10343-6-6	3/8	9/16x18	3/8	2.36	60	3/4	1.33	34
10343-8-6	1/2	3/4x16	3/8	2.30	58	7/8	1.27	32
10343-8-8	1/2	3/4x16	1/2	2.68	68	7/8	1.42	36
10343-8-10	1/2	3/4x16	5/8	2.85	72	7/8	1.41	36
10343-10-6	5/8	7/8x14	3/8	2.40	61	15/16	1.37	35
10343-10-8	5/8	7/8x14	1/2	2.62	67	15/16	1.36	35
10343-10-10	5/8	7/8x14	5/8	3.03	77	15/16	1.59	40
10343-12-8	3/4	1-1/16x12	1/2	2.76	70	1-1/8	1.50	38
10343-12-10	3/4	1-1/16x12	5/8	3.07	78	1-1/8	1.63	41
10343-12-12	3/4	1-1/16x12	3/4	3.19	81	1-1/8	1.75	44
10343-14-12	7/8	1-3/16x12	3/4	3.11	79	1-1/4	1.67	42
10343-16-12	1	1-5/16x12	3/4	3.04	77	1-3/8	1.60	41
10343-16-16	1	1-5/16x12	1	3.63	92	1-3/8	2.01	51
10343-20-20	1-1/4	1-5/8x12	1-1/4	3.96	101	1-7/8	2.27	58
10343-24-20	1-1/2	1-7/8x12	1-1/4	3.71	94	2	2.02	51

**WARNING:** This product can expose you to chemicals including Lead, which is known to the State of California to cause cancer and birth defects or other reproductive harm. For more information go to [www.p65warnings.ca.gov](http://www.p65warnings.ca.gov).

# 1LB43

## Male JIC 37° - Bulkhead without Locknut

# Part Number	Thread		Hose I.D. inch	A		H inch	B	
	inch	mm		inch	mm		inch	mm
1LB43-4-4	1/4	7/16x20	1/4	2.64	67	9/16	1.89	48
1LB43-6-6	3/8	9/16x18	3/8	3.08	78	3/4	2.05	52
1LB43-8-8	1/2	3/4x16	1/2	3.46	88	7/8	2.20	56

Fittings are stocked less locknut (part no. WLN). Locknuts are manufactured by the Parker Tube Fittings Division and must be ordered separately.

**WARNING:** This product can expose you to chemicals including Lead, which is known to the State of California to cause cancer and birth defects or other reproductive harm. For more information go to [www.p65warnings.ca.gov](http://www.p65warnings.ca.gov).

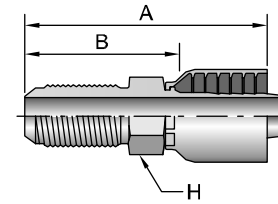

view on web page

# 10643

## Female JIC 37° - Swivel

ISO 12151-5

# Part Number	Thread		Hose I.D. inch	A		H inch	W inch	B		Additional Material Stainless Steel (C)
	inch	mm		inch	mm	inch	inch	inch	mm	
10643-4-4	1/4	7/16x20	1/4	1.94	49,0	9/16	9/16	1.19	30,0	•
10643-4-6	1/4	7/16x20	3/8	2.20	56,0	11/16	9/16	1.17	30,0	
10643-5-4	5/16	1/2x20	1/4	2.03	52,0	9/16	5/8	1.28	33,0	
10643-5-5	5/16	1/2x20	5/16	2.08	53,0	11/16	5/8	1.33	34,0	
10643-5-6	5/16	1/2x20	3/8	2.26	57,0	11/16	5/8	1.23	31,0	
10643-6-4	3/8	9/16x18	1/4	2.05	52,0	9/16	11/16	1.30	33,0	
10643-6-5	3/8	9/16x18	5/16	2.10	53,0	11/16	11/16	1.35	34,0	
10643-6-6	3/8	9/16x18	3/8	2.29	58,0	11/16	11/16	1.26	32,0	•
10643-6-8	3/8	9/16x18	1/2	2.51	64,0	13/16	11/16	1.25	32,0	
10643-8-6	1/2	3/4x16	3/8	2.49	63,0	11/16	7/8	1.46	37,0	•
10643-8-8	1/2	3/4x16	1/2	2.77	67,0	13/16	7/8	1.51	35,0	•
10643-8-10	1/2	3/4x16	5/8	2.82	72,0	15/16	7/8	1.38	35,0	
10643-8-12	1/2	3/4x16	3/4	2.83	72,0	1-1/16	7/8	1.39	35,0	
10643-10-6	5/8	7/8x14	3/8	2.51	64,0	7/8	1	1.48	38,0	
10643-10-8	5/8	7/8x14	1/2	2.85	72,0	7/8	1	1.59	40,0	
10643-10-10	5/8	7/8x14	5/8	2.93	74,0	15/16	1	1.49	38,0	•
10643-10-12	5/8	7/8x14	3/4	2.93	74,0	1-1/16	1	1.49	38,0	
10643-12-8	3/4	1-1/16x12	1/2	2.78	71,0	1-1/16	1-1/4	1.52	39,0	
10643-12-10	3/4	1-1/16x12	5/8	3.10	79,0	1-1/16	1-1/4	1.66	42,0	
10643-12-12	3/4	1-1/16x12	3/4	3.17	81,0	1-1/16	1-1/4	1.73	44,0	•
10643-12-16	3/4	1-1/16x12	1	3.29	84,0	1-3/8	1-1/4	1.67	42,0	
10643-14-12	7/8	1-3/16x12	3/4	3.18	81,0	1-1/4	1-3/8	1.74	44,0	
10643-16-12	1	1-5/16x12	3/4	3.31	84,0	1-1/4	1-1/2	1.87	47,0	
10643-16-16	1	1-5/16x12	1	3.88	98,6	1-3/8	1-1/2	2.26	57,5	•
10643-20-16	1-1/4	1-5/8x12	1	3.81	97,0	1-5/8	2	2.19	56,0	
10643-20-20	1-1/4	1-5/8x12	1-1/4	3.94	100,0	1-7/8	2	2.25	57,0	•
10643-24-24	1-1/2	1-7/8x12	1-1/2	3.84	98,0	2-1/8	2-1/4	2.47	63,0	
10643-32-32	2	2-1/2x12	2	4.73	120,0	2-1/2	2-7/8	2.95	75,0	

Stainless steel fittings must be assembled with Karrykrimp 2, PHastkrimp, Superkrimp or Parkrimp 2. See CrimpSource for more information.

**WARNING:** This product can expose you to chemicals including Lead, which is known to the State of California to cause cancer and birth defects or other reproductive harm. For more information go to [www.p65warnings.ca.gov](http://www.p65warnings.ca.gov).

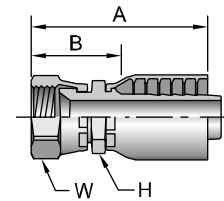

view on web page

# 13743

## Female JIC 37° - Swivel - 45° Elbow - Short Drop ISO 12151-5

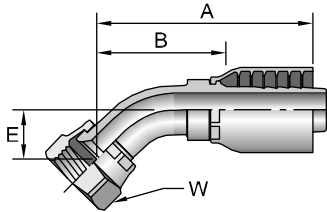

view on web page

# Part Number	Thread		Hose I.D. inch	A		E		W inch	B	
	inch	mm		inch	mm	inch	mm		inch	mm
13743-4-4	1/4	7/16x20	1/4	1.96	50.0	0.39	10	9/16	1.21	31.0
13743-5-4	5/16	1/2x20	1/4	2.19	56.0	0.39	10	5/8	1.26	37.0
13743-6-4	3/8	9/16x18	1/4	2.23	57.0	0.39	10	11/16	1.48	38.0
13743-6-6	3/8	9/16x18	3/8	2.76	70.0	0.39	10	11/16	1.73	43.9
13743-8-6	1/2	3/4x16	3/8	2.74	70.0	0.55	14	7/8	1.74	44.0
13743-8-8	1/2	3/4x16	1/2	3.20	81.2	0.55	14	7/8	1.94	49.3
13743-10-8	5/8	7/8x14	1/2	2.93	74.0	0.63	16	1	1.67	42.0
13743-10-10	5/8	7/8x14	5/8	3.17	81.0	0.63	16	1	1.73	44.0
13743-12-10	3/4	1-1/16x12	5/8	3.62	92.0	0.83	21	1-1/4	2.08	53.0
13743-12-12	3/4	1-1/16x12	3/4	3.63	92.0	0.78	20	1-1/4	2.19	56.0
13743-16-16	1	1-5/16x12	1	4.34	110.0	0.95	24	1-1/2	2.72	69.0
13743-20-20	1-1/4	1-5/8x12	1-1/4	4.59	117.0	1.19	30	2	2.82	72.0
13743-24-24	1-1/2	1-7/8x12	1-1/2	5.50	140.0	1.47	37	2-1/4	4.18	106.0

**WARNING:** This product can expose you to chemicals including Lead, which is known to the State of California to cause cancer and birth defects or other reproductive harm. For more information go to [www.p65warnings.ca.gov](http://www.p65warnings.ca.gov).

# 1L743

## Female JIC 37° - Swivel - 45° Elbow - Medium Drop ISO 12151-5

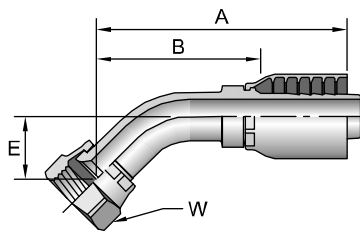

view on web page

# Part Number	Thread		Hose I.D. inch	A		E		W inch	B	
	inch	mm		inch	mm	inch	mm		inch	mm
1L743-6-6	3/8	9/16x18	3/8	2.66	62	0.59	15	11/16	1.63	41
1L743-8-8	1/2	3/4x16	1/2	3.17	80	0.72	18	7/8	1.91	49
1L743-12-12	3/4	1-1/16x12	3/4	4.23	107	1.06	27	1-1/4	2.79	71
1L743-16-16	1	1-5/16x12	1	4.51	115	1.07	27	1-1/2	2.89	73

**WARNING:** This product can expose you to chemicals including Lead, which is known to the State of California to cause cancer and birth defects or other reproductive harm. For more information go to [www.p65warnings.ca.gov](http://www.p65warnings.ca.gov).



# 13943

## Female JIC 37° - Swivel - 90° Elbow - Short Drop ISO 12151-5

# Part Number	Thread inch	Hose I.D. inch	A		E		W inch	B		
			inch	mm	inch	mm		inch	mm	
13943-4-4	1/4	7/16x20	1/4	1.78	45	0.83	21	9/16	1.03	26
13943-4-6	1/4	7/16x20	3/8	2.11	54	0.83	21	9/16	1.08	27
13943-5-4	5/16	1/2x20	1/4	1.88	48	0.83	21	5/8	1.13	29
13943-5-5	5/16	1/2x20	5/16	1.96	50	0.83	21	5/8	1.21	31
13943-6-4	3/8	9/16x18	1/4	2.12	54	0.85	22	11/16	1.37	35
13943-6-6	3/8	9/16x18	3/8	2.21	56	0.91	23	11/16	1.18	30
13943-6-8	3/8	9/16x18	1/2	2.51	64	0.85	22	11/16	1.25	32
13943-8-6	1/2	3/4x16	3/8	2.52	64	1.09	28	7/8	1.49	38
13943-8-8	1/2	3/4x16	1/2	2.62	67	1.14	29	7/8	1.36	35
13943-10-8	5/8	7/8x14	1/2	2.74	70	1.26	32	1	1.48	38
13943-10-10	5/8	7/8x14	5/8	2.97	75	1.26	32	1	1.69	39
13943-12-8	3/4	1-1/16x12	1/2	3.25	83	1.83	46	1-1/4	1.99	51
13943-12-10	3/4	1-1/16x12	5/8	3.07	78	1.89	48	1-1/4	1.63	41
13943-12-12	3/4	1-1/16x12	3/4	3.49	89	1.89	48	1-1/4	2.05	52
13943-16-12	1	1-5/16x12	3/4	3.49	89	2.00	51	1-1/2	2.05	52
13943-16-16	1	1-5/16x12	1	4.28	109	2.20	56	1-1/2	2.66	68
13943-20-20	1-1/4	1-5/8x12	1-1/4	4.43	113	2.59	66	2	2.74	70
13943-24-24	1-1/2	1-7/8x12	1-1/2	5.50	140	3.81	81	2-1/4	4.13	105
13943-32-32	2	2-1/2x12	2	6.75	171,4	4.62	117	2-7/8	4.97	126,2

**WARNING:** This product can expose you to chemicals including Lead, which is known to the State of California to cause cancer and birth defects or other reproductive harm. For more information go to [www.p65warnings.ca.gov](http://www.p65warnings.ca.gov).

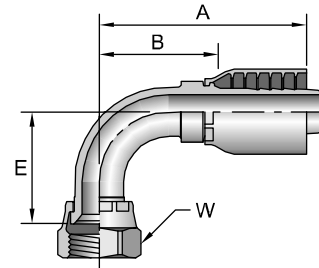

view on web page

# 1L943

## Female JIC 37° - Swivel - 90° Elbow - Medium Drop ISO 12151-5

# Part Number	Thread inch	Hose I.D. inch	A		E		W inch	B		
			inch	mm	inch	mm		inch	mm	
1L943-4-4	1/4	7/16x20	1/4	1.84	47	1.26	32	9/16	1.09	28
1L943-6-4	3/8	9/16x18	1/4	2.12	54	1.50	38	11/16	1.37	35
1L943-6-6	3/8	9/16x18	3/8	2.29	58	1.50	38	11/16	1.26	32
1L943-8-6	1/2	3/4x16	3/8	2.51	64	1.61	41	7/8	1.48	38
1L943-8-8	1/2	3/4x16	1/2	2.64	67	1.61	41	7/8	1.38	35
1L943-10-8	5/8	7/8x14	1/2	3.25	83	1.75	44	1	1.99	51
1L943-12-12	3/4	1-1/16x12	3/4	3.49	89	2.28	58	1-1/4	2.05	52
1L943-16-16	1	1-5/16x12	1	4.44	113	2.50	64	1-1/2	2.82	72

**WARNING:** This product can expose you to chemicals including Lead, which is known to the State of California to cause cancer and birth defects or other reproductive harm. For more information go to [www.p65warnings.ca.gov](http://www.p65warnings.ca.gov).

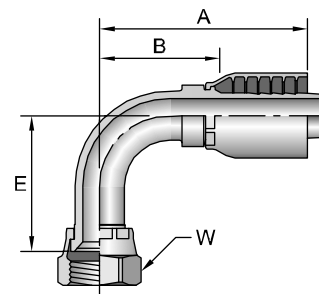

view on web page

# 14143

## Female JIC 37° - Swivel - 90° Elbow - Long Drop ISO 12151-5

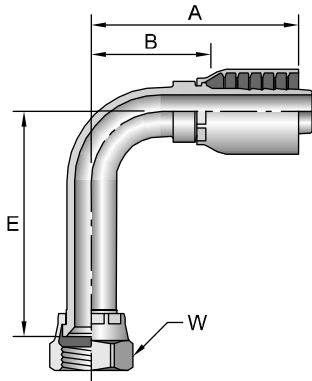

view on web page

# Part Number	Thread		Hose I.D. inch	A		E		W inch	B	
	inch	inch		inch	mm	inch	mm		inch	mm
14143-4-4	1/4	7/16x20	1/4	1.96	50	1.81	46	9/16	1.21	31
14143-5-4	5/16	1/2x20	1/4	1.93	49	1.80	46	5/8	1.18	30
14143-6-6	3/8	9/16x18	3/8	2.27	58	2.18	55	11/16	1.27	32
14143-8-6	1/2	3/4x16	3/8	2.56	65	2.43	62	7/8	1.56	40
14143-8-8	1/2	3/4x16	1/2	2.62	67	2.52	64	7/8	1.36	35
14143-10-8	5/8	7/8x14	1/2	2.78	71	2.58	66	1	1.52	39
14143-10-10	5/8	7/8x14	5/8	3.16	80	2.58	66	1	1.75	44
14143-12-12	3/4	1-1/16x12	3/4	3.49	89	3.74	95	1-1/4	2.05	52
14143-14-12	7/8	1-3/16x12	3/4	3.38	86	3.93	100	1-3/8	1.95	50
14143-16-16	1	1-5/16x12	1	3.90	99	4.32	110	1-1/2	2.31	59
14143-20-20	1-1/4	1-5/8x12	1-1/4	4.39	112	5.28	134	2	2.73	69

**WARNING:** This product can expose you to chemicals including Lead, which is known to the State of California to cause cancer and birth defects or other reproductive harm. For more information go to [www.p65warnings.ca.gov](http://www.p65warnings.ca.gov).

# 10443

## Male SAE 45° - Rigid

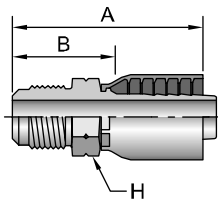

view on web page

# Part Number	Thread		Hose I.D. inch	A		H inch	B	
	inch	inch		inch	mm		inch	mm
10443-6-6	3/8	5/8x18	3/8	2.21	56	3/4	1.21	31
10443-12-12	3/4	1-1/16x14	3/4	3.20	81	1-1/8	1.77	45

**WARNING:** This product can expose you to chemicals including Lead, which is known to the State of California to cause cancer and birth defects or other reproductive harm. For more information go to [www.p65warnings.ca.gov](http://www.p65warnings.ca.gov).

# 10843

## Female SAE 45° - Swivel

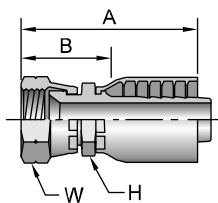

view on web page

# Part Number	Thread		Hose I.D. inch	A		H inch	W inch	B	
	inch	inch		inch	mm			inch	mm
10843-6-4	3/8	5/8x18	1/4	2.11	54	3/4	3/4	1.36	35
10843-6-6	3/8	5/8x18	3/8	2.38	60	3/4	3/4	1.35	34
10843-12-12	3/4	1-1/16x14	3/4	3.17	81	1-1/16	1-1/4	1.73	44

**WARNING:** This product can expose you to chemicals including Lead, which is known to the State of California to cause cancer and birth defects or other reproductive harm. For more information go to [www.p65warnings.ca.gov](http://www.p65warnings.ca.gov).

Notch on nut signifies SAE 45° flare.

# 17743

## Female SAE 45° - Swivel - 45° Elbow

# Part Number	Thread		Hose I.D. inch	A		E		W		B	
	inch	mm		inch	mm	inch	mm	inch	mm	inch	mm
17743-4-6	1/4	7/16x20	3/8	2.28	58	0.33	8	9/16	1.25	32	

**WARNING:** This product can expose you to chemicals including Lead, which is known to the State of California to cause cancer and birth defects or other reproductive harm. For more information go to [www.p65warnings.ca.gov](http://www.p65warnings.ca.gov).

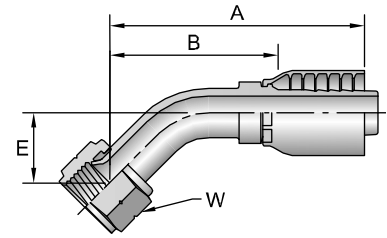

view on web page

# 17943

## Female SAE 45° - Swivel - 90° Elbow

# Part Number	Thread		Hose I.D. inch	A		E		W		B	
	inch	mm		inch	mm	inch	mm	inch	mm	inch	mm
17943-6-6	3/8	5/8x18	3/8	2.13	54	0.85	22	3/4	1.13	29	

**WARNING:** This product can expose you to chemicals including Lead, which is known to the State of California to cause cancer and birth defects or other reproductive harm. For more information go to [www.p65warnings.ca.gov](http://www.p65warnings.ca.gov).

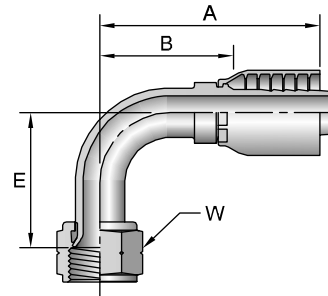

view on web page

# 11143

## Male Ferulok Flareless - Rigid (24° Cone with Nut and Ferrule)

# Part Number	Thread		Hose I.D. inch	A		H	W	B	
	inch	mm		inch	inch	inch	inch	mm	
11143-4-4	1/4	7/16x20	1/4	2.13	54	9/16	9/16	1.40	36
11143-4-6	1/4	7/16x20	3/8	2.44	62	3/4	9/16	1.44	37
11143-5-4	5/16	1/2x20	1/4	2.13	54	9/16	5/8	1.40	36
11143-5-6	5/16	1/2x20	3/8	2.44	62	3/4	5/8	1.44	37
11143-6-6	3/8	9/16x18	3/8	2.50	64	3/4	11/16	1.50	38
11143-8-8	1/2	3/4x16	1/2	2.93	74	7/8	7/8	1.68	43
11143-10-8	5/8	7/8x14	1/2	3.07	78	15/16	1	1.82	46
11143-12-12	3/4	1-1/16x12	3/4	3.39	86	1-1/8	1-1/4	1.96	50
11143-16-16	1	1-5/16x12	1	3.80	97	1-3/8	1-1/2	2.18	55

The Parker Ferrul-Fix fitting makes it possible to salvage the bent tube section from a hose assembly for quick, easy on-the-job repairs. For additional information see Ferrule-Fix installation instructions in the Technical Section.

**WARNING:** This product can expose you to chemicals including Lead, which is known to the State of California to cause cancer and birth defects or other reproductive harm. For more information go to [www.p65warnings.ca.gov](http://www.p65warnings.ca.gov).

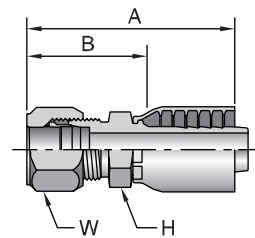

view on web page

Notch on nut signifies SAE 45° flare.

## 11243

### Female Ferulok Flareless - Swivel - (24° Cone)

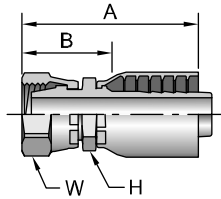

view on web page

# Part Number	Thread		Hose I.D. inch	A		H inch	W inch	B	
	inch	inch		inch	mm			inch	mm
11243-6-6	3/8	9/16x18	3/8	2.51	64	11/16	11/16	1.48	38
11243-8-6	1/2	3/4x16	3/8	2.67	68	7/8	7/8	1.64	42
11243-8-8	1/2	3/4x16	1/2	2.89	73	7/8	7/8	1.63	41

**WARNING:** This product can expose you to chemicals including Lead, which is known to the State of California to cause cancer and birth defects or other reproductive harm. For more information go to [www.p65warnings.ca.gov](http://www.p65warnings.ca.gov).

## 1GJ43

### Female Grease Connection - SPL - PTF Taper Thread Rigid - 1/2 x 27

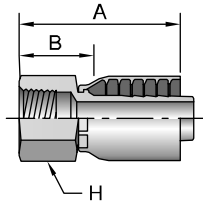

view on web page

# Part Number	Thread		Hose I.D. inch	A		H inch	B	
	inch	inch		inch	mm		inch	mm
1GJ43-4-4	1/2x27		1/4	1.79	45	3/4	1.04	26

**WARNING:** This product can expose you to chemicals including Lead, which is known to the State of California to cause cancer and birth defects or other reproductive harm. For more information go to [www.p65warnings.ca.gov](http://www.p65warnings.ca.gov).

## 12843

### Male Inverted SAE 45° - Swivel

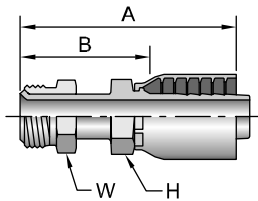

view on web page

# Part Number	Thread		Hose I.D. inch	A		H inch	W inch	B	
	inch	inch		inch	mm			inch	mm
12843-4-4	1/4	7/16x24	1/4	2.32	59	9/16	7/16	1.57	40
12843-4-6	1/4	7/16x24	3/8	2.65	67	11/16	7/16	1.62	41
12843-5-4	5/16	1/2x20	1/4	2.60	66	9/16	1/2	1.85	47
12843-5-6	5/16	1/2x20	3/8	2.74	70	11/16	1/2	1.71	43
12843-6-6	3/8	5/8x18	3/8	2.86	73	11/16	5/8	1.83	46
12843-8-8	1/2	3/4x18	1/2	3.11	79	13/16	3/4	1.85	47
12843-10-10	5/8	7/8x18	5/8	3.55	90	3/4	7/8	2.11	54

**WARNING:** This product can expose you to chemicals including Lead, which is known to the State of California to cause cancer and birth defects or other reproductive harm. For more information go to [www.p65warnings.ca.gov](http://www.p65warnings.ca.gov).

## 16743

### Male Inverted SAE 45° - Swivel - 45° Elbow

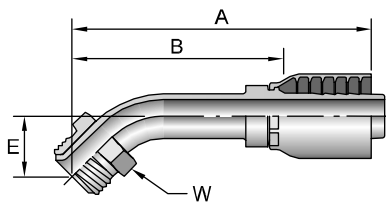

view on web page

# Part Number	Thread		Hose I.D. inch	A		E		W inch	B	
	inch	inch		inch	mm	inch	mm		inch	mm
16743-4-4	1/4	7/16x24	1/4	2.09	53	0.63	16	7/16	1.34	34
16743-5-4	5/16	1/2x20	1/4	2.34	59	0.70	18	1/2	1.59	40
16743-5-6	5/16	1/2x20	3/8	2.48	63	0.70	18	1/2	1.45	37
16743-6-6	3/8	5/8x18	3/8	2.93	74	0.94	24	5/8	1.90	48
16743-8-8	1/2	3/4x18	1/2	3.23	82	1.09	28	3/4	1.97	50

**WARNING:** This product can expose you to chemicals including Lead, which is known to the State of California to cause cancer and birth defects or other reproductive harm. For more information go to [www.p65warnings.ca.gov](http://www.p65warnings.ca.gov).

# 16943

## Male Inverted SAE 45° - Swivel - 90° Elbow

# Part Number	Thread		Hose I.D. inch	A		E		W inch	B	
	inch	mm		inch	mm	inch	mm		inch	mm
16943-4-4	1/4	7/16x24	1/4	2.16	55	1.56	40	7/16	1.41	36
16943-4-6	1/4	7/16x24	3/8	2.49	63	1.56	40	7/16	1.46	37
16943-5-4	5/16	1/2x20	1/4	2.41	61	1.65	42	1/2	1.66	42
16943-5-6	5/16	1/2x20	3/8	2.59	66	1.65	42	1/2	1.56	40
16943-6-6	3/8	5/8x18	3/8	2.61	66	1.69	43	5/8	1.58	40
16943-8-8	1/2	3/4x18	1/2	2.81	71	1.88	48	3/4	1.55	39

**WARNING:** This product can expose you to chemicals including Lead, which is known to the State of California to cause cancer and birth defects or other reproductive harm. For more information go to [www.p65warnings.ca.gov](http://www.p65warnings.ca.gov).

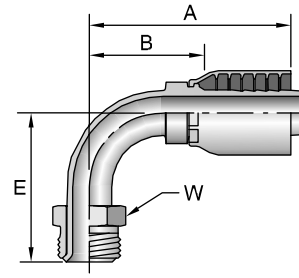

view on web page

# 11543

## SAE Code 61 Flange Head ISO 12151-3 - S - L

# Part Number	Flange inch	Hose I.D. inch	A		F inch	B	
			inch	mm		inch	mm
11543-8-8	1/2	1/2	3.48	88	1-3/16	2.22	56
11543-10-10	5/8	5/8	3.78	96,0	1-11/32	2.34	59,4
11543-12-8	3/4	1/2	2.46	62,5	1-1/2	1.20	30,5
11543-12-12	3/4	3/4	3.54	90	1-1/2	2.42	61,5
11543-16-12	1	3/4	2.74	70	1-3/4	1.30	33
11543-16-16	1	1	4.25	108	1-3/4	2.63	67
11543-20-16	1-1/4	1	3.19	81	2	1.57	40
11543-20-20	1-1/4	1-1/4	4.70	119	2	3.01	76
11543-24-20	1-1/2	1-1/4	3.22	82	2-3/8	1.53	39
11543-24-24	1-1/2	1-1/2	4.59	117	2-3/8	3.22	82
11543-24-32	1-1/2	2	5.65	144	2-7/8	3.87	98
11543-32-20	2	1-1/4	4.29	109	2-13/16	2.60	66
11543-32-24	2	1-1/2	3.14	80	2-7/8	1.77	45
11543-32-32	2	2	4.99	127	2-13/16	3.21	82

**WARNING:** This product can expose you to chemicals including Lead, which is known to the State of California to cause cancer and birth defects or other reproductive harm. For more information go to [www.p65warnings.ca.gov](http://www.p65warnings.ca.gov).

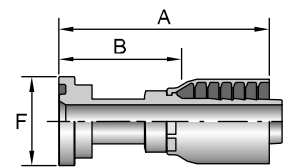

view on web page

# 1543

## SAE Code 61 Flange Head ISO 12151-3 - S - L

# Part Number	Flange inch	Hose I.D. inch	F inch	B	
				inch	mm
1543-40-40	2-1/2x8	2-1/2	3-15/16	2.73	69,2
1543-48-48	3	3	4	3.54	90,0

-40 size sold as a two piece fitting. See page B-64 for -40 shell. Approved for 187 Hose only.

**WARNING:** This product can expose you to chemicals including Lead, which is known to the State of California to cause cancer and birth defects or other reproductive harm. For more information go to [www.p65warnings.ca.gov](http://www.p65warnings.ca.gov).

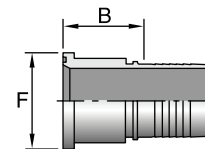

view on web page

See Accessories Section for O-Rings and Flange Kits.

# 11643

## SAE Code 61 Flange Head - 22-1/2° Elbow

ISO 12151-3 - E22M - L

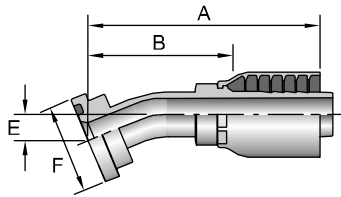

view on web page

# Part Number	Flange inch	Hose I.D. inch	A		E		F inch	B	
			inch	mm	inch	mm		inch	mm
11643-12-12	3/4	3/4	3.90	99	0.44	11	1-1/2	2.47	63
11643-16-12	1	3/4	3.89	99	0.44	11	1-3/4	2.46	62
11643-16-16	1	1	4.25	108	0.44	11	1-3/4	2.66	68
11643-20-16	1-1/4	1	4.25	108	0.44	11	2	2.66	68
11643-20-20	1-1/4	1-1/4	4.65	118	0.50	13	2	3.00	76
11643-24-20	1-1/2	1-1/4	4.66	118	0.51	13	2-3/8	3.01	76

**WARNING:** This product can expose you to chemicals including Lead, which is known to the State of California to cause cancer and birth defects or other reproductive harm. For more information go to [www.p65warnings.ca.gov](http://www.p65warnings.ca.gov).

# 12643

## SAE Code 61 Flange Head - 30° Elbow

ISO 12151-3 - E30S - L (1 Piece: ISO 12151-3 - E30M - L)

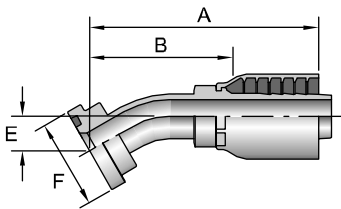

view on web page

# Part Number	Flange inch	Hose I.D. inch	A		E		F inch	B	
			inch	mm	inch	mm		inch	mm
12643-12-12	3/4	3/4	3.90	99	0.59	15	1-1/2	2.46	62
12643-16-16	1	1	4.38	111	0.62	16	1-3/4	2.76	70
12643-20-16	1-1/4	1	4.38	111	0.62	16	2	2.76	70
12643-20-20	1-1/4	1-1/4	4.39	112	0.72	18	2	2.70	69

**WARNING:** This product can expose you to chemicals including Lead, which is known to the State of California to cause cancer and birth defects or other reproductive harm. For more information go to [www.p65warnings.ca.gov](http://www.p65warnings.ca.gov).

# 11743

## SAE Code 61 Flange Head - 45° Elbow

ISO 12151-3 - E45S - L (1 Piece: ISO 12151-3 - E45M - L)

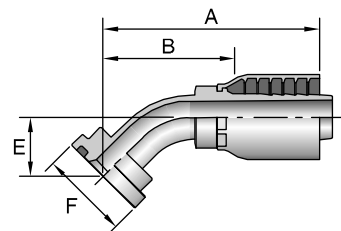

view on web page

# Part Number	Flange inch	Hose I.D. inch	A		E		F inch	B	
			inch	mm	inch	mm		inch	mm
11743-8-8	1/2	1/2	2.99	76	0.75	19	1-3/16	1.73	44
11743-10-10	5/8	5/8	4.63	118	0.94	24	1-11/32	3.19	81
11743-12-8	3/4	1/2	3.30	84	0.87	22	1-1/2	2.04	52
11743-12-12	3/4	3/4	3.85	98	1.02	26	1-1/2	2.41	61
11743-16-12	1	3/4	3.85	98	1.02	26	1-3/4	2.41	61
11743-16-16	1	1	4.76	121	1.26	32	1-3/4	3.14	80
11743-20-16	1-1/4	1	4.76	121	1.26	32	2	3.14	80
11743-20-20	1-1/4	1-1/4	5.61	142	1.50	38	2	3.92	100
11743-20-24	1-1/4	1-1/2	5.45	138	1.38	35	2	4.08	104
11743-24-20	1-1/2	1-1/4	5.55	141	1.50	38	2-3/8	3.86	98
11743-24-24	1-1/2	1-1/2	5.50	140	1.42	36	2-3/8	4.13	105
11743-32-24	2	1-1/2	5.49	139	1.42	36	2-13/16	4.12	105
11743-32-32	2	2	7.67	195	2.21	56	2-13/16	5.89	150

**WARNING:** This product can expose you to chemicals including Lead, which is known to the State of California to cause cancer and birth defects or other reproductive harm. For more information go to [www.p65warnings.ca.gov](http://www.p65warnings.ca.gov).

See Accessories Section for O-Rings and Flange Kits.

# 12743

## SAE Code 61 Flange Head - 60° Elbow

ISO 12151-3 - E60S - L (1 Piece: ISO 12151-3 - E60M - L)

# Part Number	Flange inch	Hose I.D. inch	A		E		F inch	B	
			inch	mm	inch	mm		inch	mm
12743-12-12	3/4	3/4	4.16	105	1.43	36	1-1/2	2.72	69
12743-16-12	1	3/4	4.15	105	1.39	35	1-3/4	2.71	69
12743-16-16	1	1	4.45	113	1.50	38	1-3/4	2.83	72
12743-20-20	1-1/4	1-1/4	5.09	129	1.69	43	2	3.40	86

**WARNING:** This product can expose you to chemicals including Lead, which is known to the State of California to cause cancer and birth defects or other reproductive harm. For more information go to [www.p65warnings.ca.gov](http://www.p65warnings.ca.gov).

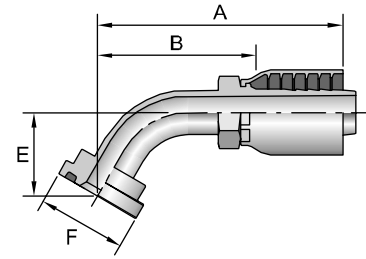

view on web page

# 11843

## SAE Code 61 Flange Head - 67-1/2° Elbow

ISO 12151-3 - E67S - L (1 Piece: ISO 12151-3 - E67M - L)

# Part Number	Flange inch	Hose I.D. inch	A		E		F inch	B	
			inch	mm	inch	mm		inch	mm
11843-12-12	3/4	3/4	4.09	104	1.60	41	1-1/2	2.66	68
11843-16-16	1	1	4.66	118	1.75	44	1-3/4	3.07	78
11843-20-20	1-1/4	1-1/4	5.04	128	1.94	49	2	3.37	86

**WARNING:** This product can expose you to chemicals including Lead, which is known to the State of California to cause cancer and birth defects or other reproductive harm. For more information go to [www.p65warnings.ca.gov](http://www.p65warnings.ca.gov).

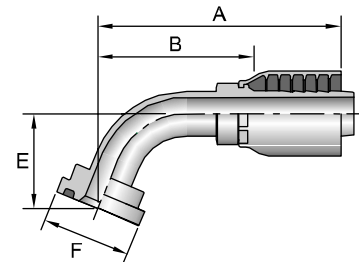

view on web page

# 11943

## SAE Code 61 Flange Head - 90° Elbow

ISO 12151-3 - E90S - L (1 Piece: ISO 12151-3 - E90M - L)

# Part Number	Flange inch	Hose I.D. inch	A		E		F inch	B	
			inch	mm	inch	mm		inch	mm
11943-8-8	1/2	1/2	2.93	74	1.60	41	1-3/16	1.67	42
11943-10-10	5/8	5/8	3.71	94	2.10	53	1-11/32	2.27	58
11943-12-8	3/4	1/2	2.93	74	1.66	42	1-1/2	1.67	42
11943-12-10	3/4	5/8	3.71	94	2.10	53	1-1/2	2.27	58
11943-12-12	3/4	3/4	3.51	89	2.28	58	1-1/2	2.07	53
11943-16-12	1	3/4	3.59	91	2.24	57	1-3/4	2.15	55
11943-16-16	1	1	4.28	109	2.78	71	1-3/4	2.66	68
11943-20-16	1-1/4	1	4.25	108	2.76	70	2	2.63	67
11943-20-20	1-1/4	1-1/4	5.12	130	3.54	90	2	3.43	87
11943-20-24	1-1/4	1-1/2	4.19	106	2.49	63	2	2.82	72
11943-24-20	1-1/2	1-1/4	5.09	129	3.54	90	2-3/8	3.40	86
11943-24-24	1-1/2	1-1/2	5.50	140	4.09	79	2-3/8	4.13	105
11943-32-24	2	1-1/2	5.48	139	3.10	79	2-13/16	4.11	104
11943-32-32	2	2	6.75	171	5.43	114	2-13/16	4.97	126

**WARNING:** This product can expose you to chemicals including Lead, which is known to the State of California to cause cancer and birth defects or other reproductive harm. For more information go to [www.p65warnings.ca.gov](http://www.p65warnings.ca.gov).

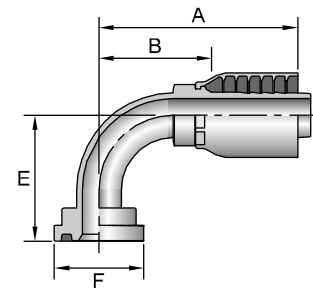

view on web page

See Accessories Section for O-Rings and Flange Kits.

## 16A43

### SAE Code 62 Flange Head

ISO 12151-3 - S - S

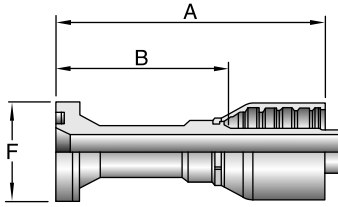

view on web page

# Part Number	Flange inch	Hose I.D. inch	A		B		F	
			inch	mm	inch	mm	inch	mm
16A43-12-12	3/4	3/4	4.12	104,6	2.68	68,0	1-5/8	
16A43-16-12	1	3/4	3.10	78,7	1.66	42,2	1-7/8	
16A43-16-16	1	1	4.81	122,2	3.19	81,0	1-7/8	
16A43-20-16	1-1/4	1	3.61	91,7	1.99	50,5	2-1/8	
16A43-20-20	1-1/4	1-1/4	5.01	127,3	3.32	84,3	2-1/8	

**⚠ WARNING:** This product can expose you to chemicals including Lead, which is known to the State of California to cause cancer and birth defects or other reproductive harm. For more information go to [www.p65warnings.ca.gov](http://www.p65warnings.ca.gov).

## 16F43

### SAE Code 62 Flange Head - 45° Elbow

ISO 12151-3 - E45S - S (1 Piece 12151-3-E45M-S)

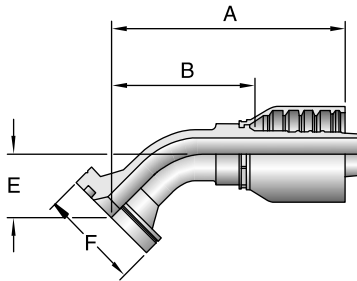

view on web page

# Part Number	Flange inch	Hose I.D. inch	A		B		F		E	
			inch	mm	inch	mm	inch	mm	inch	mm
16F43-12-12	3/4	3/4	3.82	97,0	2.38	60,5	1-5/8	1.02	25,9	
16F43-16-16	1	1	4.66	118,4	3.04	77,2	1-7/8	1.26	32,0	
16F43-20-16	1-1/4	1	4.57	116,1	2.95	74,9	2-1/8	1.06	26,9	

**⚠ WARNING:** This product can expose you to chemicals including Lead, which is known to the State of California to cause cancer and birth defects or other reproductive harm. For more information go to [www.p65warnings.ca.gov](http://www.p65warnings.ca.gov).

## 16N43

### SAE Code 62 Flange Head - 90° Elbow

ISO 12151-3 - E90S - S (1 Piece 12151-3-E90M-S)

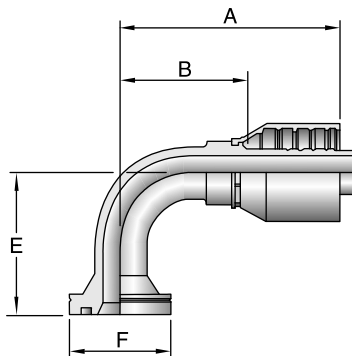

view on web page

# Part Number	Flange inch	Hose I.D. inch	A		B		F		E	
			inch	mm	inch	mm	inch	mm	inch	mm
16N43-12-12	3/4	3/4	3.51	89,2	2.07	52,6	1-5/8	2.28	57,9	
16N43-16-12	1	3/4	3.49	88,6	2.05	52,1	1-7/8	2.28	57,9	
16N43-16-16	1	1	4.28	108,7	2.66	67,6	1-7/8	2.76	70,1	
16N43-20-16	1-1/4	1	4.28	108,7	2.66	67,6	2-1/8	2.76	70,1	
16N43-20-20	1-1/4	1-1/4	5.09	129,3	3.40	86,4	2-1/8	3.54	90,0	

**⚠ WARNING:** This product can expose you to chemicals including Lead, which is known to the State of California to cause cancer and birth defects or other reproductive harm. For more information go to [www.p65warnings.ca.gov](http://www.p65warnings.ca.gov).



# 1J043

## Male Seal-Lok® - Rigid - (with O-Ring)

SAE J516 (Apr2016)

# Part Number	Thread		Hose I.D. inch	A		H inch	B	
	inch	mm		inch	mm		inch	mm
1J043-4-4	1/4	9/16x18	1/4	1.73	44	5/8	0.98	25
1J043-6-6	3/8	11/16x16	3/8	2.08	53	3/4	1.05	27
1J043-8-6	1/2	13/16x16	3/8	2.20	56	7/8	1.17	30
1J043-8-8	1/2	13/16x16	1/2	2.42	61	7/8	1.17	30
1J043-10-8	5/8	1x14	1/2	2.61	66	1-1/16	1.35	34
1J043-10-10	5/8	1x14	5/8	2.73	69	1-1/16	1.34	34
1J043-12-10	3/4	1-3/16x12	5/8	2.89	73	1-1/4	1.45	37
1J043-12-12	3/4	1-3/16x12	3/4	2.90	74	1-1/4	1.46	37
1J043-16-12	1	1-7/16x12	3/4	2.93	74	1-1/2	1.49	38
1J043-16-16	1	1-7/16x12	1	3.29	84	1-1/2	1.67	42
1J043-20-20	1-1/4	1-11/16x12	1-1/4	3.32	84	1-3/4	1.63	41

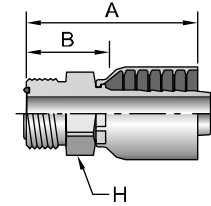

view on web page

Supplied with Parker's exclusive Trap-Seal™, which leads to improved retention within Seal-Lok's™ ORFS groove and virtually eliminates costly leakage and/or time consuming pre-assembly handling.

**WARNING:** This product can expose you to chemicals including Lead, which is known to the State of California to cause cancer and birth defects or other reproductive harm. For more information go to [www.p65warnings.ca.gov](http://www.p65warnings.ca.gov).

# 1JB43

## Male Seal-Lok® - Bulkhead without Locknut - (with O-Ring)

End Connection per SAE J516 (Apr2016)

# Part Number	Thread		Hose I.D. inch	A		H mm	B	
	inch	mm		inch	mm		inch	mm
1JB43-4-4	1/4	9/16x18	1/4	2.67	68	22	1.92	49
1JB43-6-6	3/8	11/16x16	3/8	3.08	78	27	2.05	52
1JB43-8-8	1/2	13/16x16	1/2	3.44	87	30	2.18	55
1JB43-10-8	5/8	1x14	1/2	3.69	94	36	2.43	62
1JB43-10-10	5/8	1x14	5/8	3.88	99	36	2.44	62
1JB43-12-12	3/4	1-3/16x12	3/4	3.95	100	41	2.51	64

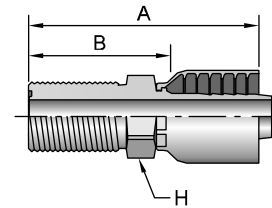

view on web page

Fittings are stocked less locknut (part no. WLNL). Locknuts are manufactured by the Parker Tube Fittings Division and must be ordered separately.

Supplied with Parker's exclusive Trap-Seal™, which leads to improved retention within Seal-Lok's™ ORFS groove and virtually eliminates costly leakage and/or time consuming pre-assembly handling.

**WARNING:** This product can expose you to chemicals including Lead, which is known to the State of California to cause cancer and birth defects or other reproductive harm. For more information go to [www.p65warnings.ca.gov](http://www.p65warnings.ca.gov).

# 1JC43

## Female Seal-Lok® - Swivel - Short

ISO 12151-1 - SWSA

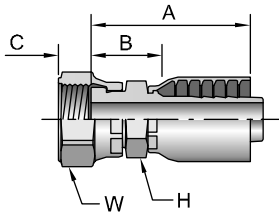

view on web page

# Part Number	Thread		Hose I.D. inch	A		C		Hexagonal Base		B		Additional Material Stainless Steel (C)
	inch	mm		inch	mm	H inch	W inch	inch	mm			
1JC43-4-4	1/4	9/16x18	1/4	1.63	41	0.32	8	9/16	11/16	0.88	22	•
1JC43-4-4-SM	1/4	9/16x18	1/4	1.63	41	0.32	8	17 mm	17 mm	0.88	22	
1JC43-4-6	1/4	9/16x18	3/8	1.90	48	0.32	8	11/16	11/16	0.87	22	
1JC43-6-4	3/8	11/16x16	1/4	1.67	42	0.32	8	11/16	13/16	0.92	23	
1JC43-6-4-SM	3/8	11/16x16	1/4	1.67	42	0.32	8	17 mm	22 mm	0.92	23	
1JC43-6-5	3/8	11/16x16	5/16	1.65	42	0.32	8	11/16	13/16	0.90	23	
1JC43-6-6	3/8	11/16x16	3/8	1.94	49	0.32	8	11/16	13/16	0.91	23	•
1JC43-6-6-SM	3/8	11/16x16	3/8	1.94	49	0.32	8	19 mm	22 mm	0.91	23	
1JC43-8-6	1/2	13/16x16	3/8	2.00	51	0.43	11	13/16	15/16	0.97	25	
1JC43-8-6-SM	1/2	13/16x16	3/8	2.00	51	0.43	11	19 mm	24 mm	0.97	25	
1JC43-8-8	1/2	13/16x16	1/2	2.22	56	0.43	11	13/16	15/16	0.96	24	•
1JC43-8-8-SM	1/2	13/16x16	1/2	2.22	56	0.43	11	22 mm	24 mm	0.96	24	
1JC43-10-8	5/8	1x14	1/2	2.30	58	0.53	13	15/16	1-1/8	1.04	26	
1JC43-10-10	5/8	1x14	5/8	2.49	63	0.53	13	15/16	1-1/8	1.05	27	•
1JC43-10-10-SM	5/8	1x14	5/8	2.49	63	0.53	13	24 mm	30 mm	1.05	27	
1JC43-12-8	3/4	1-3/16x12	1/2	2.48	63	0.57	14	1-1/8	1-3/8	1.22	31	
1JC43-12-10	3/4	1-3/16x12	5/8	2.67	68	0.57	14	1-1/8	1-3/8	1.23	31	
1JC43-12-12	3/4	1-3/16x12	3/4	2.68	68	0.57	14	1-1/8	1-3/8	1.24	31	•
1JC43-12-12-SM	3/4	1-3/16x12	3/4	2.68	68	0.57	14	32 mm	36 mm	1.24	31	
1JC43-12-16	3/4	1-3/16x12	1	2.99	76	0.57	14	1-5/16	1-3/8	1.37	35	
1JC43-16-12	1	1-7/16x12	3/4	2.83	72	0.58	15	1-3/8	1-5/8	1.39	35	
1JC43-16-16	1	1-7/16x12	1	3.14	80	0.58	15	1-3/8	1-5/8	1.52	39	•
1JC43-20-20	1-1/4	1-11/16x12	1-1/4	3.27	83	0.59	15	1-7/8	1-7/8	1.58	40	•

When measuring overall length to the end of the nut, B+C dimensions must be used to calculate cut-off allowance. Stainless steel fittings must be assembled with Karrykrimp 2, PHastkrimp, Superkrimp or Parkrimp 2. See CrimpSource for more information.

**WARNING:** This product can expose you to chemicals including Lead, which is known to the State of California to cause cancer and birth defects or other reproductive harm. For more information go to [www.p65warnings.ca.gov](http://www.p65warnings.ca.gov).

# 1JS43

## Female Seal-Lok® - Swivel - Long ISO 12151-1 SWSB

# Part Number	Thread		Hose I.D. inch	A		H inch	W inch	B	
	inch	9/16x18		inch	mm			inch	mm
1JS43-4-4	1/4	9/16x18	1/4	2.07	53	9/16	11/16	1.32	34
1JS43-4-6	1/4	9/16x18	3/8	2.21	56	11/16	11/16	1.18	30
1JS43-6-4	3/8	11/16x16	1/4	2.14	54	9/16	13/16	1.39	35
1JS43-6-6	3/8	11/16x16	3/8	2.28	58	11/16	13/16	1.25	32
1JS43-6-8	3/8	11/16x16	1/2	2.50	64	13/16	13/16	1.24	31
1JS43-8-4	1/2	13/16x16	1/4	2.26	57	11/16	15/16	1.51	38
1JS43-8-6	1/2	13/16x16	3/8	2.53	64	11/16	15/16	1.50	38
1JS43-8-8	1/2	13/16x16	1/2	2.65	67	13/16	15/16	1.39	35
1JS43-8-10	1/2	13/16x16	5/8	2.82	72	15/16	15/16	1.38	35
1JS43-10-6	5/8	1x14	3/8	2.63	67	11/16	1-1/8	1.62	41
1JS43-10-8	5/8	1x14	1/2	2.89	73	13/16	1-1/8	1.63	41
1JS43-10-10	5/8	1x14	5/8	3.07	78	15/16	1-1/8	1.66	42
1JS43-10-12	5/8	1x14	3/4	3.08	78	1-1/16	1-1/8	1.64	42
1JS43-12-8	3/4	1-3/16x12	1/2	2.90	74	15/16	1-3/8	1.64	42
1JS43-12-10	3/4	1-3/16x12	5/8	3.19	81	1-1/8	1-3/8	1.75	44
1JS43-12-12	3/4	1-3/16x12	3/4	3.31	84	1-1/8	1-3/8	1.87	47
1JS43-12-16	3/4	1-3/16x12	1	3.53	90	1-5/16	1-3/8	1.91	49
1JS43-16-12	1	1-7/16x12	3/4	3.37	86	1-3/8	1-5/8	1.93	49
1JS43-16-16	1	1-7/16x12	1	3.62	92	1-3/8	1-5/8	2.00	51
1JS43-16-20	1	1-7/16x12	1-1/4	3.77	96	1-3/4	1-5/8	2.08	53
1JS43-20-16	1-1/4	1-11/16x12	1	3.64	92	1-3/8	1-7/8	2.02	51
1JS43-20-20	1-1/4	1-11/16x12	1-1/4	3.77	96	1-3/4	1-7/8	2.15	53
1JS43-24-20	1-1/2	2x12	1-1/4	3.88	99	1-3/4	2-1/4	2.23	57
1JS43-24-24	1-1/2	2x12	1-1/2	3.91	99	1-7/8	2-1/4	2.26	65

**WARNING:** This product can expose you to chemicals including Lead, which is known to the State of California to cause cancer and birth defects or other reproductive harm. For more information go to [www.p65warnings.ca.gov](http://www.p65warnings.ca.gov).

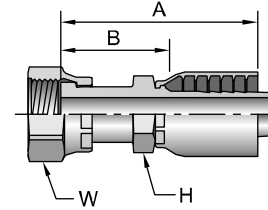

view on web page

# 1J643

## Female Seal-Lok® - Swivel - 22-1/2° Elbow End Connection per ISO 8434-3-SWE

# Part Number	Thread		Hose I.D. inch	A		E		W inch	B	
	inch	13/16x16		inch	mm	inch	mm		inch	mm
1J643-8-8	1/2	13/16x16	1/2	3.06	78	0.39	10	15/16	1.80	46

**WARNING:** This product can expose you to chemicals including Lead, which is known to the State of California to cause cancer and birth defects or other reproductive harm. For more information go to [www.p65warnings.ca.gov](http://www.p65warnings.ca.gov).

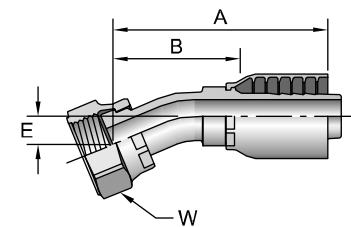

view on web page

See Accessories Section for O-Rings.

# 1J743

## Female Seal-Lok® - Swivel - 45° Elbow

ISO 12151-1 - SWE45

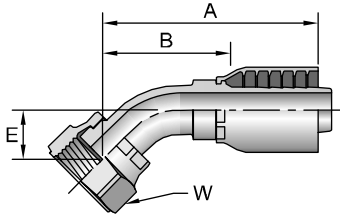

view on web page

# Part Number	Thread		Hose I.D. inch	A		E		W inch	B	
	inch	inch		inch	mm	inch	mm		inch	mm
1J743-4-4	1/4	9/16x18	1/4	1.97	50.0	0.39	10	11/16	1.22	31.0
1J743-4-4-SM	1/4	9/16x18	1/4	1.97	50.0	0.39	10	17 mm	1.22	31.0
1J743-4-6	1/4	9/16x18	3/8	2.23	57.0	0.39	10	11/16	1.20	30.0
1J743-6-4	3/8	11/16x16	1/4	2.08	53.0	0.43	11	13/16	1.33	34.0
1J743-6-4-SM	3/8	11/16x16	1/4	2.08	53.0	0.43	11	22 mm	1.33	34.0
1J743-6-5	3/8	11/16x16	5/16	2.37	60.0	0.43	11	13/16	1.62	41.0
1J743-6-6	3/8	11/16x16	3/8	2.74	69.5	0.43	11	13/16	1.71	43.4
1J743-6-8	3/8	11/16x16	1/2	2.66	68.0	0.43	11	13/16	1.41	36.0
1J743-8-4	1/2	13/16x16	1/4	2.56	65.0	0.59	15	15/16	1.81	46.0
1J743-8-6	1/2	13/16x16	3/8	2.53	64.0	0.59	15	15/16	1.50	38.0
1J743-8-6-SM	1/2	13/16x16	3/8	2.53	64.0	0.59	15	24 mm	1.50	38.0
1J743-8-8	1/2	13/16x16	1/2	3.20	81.2	0.59	15	15/16	1.94	49.3
1J743-8-8-SM	1/2	13/16x16	1/2	3.20	81.2	0.59	15	24 mm	1.94	49.3
1J743-8-10	1/2	13/16x16	5/8	3.09	78.0	0.59	15	15/16	1.65	42.0
1J743-10-8	5/8	1x14	1/2	2.93	74.0	0.63	16	1-1/8	1.67	42.0
1J743-10-10	5/8	1x14	5/8	3.17	81.0	0.63	16	1-1/8	1.73	44.0
1J743-10-12	5/8	1x14	3/4	3.36	85.0	0.65	16	1-1/8	1.93	49.0
1J743-12-8	3/4	1-3/16x12	1/2	3.57	91.0	0.82	21	1-3/8	2.31	59.0
1J743-12-10	3/4	1-3/16x12	5/8	3.62	92.0	0.83	21	1-3/8	2.18	55.0
1J743-12-12	3/4	1-3/16x12	3/4	3.63	92.0	0.83	21	1-3/8	2.19	56.0
1J743-12-16	3/4	1-3/16x12	1	3.67	93.0	0.81	21	1-3/8	2.05	52.0
1J743-16-12	1	1-7/16x12	3/4	4.02	102.0	0.94	24	1-5/8	2.59	66.0
1J743-16-16	1	1-7/16x12	1	4.38	111.0	0.94	24	1-5/8	2.76	70.0
1J743-16-20	1	1-7/16x12	1-1/4	4.59	117.0	0.94	24	1-5/8	2.94	75.0
1J743-20-16	1-1/4	1-11/16x12	1	4.52	115.0	1.00	25	1-7/8	2.93	74.0
1J743-20-20	1-1/4	1-11/16x12	1-1/4	4.78	121.0	1.00	25	1-7/8	3.09	78.0
1J743-24-20	1-1/2	2x12	1-1/4	4.99	127.0	1.11	28	2-1/4	3.30	84.0
1J743-24-24	1-1/2	2x12	1-1/2	4.70	119.0	1.07	27	2-1/4	3.33	85.0

**WARNING:** This product can expose you to chemicals including Lead, which is known to the State of California to cause cancer and birth defects or other reproductive harm. For more information go to [www.p65warnings.ca.gov](http://www.p65warnings.ca.gov).

# 1J943

## Female Seal-Lok® - Swivel - 90° Elbow - Short Drop ISO 12151-1 - SWES90

# Part Number	Thread		Hose I.D. inch	A		E		W inch	B	
	inch	inch		inch	mm	inch	mm		inch	mm
1J943-4-4	1/4	9/16x18	1/4	1.78	45	0.83	21	11/16	1.03	26
1J943-4-6	1/4	9/16x18	3/8	2.05	52	0.83	21	11/16	1.02	26
1J943-6-4	3/8	11/16x16	1/4	1.93	49	0.91	23	13/16	1.18	30
1J943-6-6	3/8	11/16x16	3/8	2.21	56	0.91	23	13/16	1.18	30
1J943-6-8	3/8	11/16x16	1/2	2.53	64	0.90	23	13/16	1.27	32
1J943-8-4	1/2	13/16x16	1/4	2.28	58	1.15	29	15/16	1.53	39
1J943-8-6	1/2	13/16x16	3/8	2.28	58	1.14	29	15/16	1.25	32
1J943-8-8	1/2	13/16x16	1/2	2.59	66	1.14	29	15/16	1.33	34
1J943-8-8-SM	1/2	13/16x16	1/2	2.59	66	1.14	29	24 mm	1.33	34
1J943-8-10	1/2	13/16x16	5/8	2.81	71	1.15	29	15/16	1.37	35
1J943-10-8	5/8	1x14	1/2	2.74	70	1.26	32	1-1/8	1.48	38
1J943-10-10	5/8	1x14	5/8	2.97	75	1.26	32	1-1/8	1.53	39
1J943-10-10-SM	5/8	1x14	5/8	2.97	75	1.26	32	30 mm	1.53	39
1J943-10-12	5/8	1x14	3/4	3.08	78	1.27	32	1-1/8	1.64	42
1J943-12-8	3/4	1-3/16x12	1/2	3.21	82	1.89	48	1-3/8	1.95	50
1J943-12-10	3/4	1-3/16x12	5/8	3.49	89	1.89	48	1-3/8	2.05	52
1J943-12-12	3/4	1-3/16x12	3/4	3.06	78	1.89	48	1-3/8	2.05	52
1J943-12-16	3/4	1-3/16x12	1	3.88	99	1.89	48	1-3/8	2.26	57
1J943-16-12	1	1-7/16x12	3/4	4.06	103	2.22	56	1-5/8	2.62	67
1J943-16-16	1	1-7/16x12	1	4.31	109	2.20	56	1-5/8	2.69	68
1J943-16-20	1	1-7/16x12	1-1/4	4.56	116	2.21	56	1-5/8	2.87	73
1J943-20-16	1-1/4	1-11/16x12	1	4.64	118	2.54	65	1-7/8	3.02	80
1J943-20-20	1-1/4	1-11/16x12	1-1/4	4.88	124	2.51	64	1-7/8	3.19	81
1J943-24-24	1-1/2	2x12	1-1/2	5.50	140	2.68	68	2-1/4	4.13	105

**WARNING:** This product can expose you to chemicals including Lead, which is known to the State of California to cause cancer and birth defects or other reproductive harm. For more information go to [www.p65warnings.ca.gov](http://www.p65warnings.ca.gov).

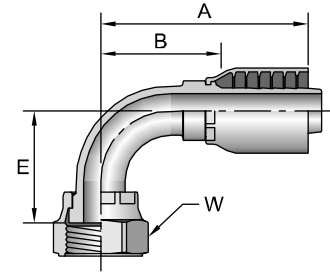

view on web page

# 1J543

## Female Seal-Lok® - Swivel - 90° Elbow - Medium Drop ISO 12151-1 - SWEM90

# Part Number	Thread		Hose I.D. inch	A		E		W inch	B	
	inch	inch		inch	mm	inch	mm		inch	mm
1J543-4-4	1/4	9/16x18	1/4	2.07	53	1.26	32	11/16	1.32	34
1J543-6-4	3/8	11/16x16	1/4	2.12	54	1.50	38	13/16	1.41	36
1J543-6-6	3/8	11/16x16	3/8	2.40	61	1.50	38	13/16	1.37	35
1J543-8-6	1/2	13/16x16	3/8	2.48	63	1.61	41	15/16	1.45	37
1J543-8-8	1/2	13/16x16	1/2	2.59	66	1.61	41	15/16	1.33	34
1J543-10-8	5/8	1x14	1/2	2.74	70	1.85	47	1-1/8	1.48	38
1J543-10-10	5/8	1x14	5/8	2.97	75	1.85	47	1-1/8	1.53	39
1J543-10-12	5/8	1x14	3/4	3.12	79	1.88	48	1-1/8	1.68	43
1J543-12-12	3/4	1-3/16x12	3/4	3.49	89	2.28	58	1-3/8	2.05	52
1J543-16-16	1	1-7/16x12	1	4.86	123	2.78	71	1-5/8	3.27	83
1J543-20-20	1-1/4	1-11/16x12	1-1/4	4.89	124	3.09	78	1-7/8	3.20	81

**WARNING:** This product can expose you to chemicals including Lead, which is known to the State of California to cause cancer and birth defects or other reproductive harm. For more information go to [www.p65warnings.ca.gov](http://www.p65warnings.ca.gov).

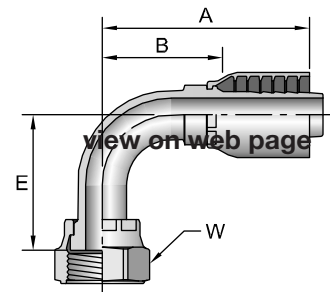

view on web page

# 1J143

## Female Seal-Lok® - Swivel - 90° Elbow - Long Drop

ISO 12151-1 - SWEL90

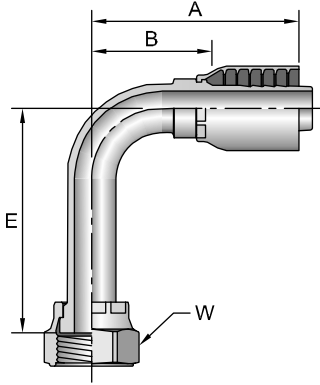

view on web page

# Part Number	Thread		Hose I.D. inch	A		E		W inch	B	
	inch	inch		inch	mm	inch	mm		inch	mm
1J143-4-4	1/4	9/16x18	1/4	2.02	51	1.81	46	11/16	1.27	32
1J143-6-4	3/8	11/16x16	1/4	2.26	57	2.13	54	13/16	1.51	38
1J143-6-6	3/8	11/16x16	3/8	2.39	61	2.13	54	13/16	1.36	35
1J143-8-6	1/2	13/16x16	3/8	2.45	62	2.52	64	15/16	1.42	36
1J143-8-8	1/2	13/16x16	1/2	2.59	66	2.52	64	15/16	1.33	34
1J143-10-8	5/8	1x14	1/2	2.74	70	2.79	71	1-1/8	1.48	38
1J143-10-10	5/8	1x14	5/8	2.97	75	2.76	70	1-1/8	1.53	39
1J143-10-12	5/8	1x14	3/4	3.15	80	2.76	70	1-1/8	1.73	44
1J143-12-12	3/4	1-3/16x12	3/4	3.49	89	3.78	96	1-3/8	2.05	52
1J143-16-16	1	1-7/16x12	1	4.28	109	4.49	114	1-5/8	2.66	68
1J143-20-20	1-1/4	1-11/16x12	1-1/4	4.84	123	5.09	129	1-7/8	3.15	80
1J143-24-20	1-1/2	2x12	1-1/4	4.77	121	5.54	141	2-1/4	3.12	79

**WARNING:** This product can expose you to chemicals including Lead, which is known to the State of California to cause cancer and birth defects or other reproductive harm. For more information go to [www.p65warnings.ca.gov](http://www.p65warnings.ca.gov).

## Universal Push-to-Connect (UPTC) Introduction

Traditionally, the fluid power industry has used threaded connectors to make a leak free connection. The speed of making connections is slow and the reliability of the connection is dependent on proper assembly procedures. Parker’s UPTC connectors rely on a mechanical retaining mechanism (other than threads) to create a seal.

Tools are not required for assembly, and the reliability and speed of making connections with the UPTC design is greatly improved compared to traditional threaded connections.

### Features

- Available in sizes 1/4”, 3/8”, 1/2”, 5/8”, and 3/4”
- Uses standard Seal-Lok adapters for a wide variety of configurations, as well as excellent field serviceability
- Meets or exceeds SAE 100R2 pressure ratings (see Fig. 2)
- Includes visual and tactile installation indicators
- Seal-aligning nipple eliminates hose twist during assembly
- No special tooling required for disassembly
- Uses elastomeric seals, including Parker’s patented Trap-Seal

## Design and Construction

UPTC Seal-Lok consists of a base Seal-Lok ORFS fitting, a UPTC nut (including internal sealing and retaining elements), a dust O-Ring, and a UPTC hose assembly or rigid tube, as shown in figure 1. The base ORFS fitting is a highly reliable and widely available off-the-shelf standard SAE J1453 adapter. The sealing O-Ring is supported by a pressure energized anti-extrusion ring that prevents O-Ring extrusion and ensures tight sealing even under high pressure.

Once fully engaged, the retaining element is positively trapped between the male and UPTC nut. The dust O-Ring keeps contamination out and serves as a full engagement visual indicator. A clear tactile feeling at the end of the push indicates a proper connection. Once a proper connection is made, the dust O-Ring is covered by the UPTC nut. This also serves as a positive visual indicator of full engagement for easy inspection and quality control.

Once connected, the UPTC nut is permanently attached to the UPTC hose end similar to a traditional swivel nut. To disconnect, just use a wrench to unscrew the UPTC nut from the base adapter. Re-connect is possible by tightening the UPTC nut back to the base adapter, if the connection is not damaged. If the hose or tube is damaged, they can be replaced by installing a new UPTC assembly or a readily available standard Seal-Lok ORFS hose or tube assembly.



Fig. 1a

Fig. 1b

Fig. 1a — This is a Tube Fittings Division part. Information can be found in Catalog 4300.

### UPTC Pressure Ratings

Size	Pressure (psi)	Pressure (Bar)
-4	5800	400
-6	5000	345
-8	4250	293
-10	4000	276
-12	3125	216

## 1EN43 UPTC Male

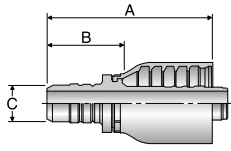

view on web page

# Part Number	Hose End Size inch	A inch	B inch	C Nominal Connection Size	
				inch	mm
1EN43-8-4	1/4	1.83	1.08	0.31	8
1EN43-12-6	3/8	2.15	1.12	0.47	12
1EN43-15-8	1/2	2.51	1.25	0.59	15
1EN43-18-10	5/8	2.78	1.34	0.71	18
1EN43-22-12	3/4	2.81	1.37	0.87	22

**WARNING:** This product can expose you to chemicals including Lead, which is known to the State of California to cause cancer and birth defects or other reproductive harm. For more information go to [www.p65warnings.ca.gov](http://www.p65warnings.ca.gov).

## 1ET43 UPTC Male 90° Elbow

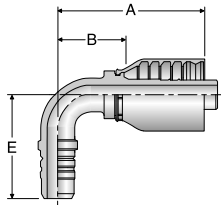

view on web page

# Part Number	Hose End Size inch	A inch	B inch	C Nominal Connection Size		E inch
				inch	mm	
1ET43-8-4	1/4	1.78	1.03	0.31	8	1.54
1ET43-12-6	3/8	2.21	1.18	0.47	12	1.54
1ET43-15-8	1/2	2.51	1.25	0.59	15	1.77
1ET43-18-10	5/8	2.97	1.53	0.71	18	2.24
1ET43-22-12	3/4	3.43	1.99	0.87	22	2.50

**WARNING:** This product can expose you to chemicals including Lead, which is known to the State of California to cause cancer and birth defects or other reproductive harm. For more information go to [www.p65warnings.ca.gov](http://www.p65warnings.ca.gov).

## 1EU43 UPTC Male 45° Elbow

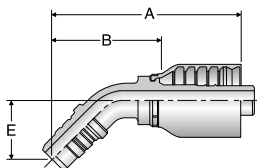

view on web page

# Part Number	Hose End Size inch	A inch	B inch	C Nominal Connection Size		E inch
				inch	mm	
1EU43-8-4	1/4	2.48	1.73	0.31	8	0.91
1EU43-12-6	3/8	2.83	1.80	0.47	12	0.91
1EU43-15-8	1/2	3.17	1.91	0.59	15	0.99
1EU43-18-10	5/8	3.68	2.24	0.71	18	1.26
1EU43-22-12	3/4	3.76	2.32	0.87	22	1.30

**WARNING:** This product can expose you to chemicals including Lead, which is known to the State of California to cause cancer and birth defects or other reproductive harm. For more information go to [www.p65warnings.ca.gov](http://www.p65warnings.ca.gov).



# 1D043

## Male Metric L - Rigid - (24° Cone)

ISO 12151-2

# Part Number	Thread mm	Hose I.D. inch	A		H mm	B		
			inch	mm		inch	mm	
1D043-6-4	6	M12x1,5	1/4	1.73	44	14	0.93	24
1D043-8-4	8	M14x1,5	1/4	1.61	41	14	0.93	24
1D043-10-5	10	M16x1,5	5/16	1.97	50	19	0.83	21
1D043-10-6	10	M16x1,5	3/8	1.97	50	19	0.83	21
1D043-12-6	12	M18x1,5	3/8	1.97	50	19	0.83	21
1D043-15-6	15	M22x1,5	3/8	1.93	49	22	1.02	26
1D043-15-8	15	M22x1,5	1/2	2.28	58	22	0.94	24
1D043-18-10	18	M26x1,5	5/8	2.68	68	27	1.14	29
1D043-18-12	18	M26x1,5	3/4	2.68	68	27	1.14	29
1D043-22-12	22	M30x2	3/4	2.72	69	30	1.22	31
1D043-28-16	28	M36x2	1	3.11	79	36	1.30	33
1D043-35-20	35	M45x2	1-1/4	3.35	85	46	1.50	38

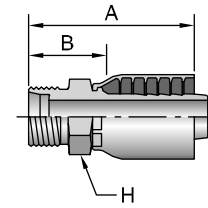

view on web page

**WARNING:** This product can expose you to chemicals including Lead, which is known to the State of California to cause cancer and birth defects or other reproductive harm. For more information go to [www.p65warnings.ca.gov](http://www.p65warnings.ca.gov).

# 11D43

## Male Standpipe Metric L - Rigid

End Connection per ISO 8434-1-SDS

# Part Number	R mm	Hose I.D. inch	A		D		B	
			inch	mm	inch	mm	inch	mm
11D43-6-4	6	1/4	2.03	52	0.87	22	1.28	33
11D43-10-5	10	5/16	2.36	60	0.91	23	1.45	37
11D43-10-6	10	3/8	2.28	58	0.91	23	1.14	29
11D43-15-8	15	1/2	2.56	65	0.98	25	1.22	31
11D43-18-10	18	5/8	2.99	76	1.02	26	1.48	38
11D43-18-12	18	3/4	2.80	71	1.02	26	1.22	31
11D43-22-12	22	3/4	2.87	73	1.10	28	1.26	32
11D43-28-16	28	1	3.31	84	1.18	30	1.46	37

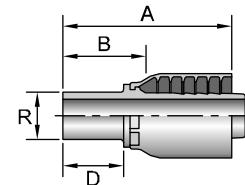

view on web page

Metric L: Mates with EO "L" Series Fittings. See Accessories Section for O-Rings.

**WARNING:** This product can expose you to chemicals including Lead, which is known to the State of California to cause cancer and birth defects or other reproductive harm. For more information go to [www.p65warnings.ca.gov](http://www.p65warnings.ca.gov).

## 1C343 Female Metric L - Swivel - (Ball Nose)

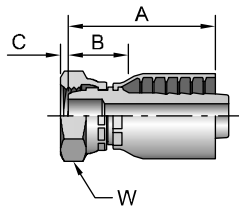

view on web page

# Part Number	Thread		Hose I.D. inch	A		C		W mm	B	
	mm	mm		inch	mm	inch	mm		inch	mm
1C343-6-4	6	M12x1,5	1/4	1.75	44	0.09	2	14	1.16	29
1C343-8-4	8	M14x1,5	1/4	1.77	45	0.11	3	17	1.16	29
1C343-10-5	10	M16x1,5	5/16	2.01	51	0.06	2	19	1.20	30
1C343-10-6	10	M16x1,5	3/8	2.06	52	0.06	2	19	1.10	28
1C343-12-5	12	M18x1,5	5/16	1.87	47	0.10	3	22	0.70	18
1C343-12-6	12	M18x1,5	3/8	2.23	57	0.10	3	22	1.18	30
1C343-15-6	6	M22x1,5	3/8	1.85	47	0.16	4	27	0.71	18
1C343-15-8	15	M22x1,5	1/2	2.42	61	0.17	4	27	1.29	33
1C343-18-10	18	M26x1,5	5/8	2.65	67	0.10	3	32	1.23	31
1C343-18-12	18	M26x1,5	3/4	2.80	71	0.10	3	32	1.37	35
1C343-22-12	22	M30x2	3/4	2.87	73	0.18	5	36	1.42	36
1C343-28-16	28	M36x2	1	3.35	85	0.22	6	46	1.76	45

When measuring overall length to the end of the nut, B+C dimensions must be used to calculate cut-off allowance.

**WARNING:** This product can expose you to chemicals including Lead, which is known to the State of California to cause cancer and birth defects or other reproductive harm. For more information go to [www.p65warnings.ca.gov](http://www.p65warnings.ca.gov).

## 1C443 Female Metric L - Swivel - 45° Elbow - (Ball Nose)

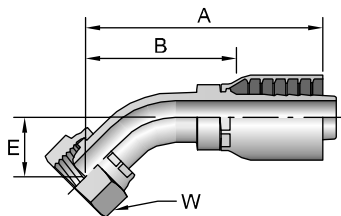

view on web page

# Part Number	Thread		Hose I.D. inch	A		E		W mm	B	
	mm	mm		inch	mm	inch	mm		inch	mm
1C443-8-4	8	M14x1,5	1/4	2.40	61	0.59	15	17	1.50	38
1C443-10-5	10	M16x1,5	5/16	2.60	66	0.67	17	19	1.61	41
1C443-10-6	10	M16x1,5	3/8	2.76	70	0.67	17	19	1.61	41
1C443-12-6	12	M18x1,5	3/8	2.76	70	0.67	17	22	1.61	41
1C443-15-8	15	M22x1,5	1/2	3.35	85	0.79	20	27	1.97	50
1C443-18-10	18	M26x1,5	5/8	4.09	104	1.14	29	32	2.52	64
1C443-22-12	22	M30x2	3/4	3.78	96	0.91	23	36	2.20	56
1C443-28-16	28	M36x2	1	4.53	115	1.10	28	46	2.81	71

**WARNING:** This product can expose you to chemicals including Lead, which is known to the State of California to cause cancer and birth defects or other reproductive harm. For more information go to [www.p65warnings.ca.gov](http://www.p65warnings.ca.gov).

## 1C543 Female Metric L - Swivel - 90° Elbow - (Ball Nose)

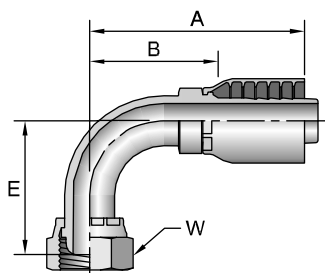

view on web page

# Part Number	Thread		Hose I.D. inch	A		E		W mm	B	
	mm	mm		inch	mm	inch	mm		inch	mm
1C543-8-4	8	M14x1,5	1/4	2.05	52	1.10	28	17	1.18	30
1C543-10-5	10	M16x1,5	5/16	2.20	56	1.18	30	19	1.22	31
1C543-10-6	10	M16x1,5	3/8	2.40	61	1.18	30	19	1.40	36
1C543-12-6	12	M18x1,5	3/8	2.40	61	1.22	31	22	1.40	36
1C543-15-8	15	M22x1,5	1/2	2.95	75	1.57	40	27	1.57	40
1C543-18-10	18	M26x1,5	5/8	3.58	91	2.36	60	32	2.05	52
1C543-22-12	22	M30x2	3/4	3.58	91	1.97	50	36	2.00	51
1C543-28-16	28	M36x2	1	4.33	110	2.48	63	46	2.56	65

**WARNING:** This product can expose you to chemicals including Lead, which is known to the State of California to cause cancer and birth defects or other reproductive harm. For more information go to [www.p65warnings.ca.gov](http://www.p65warnings.ca.gov).

Metric L: Mates with EO "L" Series Fittings.

# 1CA43

## Female Metric L - Swivel - (24° Cone with O-Ring)

ISO 12151-2 - SWS

# Part Number	Thread mm	Hose I.D. inch	A		C inch	W mm	B	
			inch	mm			inch	mm
1CA43-6-4	6 M12x1,5	1/4	1.73	44	-0.02	14	0.88	22
1CA43-8-4	8 M14x1,5	1/4	1.73	44	-0.01	17	0.88	22
1CA43-8-5	8 M14x1,5	5/16	1.97	50	0.00	17	1.02	26
1CA43-10-4	10 M16x1,5	1/4	1.81	46	0.04	19	0.87	22
1CA43-10-5	10 M16x1,5	5/16	1.81	46	0.04	19	0.87	22
1CA43-10-6	10 M16x1,5	3/8	2.08	53	0.02	19	1.05	27
1CA43-12-5	12 M18x1,5	5/16	1.81	46	0.04	22	0.91	23
1CA43-12-6	12 M18x1,5	3/8	1.89	48	0.03	22	0.75	19
1CA43-15-8	15 M22x1,5	1/2	2.20	56	0.07	27	0.82	21
1CA43-18-10	18 M26x1,5	5/8	2.44	62	0.02	32	0.87	22
1CA43-18-12	18 M26x1,5	3/4	2.56	65	0.02	32	1.02	26
1CA43-22-12	22 M30x2	3/4	2.48	63	0.13	36	1.05	24
1CA43-28-16	28 M36x2	1	3.07	78	0.14	41	1.30	33
1CA43-35-20	35 M45x2	1-1/4	3.23	82	0.00	50	1.38	35
1CA43-42-24	42 M52x2	1-1/2	3.02	77	0.07	60	1.65	42

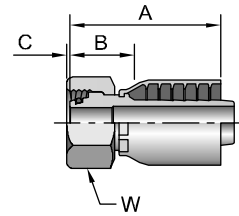

view on web page

When measuring overall length to the end of the nut, B+C dimensions must be used to calculate cut-off allowance.

**WARNING:** This product can expose you to chemicals including Lead, which is known to the State of California to cause cancer and birth defects or other reproductive harm. For more information go to [www.p65warnings.ca.gov](http://www.p65warnings.ca.gov).

# 1CE43

## Female Metric L - Swivel - 45° Elbow - (24° Cone with O-Ring)

ISO 12151-2 - SWE45

# Part Number	Thread mm	Hose I.D. inch	A		E		W mm	B	
			inch	mm	inch	mm		inch	mm
1CE43-6-4	6 M12x1,5	1/4	2.68	68	0.75	19	14	1.77	45
1CE43-8-4	8 M14x1,5	1/4	2.32	59	0.63	16	17	1.38	35
1CE43-10-5	10 M16x1,5	5/16	2.64	67	0.59	15	19	1.69	43
1CE43-10-6	10 M16x1,5	3/8	2.95	75	0.75	19	19	1.85	47
1CE43-12-6	12 M18x1,5	3/8	2.72	69	0.75	19	22	1.53	39
1CE43-15-8	15 M22x1,5	1/2	3.19	81	0.87	22	27	1.81	46
1CE43-18-10	18 M26x1,5	5/8	3.50	89	0.91	23	32	1.93	49
1CE43-22-12	22 M30x2	3/4	3.86	98	1.02	26	36	2.28	58
1CE43-28-16	28 M36x2	1	4.92	125	1.34	34	41	3.30	84

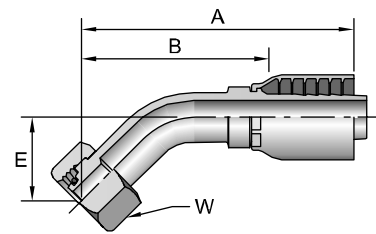

view on web page

**WARNING:** This product can expose you to chemicals including Lead, which is known to the State of California to cause cancer and birth defects or other reproductive harm. For more information go to [www.p65warnings.ca.gov](http://www.p65warnings.ca.gov).

# 1CF43

## Female Metric L - Swivel - 90° Elbow - (24° Cone with O-Ring) ISO 12151-2 - SWE

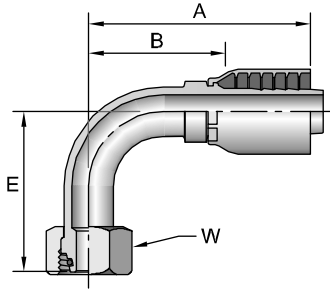

view on web page

# Part Number	Thread mm	Hose I.D. inch	A		E		W	B	
			inch	mm	inch	mm	mm	inch	mm
1CF43-8-4	8 M14x1,5	1/4	2.01	51	1.14	29	17	1.10	28
1CF43-10-4	10 M16x1,5	1/4	2.05	52	1.14	29	19	1.10	28
1CF43-10-5	10 M16x1,5	5/16	2.40	61	1.16	29	19	1.46	37
1CF43-10-6	10 M16x1,5	3/8	2.56	65	1.38	35	19	1.46	37
1CF43-12-6	12 M18x1,5	3/8	2.52	64	1.42	36	22	1.38	35
1CF43-15-8	15 M22x1,5	1/2	2.80	71	1.69	43	27	1.46	37
1CF43-18-10	18 M26x1.5	5/8	3.17	81	1.77	45	32	1.61	41
1CF43-22-12	22 M30x2	3/4	3.50	89	2.17	55	36	1.93	49
1CF43-28-16	28 M36x2	1	4.44	113	3.07	78	41	2.82	72
1CF43-35-20	35 M45x2	1-1/4	5.12	130	3.11	79	50	3.27	83

Metric L: Mates with EO "L" Series Fittings.

**WARNING:** This product can expose you to chemicals including Lead, which is known to the State of California to cause cancer and birth defects or other reproductive harm. For more information go to [www.p65warnings.ca.gov](http://www.p65warnings.ca.gov).

# 1D243

## Male Metric S - Rigid - (24° Cone) ISO 12151-2

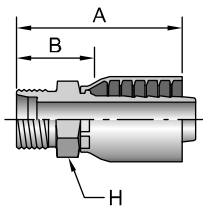



view on web page

# Part Number	Thread mm	Hose I.D. inch	A		H	B	
			inch	mm	mm	inch	mm
1D243-8-4	8 M16x1,5	1/4	1.73	44	17	0.87	22
1D243-10-4	10 M18x1,5	1/4	1.73	44	19	0.87	22
1D243-12-5	12 M20x1,5	5/16	2.20	56	22	1.29	33
1D243-12-6	12 M20x1,5	3/8	1.97	50	22	1.02	26
1D243-14-6	14 M22x1,5	3/8	2.17	55	22	0.98	25
1D243-16-8	16 M24x1,5	1/2	2.36	60	24	1.17	30
1D243-20-10	20 M30x2	5/8	2.95	75	30	1.44	37
1D243-25-12	25 M36x2	3/4	2.87	73	36	1.30	33
1D243-30-16	30 M42x2	1	3.39	86	46	1.54	39

**WARNING:** This product can expose you to chemicals including Lead, which is known to the State of California to cause cancer and birth defects or other reproductive harm. For more information go to [www.p65warnings.ca.gov](http://www.p65warnings.ca.gov).

# 13D43

## Male Standpipe Metric S - Rigid End Connection per ISO 8434-1-SDS

# Part Number			A		D		B	
	R mm	Hose I.D. inch	inch	mm	inch	mm	inch	mm
13D43-10-4	10	1/4	2.13	54	1.02	26	1.26	32
13D43-16-8	16	1/2	2.68	68	1.18	30	1.42	36
13D43-20-10	20	5/8	3.39	86	1.42	36	1.88	48
13D43-20-12	20	3/4	3.19	81	1.42	36	1.57	40
13D43-25-12	25	3/4	3.35	85	1.57	40	1.73	44

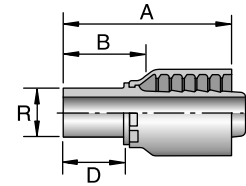



view on web page

Light Series 11D43-6-4, 11D43-8-4 and 11D43-12-6 are used in place of their Heavy Series equivalent size and accept the EO Heavy "S" Series ferrules and nuts.

**WARNING:** This product can expose you to chemicals including Lead, which is known to the State of California to cause cancer and birth defects or other reproductive harm. For more information go to [www.p65warnings.ca.gov](http://www.p65warnings.ca.gov).

# 1C643

## Female Metric S - Swivel - (Ball Nose)

# Part Number			A		C			B	
	Thread mm	Hose I.D. inch	inch	mm	inch	mm	W mm	inch	mm
1C643-8-4	8 M16x1,5	1/4	1.57	40	0.15	4	19	1.20	30
1C643-10-4	10 M18x1,5	1/4	1.63	41	0.10	3	22	1.20	30
1C643-12-6	12 M20x1,5	3/8	1.76	45	0.08	2	24	1.32	34
1C643-12-8	12 M20x1,5	1/2	2.18	55	0.08	2	24	1.30	33
1C643-14-6	14 M22x1,5	3/8	1.94	49	0.17	4	27	1.32	34
1C643-16-8	16 M24x1,5	1/2	2.13	54	0.19	5	30	1.39	35
1C643-20-10	20 M30x2	5/8	2.38	60	0.21	5	36	1.39	35
1C643-20-12	20 M30x2	3/4	2.46	62	0.21	5	40	1.03	37
1C643-25-12	25 M36x2	3/4	2.48	63	0.28	7	46	1.56	40
1C643-30-16	30 M42x2	1	2.89	73	0.37	9	50	1.95	50

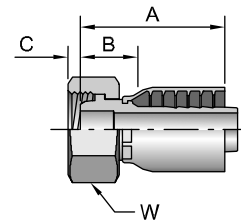

view on web page

Metric L: Mates with EO "L" Series Fittings.

Metric S: Mates with EO "S" Series Fittings.

**WARNING:** This product can expose you to chemicals including Lead, which is known to the State of California to cause cancer and birth defects or other reproductive harm. For more information go to [www.p65warnings.ca.gov](http://www.p65warnings.ca.gov).

### 1C043 Female Metric - Swivel - (Ball Nose)

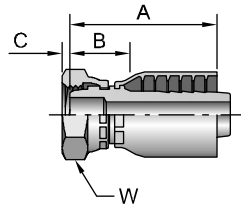

view on web page

# Part Number	Thread		Hose I.D. inch	A		C		W mm	B	
	mm	mm		inch	mm	inch	mm		inch	mm
1C043-20-12	20	M30x1,5	3/4	2.48	63	0.21	5	36	0.94	24
1C043-25-16	25	M38x1,5	1	2.99	76	0.28	7	46	1.14	29

**WARNING:** This product can expose you to chemicals including Lead, which is known to the State of California to cause cancer and birth defects or other reproductive harm. For more information go to [www.p65warnings.ca.gov](http://www.p65warnings.ca.gov).

### 1C943 Female Metric S - Swivel - (24° Cone with O-Ring) ISO 12151-2 - SWS

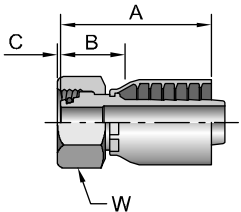

view on web page

# Part Number	Thread		Hose I.D. inch	A		C		W mm	B	
	mm	mm		inch	mm	inch	mm		inch	mm
1C943-6-4	6	M14x1,5	1/4	1.89	48	0.01	0	17	1.02	26
1C943-8-4	8	M16x1,5	1/4	1.77	45	0.01	0	19	0.91	23
1C943-10-4	10	M18x1,5	1/4	1.81	46	0.01	0	22	0.87	22
1C943-10-6	10	M18x1,5	3/8	1.97	50	0.01	0	22	0.83	21
1C943-12-5	12	M20x1,5	5/16	1.89	48	0.03	1	24	0.94	24
1C943-12-6	12	M20x1,5	3/8	2.05	52	0.03	1	24	0.87	22
1C943-14-6	14	M22x1,5	3/8	1.97	50	0.03	1	27	0.83	21
1C943-16-8	16	M24x1,5	1/2	2.33	59	0.09	2	30	0.94	24
1C943-20-10	20	M30x2	5/8	2.59	66	0.05	1	36	1.06	27
1C943-20-12	20	M30x2	3/4	2.59	66	0.05	1	36	1.06	27
1C943-25-12	25	M36x2	3/4	2.67	68	0.10	3	46	1.10	28
1C943-25-16	25	M36x2	1	3.07	78	0.08	2	46	1.30	33
1C943-30-16	30	M42x2	1	3.03	77	0.19	5	50	1.26	32
1C943-38-20	38	M52x2	1-1/4	3.15	80	0.23	6	60	1.30	33

**WARNING:** This product can expose you to chemicals including Lead, which is known to the State of California to cause cancer and birth defects or other reproductive harm. For more information go to [www.p65warnings.ca.gov](http://www.p65warnings.ca.gov).

# 10C43

## Female Metric S - Swivel - 45° Elbow - (24° Cone with O-Ring) ISO 12151-2 - SWE45

# Part Number	Thread		Hose I.D. inch	A		E		W mm	B	
	mm	mm		inch	mm	inch	mm		inch	mm
10C43-8-4	8	M16x1,5	1/4	2.32	59	0.63	16	19	1.38	35
10C43-12-6	12	M20x1,5	3/8	2.72	69	0.79	20	24	1.57	40
10C43-14-6	14	M22x1,5	3/8	2.99	76	0.79	20	27	1.96	50
10C43-16-8	16	M24x1,5	1/2	3.23	82	0.94	24	30	1.89	48
10C43-20-10	20	M30x2	5/8	3.58	91	0.98	25	36	2.05	52
10C43-20-12	20	M30x2	3/4	3.94	100	1.14	29	36	2.36	60
10C43-25-12	25	M36x2	3/4	3.97	101	1.18	30	46	2.40	61
10C43-30-16	30	M42x2	1	4.96	126	1.42	36	50	3.11	79
10C43-38-20^^	38	M52x2	1-1/4	5.59	142	1.50	38	60	3.74	95

^^Must be assembled with Die Part No. 83C-A20H in a Superkrimp or Parkrimp 2.

**WARNING:** This product can expose you to chemicals including Lead, which is known to the State of California to cause cancer and birth defects or other reproductive harm. For more information go to [www.p65warnings.ca.gov](http://www.p65warnings.ca.gov).

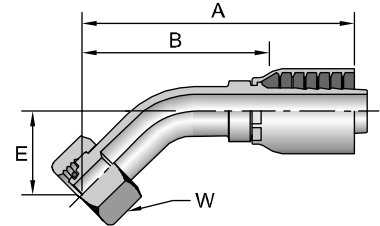

view on web page

# 11C43

## Female Metric S - Swivel - 90° Elbow - (24° Cone with O-Ring) ISO 12151-2 - SWE

# Part Number	Thread		Hose I.D. inch	A		E		W mm	B	
	mm	mm		inch	mm	inch	mm		inch	mm
11C43-8-4	8	M16x1,5	1/4	1.89	48	1.14	29	19	1.02	26
11C43-10-4	10	M18x1,5	1/4	1.97	50	1.14	29	22	1.02	26
11C43-12-5	12	M20x1,5	5/16	2.36	60	1.26	32	24	1.42	36
11C43-12-6	12	M20x1,5	3/8	2.56	65	1.46	37	24	1.38	35
11C43-14-6	14	M22x1,5	3/8	2.56	65	1.46	37	27	1.38	35
11C43-16-8	16	M24x1,5	1/2	2.83	72	1.77	45	30	1.46	37
11C43-20-10	20	M30x2	5/8	3.11	79	1.89	48	36	1.57	40
11C43-20-12	20	M30x2	3/4	3.52	89	2.26	58	36	2.08	53
11C43-25-12	25	M36x2	3/4	3.50	89	2.32	59	46	1.93	49
11C43-25-16	25	M36x2	1	4.29	109	2.72	69	46	2.67	68
11C43-30-16	30	M42x2	1	4.53	115	2.99	76	50	2.68	68
11C43-38-20^^	38	M52x2	1-1/4	5.12	130	3.15	80	60	3.27	83

^^Must be assembled with Die Part No. 83C-A20H in a Superkrimp or Parkrimp 2.

**WARNING:** This product can expose you to chemicals including Lead, which is known to the State of California to cause cancer and birth defects or other reproductive harm. For more information go to [www.p65warnings.ca.gov](http://www.p65warnings.ca.gov).

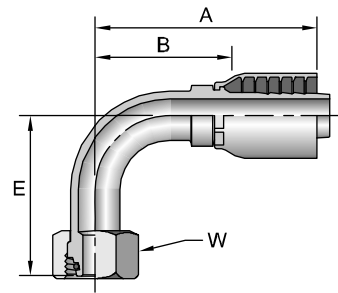

view on web page

When used in a port, a bonded seal must be used. See Accessories Section for more information.

# 1D943

## Male BSP Parallel Pipe - Rigid - (60° Cone)

ISO 12151-6

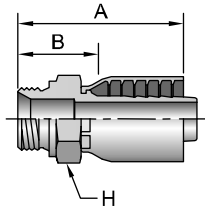

view on web page

# Part Number	Thread inch	Hose I.D. inch	A		H mm	B	
			inch	mm		inch	mm
1D943-4-4	1/4x19	1/4	1.77	45	19	0.91	23
1D943-6-5	3/8x19	5/16	2.13	54	22	1.22	31
1D943-6-6	3/8x19	3/8	2.13	54	22	1.22	31
1D943-8-6	1/2x14	3/8	2.36	60	27	1.22	31
1D943-8-8	1/2x14	1/2	2.44	62	27	1.10	28
1D943-12-12	3/4x14	3/4	2.76	70	32	1.18	30
1D943-16-16	1x11	1	3.23	82	41	1.38	35

**WARNING:** This product can expose you to chemicals including Lead, which is known to the State of California to cause cancer and birth defects or other reproductive harm. For more information go to [www.p65warnings.ca.gov](http://www.p65warnings.ca.gov).

# 19243

## Female BSP Parallel Pipe - Swivel - (60° Cone)

ISO 12151-6

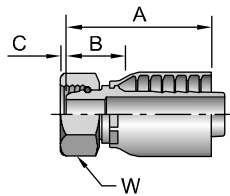

view on web page

# Part Number	Thread inch	Hose I.D. inch	A		C		W mm	B	
			inch	mm	inch	mm		inch	mm
19243-2-4	1/8x28	1/4	1.61	41	0.20	5	14	0.67	17
19243-4-4	1/4x19	1/4	1.95	50	0.22	6	19	1.20	30
19243-6-4	3/8x19	1/4	1.73	44	0.26	7	22	0.79	20
19243-6-6	3/8x19	3/8	2.35	60	0.26	7	22	1.32	34
19243-6-8	3/8x19	1/2	2.17	55	0.26	7	22	0.79	20
19243-8-6	1/2x14	3/8	2.01	51	0.28	7	27	0.87	22
19243-8-8	1/2x14	1/2	2.72	69	0.28	7	27	1.46	37
19243-10-8	5/8x14	1/2	2.80	71	0.37	9	30	1.54	39
19243-10-10	5/8x14	5/8	2.99	76	0.37	9	30	1.55	39
19243-12-10	3/4x14	5/8	3.11	79	0.35	9	36	1.67	42
19243-12-12	3/4x14	3/4	3.19	81	0.35	9	36	1.75	44
19243-16-16	1x11	1	3.67	93	0.44	11	41	2.05	52
19243-20-20	1-1/4x11	1-1/4	3.11	79	0.41	11	50	1.26	32

When measuring overall length to the end of the nut, B+C dimensions must be used to calculate cut-off allowance.

**WARNING:** This product can expose you to chemicals including Lead, which is known to the State of California to cause cancer and birth defects or other reproductive harm. For more information go to [www.p65warnings.ca.gov](http://www.p65warnings.ca.gov).



# 1B143

## Female BSP Parallel Pipe - Swivel - 45° Elbow - (60° Cone)

ISO 12151-6

# Part Number	Thread inch	Hose I.D. inch	A		E		W mm	B	
			inch	mm	inch	mm		inch	mm
1B143-4-4	1/4x19	1/4	2.26	57	0.61	15	19	1.51	38
1B143-6-6	3/8x19	3/8	2.61	66	0.67	17	22	1.59	40
1B143-8-8	1/2x14	1/2	3.10	78	0.79	20	27	1.85	46
1B143-10-10	5/8x14	5/8	3.53	89	0.91	23	30	2.08	52
1B143-12-10	3/4x14	5/8	3.47	88	0.87	22	32	2.02	51
1B143-12-12	3/4x14	3/4	3.77	95	0.98	24	32	2.34	59
1B143-16-16	1x11	1	4.72	119	1.22	30	41	3.10	78

When used in a port, a bonded seal must be used. See Accessories Section for more information.

**WARNING:** This product can expose you to chemicals including Lead, which is known to the State of California to cause cancer and birth defects or other reproductive harm. For more information go to [www.p65warnings.ca.gov](http://www.p65warnings.ca.gov).

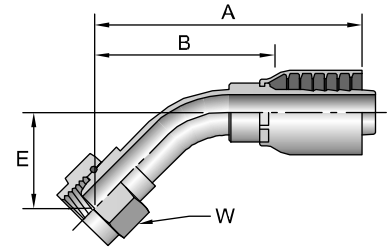

view on web page

# 1B243

## Female BSP Parallel Pipe - Swivel - 90° Elbow - (60° Cone)

ISO 12151-6

# Part Number	Thread inch	Hose I.D. inch	A		E		W mm	B	
			inch	mm	inch	mm		inch	mm
1B243-2-4	1/8x28	1/4	1.97	50	1.10	28	14	1.02	26
1B243-4-4	1/4x19	1/4	1.83	46	1.12	28	19	1.08	27
1B243-6-6	3/8x19	3/8	2.32	59	1.46	37	22	1.32	34
1B243-8-8	1/2x14	1/2	2.95	75	1.57	40	27	1.57	40
1B243-10-8	5/8x14	1/2	2.91	74	1.57	40	30	1.54	39
1B243-10-10	5/8x14	5/8	3.13	80	1.57	40	30	1.72	44
1B243-12-10	3/4x14	5/8	3.62	92	2.32	59	32	2.05	52
1B243-12-12	3/4x14	3/4	3.58	91	2.32	59	32	2.00	51
1B243-16-16	1x11	1	4.33	110	2.48	63	41	2.56	65
1B243-20-20	1-1/4x11	1-1/4	4.72	120	2.99	76	50	2.87	73

Metric S: Mates with EO "S" Series Fittings.

When measuring overall length to the end of the nut, B+C dimensions must be used to calculate cut-off allowance.

**WARNING:** This product can expose you to chemicals including Lead, which is known to the State of California to cause cancer and birth defects or other reproductive harm. For more information go to [www.p65warnings.ca.gov](http://www.p65warnings.ca.gov).

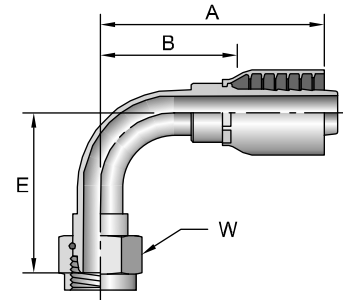

view on web page

# 1B443

## Female BSP Parallel Pipe - Swivel - 90° Elbow - Block Type - (60° Cone)

### Elbow - Block Type - (60° Cone)

ISO 228-1

# Part Number	Thread inch	Hose I.D. inch	A		E		H	W	B	
			inch	mm	inch	mm	mm	mm	inch	mm
1B443-4-4	1/4x19	1/4	2.40	61	1.14	29	17	19	1.40	36
1B443-6-6	3/8x19	3/8	2.76	70	1.02	26	19	22	1.42	36
1B443-8-8	1/2x14	1/2	3.19	81	1.02	26	22	27	1.57	40

**WARNING:** This product can expose you to chemicals including Lead, which is known to the State of California to cause cancer and birth defects or other reproductive harm. For more information go to [www.p65warnings.ca.gov](http://www.p65warnings.ca.gov).

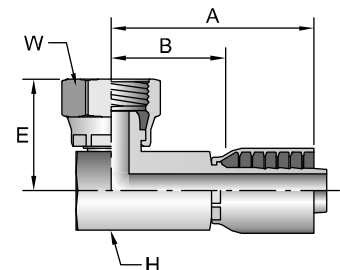

view on web page

Metric S: Mates with EO "S" Series Fittings.

# 1B543

## Female BSP Parallel Pipe - Swivel - (Flat Seat)

ISO 228-1

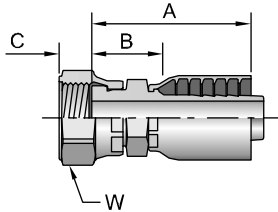

view on web page

# Part Number	Thread inch	Hose I.D. inch	A inch mm		C inch mm		W mm	B inch mm	
1B543-8-6	1/2x14	3/8	1.89	48	0.43	11	27	0.75	19
1B543-8-8	1/2x14	1/2	2.28	58	0.43	11	27	0.94	24

When measuring overall length to the end of the nut, B+C dimensions must be used to calculate cut-off allowance.

**WARNING:** This product can expose you to chemicals including Lead, which is known to the State of California to cause cancer and birth defects or other reproductive harm. For more information go to [www.p65warnings.ca.gov](http://www.p65warnings.ca.gov).

# 14943

## DIN Metric Banjo

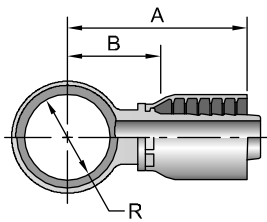

view on web page

# Part Number	R mm	Hose I.D. inch	A inch mm		B inch mm	
14943-10-4	10	1/4	1.85	47	0.94	24
14943-12-4	12	1/4	1.85	47	0.98	25
14943-14-5	14	5/16	2.01	51	1.06	27
14943-16-6	16	3/8	2.28	58	1.14	29
14943-18-8	18	1/2	2.60	66	1.22	31
14943-22-10	22	5/8	2.91	74	1.38	35
14943-26-12	26	3/4	3.07	78	1.54	39

**WARNING:** This product can expose you to chemicals including Lead, which is known to the State of California to cause cancer and birth defects or other reproductive harm. For more information go to [www.p65warnings.ca.gov](http://www.p65warnings.ca.gov).

## AM Banjo Bolt w/DIN Metric Thread

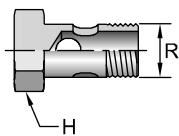

# Part Number	R Thread mm	H mm	Copper Washer 2
AM-03	8	M8x1	853009-8
AM-04	10	M10x1	853009-10
AM-06	12	M12x1,5	853009-12
AM-08	14	M14x1,5	853009-14
AM-10	16	M16x1,5	853009-16
AM-13	18	M18x1,5	853009-18
AM-16	22	M22x1,5	853009-22
AM-20	26	M26x1,5	853009-26
AM-30	30	M30x1,5	853009-30

Two (2) copper washers per bolt must be ordered separately.

**WARNING:** This product can expose you to chemicals including Lead, which is known to the State of California to cause cancer and birth defects or other reproductive harm. For more information go to [www.p65warnings.ca.gov](http://www.p65warnings.ca.gov).

Metric S: Mates with EO "S" Series Fittings.

## 1MU43 Female Metric - Swivel - (30° Flare)

# Part Number	Thread mm	Hose I.D. inch	A		H mm	W mm	B	
			inch	mm			inch	mm
1MU43-4-4	M14x1,5	1/4	2.07	53	19	19	1.32	34
1MU43-6-4	M18x1,5	1/4	2.18	55	24	24	1.43	36
1MU43-6-6	M18x1,5	3/8	2.45	62	24	24	1.42	36
1MU43-8-8	M22x1,5	1/2	2.84	72	27	27	1.58	40

Japanese Fittings - Female Swivel 30° Flare with Metric Threads. All 30° flared fitting sizes are available by combining the 1MU43 fittings in sizes up to -8 with the 1XU43 fittings in sizes -10 and larger.

**WARNING:** This product can expose you to chemicals including Lead, which is known to the State of California to cause cancer and birth defects or other reproductive harm. For more information go to [www.p65warnings.ca.gov](http://www.p65warnings.ca.gov).

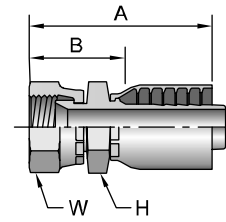

[view on web page](#)

## 1XU43 Female Metric - Swivel - (30° Flare)

# Part Number	Thread mm	Hose I.D. inch	A		H mm	W mm	B	
			inch	mm			inch	mm
1XU43-10-10	M24x1,5	5/8	3.25	83	30	32	1.81	46
1XU43-12-12	M30x1,5	3/4	3.40	86	32	36	1.96	50
1XU43-16-16	M33x1,5	1	4.03	102	36	41	2.41	61

Japanese Fittings - Female Swivel 30° Flare with Metric Threads. All 30° flared fitting sizes are available by combining the 1MU43 fittings in sizes up to -8 with the 1XU43 fittings in sizes -10 and larger.

**WARNING:** This product can expose you to chemicals including Lead, which is known to the State of California to cause cancer and birth defects or other reproductive harm. For more information go to [www.p65warnings.ca.gov](http://www.p65warnings.ca.gov).

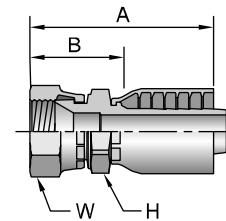

[view on web page](#)

## 1FU43 Female BSP Parallel Pipe - Swivel - (30° Flare) B8363 Code F

# Part Number	Thread inch	Hose I.D. inch	A		H mm	W mm	B	
			inch	mm			inch	mm
1FU43-4-4	1/4x19	1/4	1.90	48	19	19	1.15	29
1FU43-6-6	3/8x19	3/8	2.32	59	22	22	1.29	33
1FU43-8-8	1/2x14	1/2	2.66	68	27	27	1.40	36
1FU43-12-12	3/4x14	3/4	3.06	78	36	36	1.62	41
1FU43-16-16	1x11	1	3.53	90	41	41	1.91	49
1FU43-20-20	1-1/4x11	1-1/4	3.87	98	50	50	2.18	55

**WARNING:** This product can expose you to chemicals including Lead, which is known to the State of California to cause cancer and birth defects or other reproductive harm. For more information go to [www.p65warnings.ca.gov](http://www.p65warnings.ca.gov).

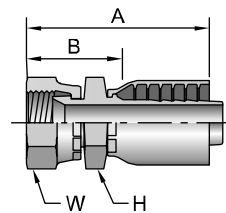

[view on web page](#)

# 1UT43

## Male BSP Taper Pipe - Rigid - (60° Cone)

B8363 Code R

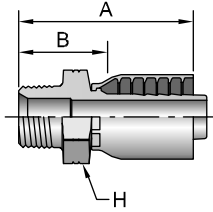

view on web page

# Part Number	Thread inch	Hose I.D. inch	A		H mm	B	
			inch	mm	mm	inch	mm
1UT43-4-4	1/4x19	1/4	1.92	49	19	1.17	30
1UT43-6-6	3/8x19	3/8	2.25	57	22	1.22	31
1UT43-8-8	1/2x14	1/2	2.68	68	27	1.42	36
1UT43-12-12	3/4x14	3/4	2.96	75	36	1.53	39
1UT43-16-16	1x11	1	3.48	88	41	1.86	47
1UT43-20-20	1-1/4x11	1-1/4	3.75	95	50	2.10	53

**WARNING:** This product can expose you to chemicals including Lead, which is known to the State of California to cause cancer and birth defects or other reproductive harm. For more information go to [www.p65warnings.ca.gov](http://www.p65warnings.ca.gov).

# 1GU43

## Female BSP Parallel Pipe - Swivel - (60° Cone)

B8363 Code C

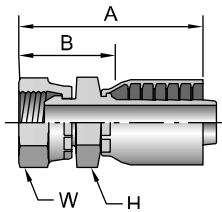

view on web page

# Part Number	Thread inch	Hose I.D. inch	A		H mm	W mm	B	
			inch	mm	mm	mm	inch	mm
1GU43-4-4	1/4x19	1/4	2.08	53	19	19	1.33	34
1GU43-6-6	3/8x19	3/8	2.45	62	22	22	1.42	36
1GU43-8-8	1/2x14	1/2	2.81	71	27	27	1.56	40
1GU43-12-12	3/4x14	3/4	3.24	82	36	36	1.81	46
1GU43-16-16	1x11	1	3.74	95	41	41	2.12	54
1GU43-20-20	1-1/4x11	1-1/4	4.07	103	50	50	2.38	60

**WARNING:** This product can expose you to chemicals including Lead, which is known to the State of California to cause cancer and birth defects or other reproductive harm. For more information go to [www.p65warnings.ca.gov](http://www.p65warnings.ca.gov).



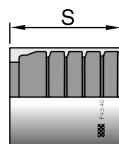







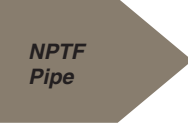
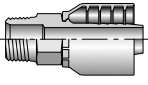

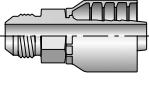
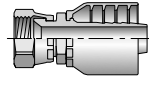
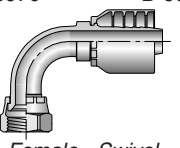

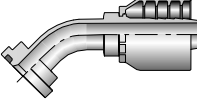
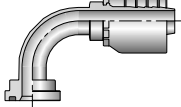
# 43 Series Crimp Shell

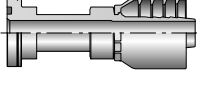
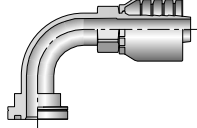

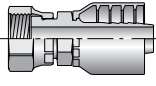
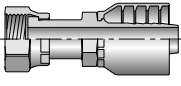
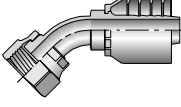
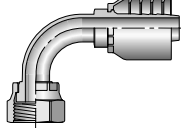
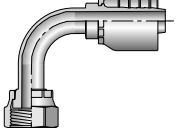
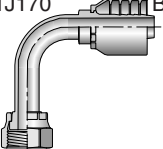
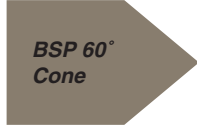
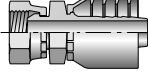
# Part Number	Hose I.D. inch	S	
		inch	mm
10043-40	2-1/2	2.63	66,8
10043-48	3	2.95	75,0

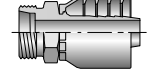
-40 size sold as a two piece fitting. Approved for 187 Hose only.

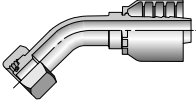
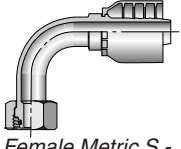
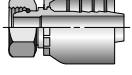
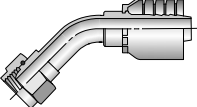
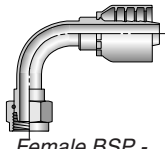
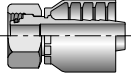
**WARNING:** This product can expose you to chemicals including Lead, which is known to the State of California to cause cancer and birth defects or other reproductive harm. For more information go to [www.p65warnings.ca.gov](http://www.p65warnings.ca.gov).

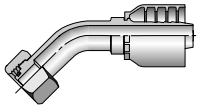
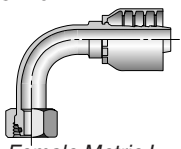
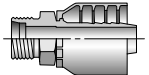
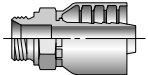
 <b>NPTF Pipe</b>	10170 B-66  <i>Male - Rigid</i>	 <b>JIC 37°</b>	10370 B-66  <i>Male - Rigid</i>	10670 B-66  <i>Female - Swivel</i>	13970 B-66  <i>Female - Swivel 90° Elbow - Short</i>
 <b>Code 61 Flange</b>	11770 B-67  <i>45° Elbow</i>	11970 B-67  <i>90° Elbow</i>	 <b>Code 62 Flange</b>	16A70 B-67  <i>Flange Head</i>	16N70 B-68  <i>90° Elbow</i>
 <b>Seal-Lok® (O-Ring Face Seal)</b>	1JC70 B-68  <i>Female - Swivel Short</i>	1JS70 B-68  <i>Female - Swivel Long</i>	1J770 B-68  <i>Femal - Swivel 45° Elbow</i>	1J970 B-69  <i>Female - Swivel 90° Elbow - Short</i>	1J570 B-69  <i>Female - Swivel 90° Elbow - Medium</i>
1J170 B-69  <i>Female - Swivel 90° Elbow - Long</i>	 <b>BSP 60° Cone</b>	1GU70 B-70  <i>Female - Swivel</i>	 <b>French Gaz</b>	1FG70 B-70  <i>Male - Rigid</i>	 <b>Metric</b>
10C70 B-70  <i>Female Metric S - Swivel - 45° Elbow</i>	11C70 B-71  <i>Female Metric S - Swivel - 90° Elbow</i>	19270 B-71  <i>Female BSP - Swivel - 60° Cone</i>	1B170 B-71  <i>Female BSP - Swivel - 45° Elbow</i>	1B270 B-72  <i>Female BSP - Swivel - 90° Elbow</i>	1C970 B-72  <i>Female - Swivel</i>
1CA70 B-72  <i>Female Metric L - Swivel - 24° Cone</i>	1CE70 B-73  <i>Female Metric L - Swivel - 45° Elbow</i>	1CF70 B-73  <i>Female Metric L - Swivel - 90° Elbow</i>	1D270 B-73  <i>Male Metric S - Rigid</i>	1D970 B-73  <i>Male - BSP - Rigid</i>	

A

B

C

D

E

### 10170 Male NPTF Pipe - Rigid

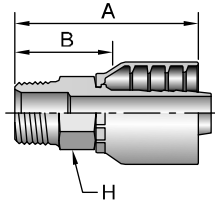

view on web page

# Part Number	Thread		Hose I.D.		A		H		B	
	inch		inch		inch	mm	inch		inch	mm
10170-6-6	3/8x18		3/8		2.37	60	3/4		1.47	37
10170-8-8	1/2x14		1/2		2.84	72	7/8		1.40	36

**WARNING:** This product can expose you to chemicals including Lead, which is known to the State of California to cause cancer and birth defects or other reproductive harm. For more information go to [www.p65warnings.ca.gov](http://www.p65warnings.ca.gov).

### 10370 Male JIC 37° - Rigid

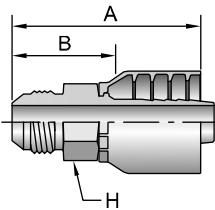

view on web page

# Part Number	Thread		Hose I.D.		A		H		B	
	inch		inch		inch	mm	inch		inch	mm
10370-8-8	1/2	3/4x16	1/2		2.68	68	7/8		1.47	37
10370-10-8	5/8	7/8x14	1/2		2.62	66	15/16		1.41	36

**WARNING:** This product can expose you to chemicals including Lead, which is known to the State of California to cause cancer and birth defects or other reproductive harm. For more information go to [www.p65warnings.ca.gov](http://www.p65warnings.ca.gov).

### 10670 Female JIC 37° - Swivel

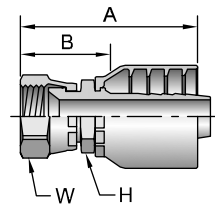

view on web page

# Part Number	Thread		Hose I.D.		A		H	W	B	
	inch		inch		inch	mm	inch	inch	inch	mm
10670-6-6	3/8	9/16x18	3/8		2.29	58	11/16	11/16	1.39	35
10670-8-8	1/2	3/4x16	1/2		2.62	67	13/16	7/8	1.41	36
10670-10-8	5/8	7/8x14	1/2		2.85	72	7/8	1	1.64	42
10670-10-10	5/8	7/8x14	5/8		2.84	72	15/16	1	1.59	40

**WARNING:** This product can expose you to chemicals including Lead, which is known to the State of California to cause cancer and birth defects or other reproductive harm. For more information go to [www.p65warnings.ca.gov](http://www.p65warnings.ca.gov).

### 13970 Female JIC 37° - Swivel - 90° Elbow - Short Drop

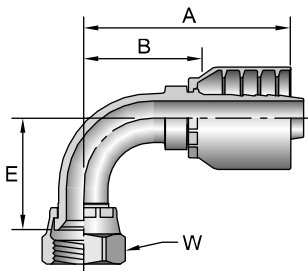

view on web page

# Part Number	Thread		Hose I.D.		A		E		W		B	
	inch		inch		inch	mm	inch	mm	inch	inch	mm	
13970-8-8	1/2	3/4x16	1/2		2.62	67	1.14	29	7/8	1.41	36	

**WARNING:** This product can expose you to chemicals including Lead, which is known to the State of California to cause cancer and birth defects or other reproductive harm. For more information go to [www.p65warnings.ca.gov](http://www.p65warnings.ca.gov).

# 11770

## SAE Code 61 Flange Head - 45° Elbow

ISO 12151-3 - 45S - L

# Part Number	Flange inch	Hose I.D. inch	A		E		F inch	B	
			inch	mm	inch	mm		inch	mm
11770-8-8	1/2	1/2	3.28	83	0.77	20	1-3/16	2.07	53

**WARNING:** This product can expose you to chemicals including Lead, which is known to the State of California to cause cancer and birth defects or other reproductive harm. For more information go to [www.p65warnings.ca.gov](http://www.p65warnings.ca.gov).

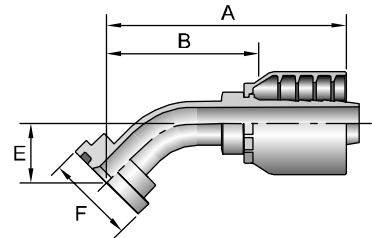

[view on web page](#)

# 11970

## SAE Code 61 Flange Head - 90° Elbow

ISO 12151-3 - E90S - L

# Part Number	Flange inch	Hose I.D. inch	A		E		F inch	B	
			inch	mm	inch	mm		inch	mm
11970-8-8	1/2	1/2	2.93	74	1.60	41	1-3/16	1.72	44
11970-12-10	3/4	5/8	3.54	90	2.02	51	1-1/2	2.29	58

**WARNING:** This product can expose you to chemicals including Lead, which is known to the State of California to cause cancer and birth defects or other reproductive harm. For more information go to [www.p65warnings.ca.gov](http://www.p65warnings.ca.gov).

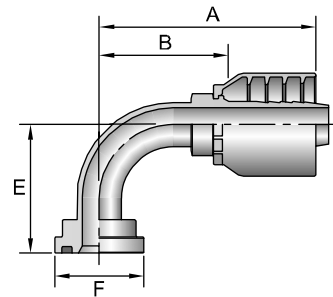

[view on web page](#)

# 16A70

## SAE Code 62 Flange Head

ISO 12151-3 - S - S

# Part Number	Flange inch	Hose I.D. inch	A		F inch	B	
			inch	mm		inch	mm
16A70-8-8	1/2	1/2	3.50	88,9	1-1/4	2.29	56,9

**WARNING:** This product can expose you to chemicals including Lead, which is known to the State of California to cause cancer and birth defects or other reproductive harm. For more information go to [www.p65warnings.ca.gov](http://www.p65warnings.ca.gov).

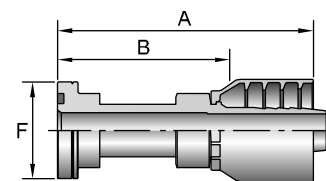

[view on web page](#)

# 16N70

## SAE Code 62 Flange Head - 90° Elbow

ISO 12151-3 - E90S - S ( 1 Piece: ISO 12151-3 - E90M - S)

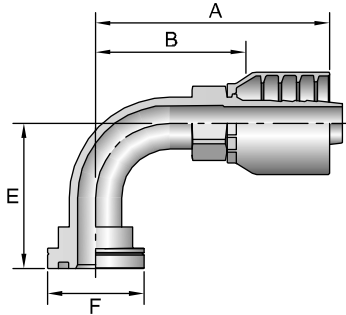

view on web page

#			A		E			B	
Part Number	Flange inch	Hose I.D. inch	inch	mm	inch	mm	inch	inch	mm
16N70-8-8	1/2	1/2	2.60	66	1.61	41	1-1/4	1.34	34

**WARNING:** This product can expose you to chemicals including Lead, which is known to the State of California to cause cancer and birth defects or other reproductive harm. For more information go to [www.p65warnings.ca.gov](http://www.p65warnings.ca.gov).

# 1JC70

## Female Seal-Lok® - Swivel - Short

ISO 12151- 1 - SWSA

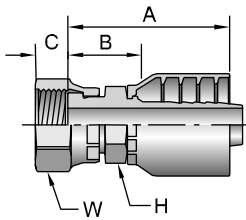

view on web page

#			A		C				B	
Part Number	Thread inch	Hose I.D. inch	inch	mm	inch	mm	inch	inch	inch	mm
1JC70-6-6	3/8 11/16x16	3/8	1.94	49	0.34	9	11/16	13/16	1.04	26
1JC70-8-6	1/2 13/16x16	3/8	2.00	51	0.43	11	13/16	15/16	1.10	28
1JC70-8-8	1/2 13/16x16	1/2	2.22	56	0.43	11	13/16	15/16	1.01	26
1JC70-10-10	5/8 1x14	5/8	2.40	61	0.53	13	15/16	1-1/8	1.15	29

**WARNING:** This product can expose you to chemicals including Lead, which is known to the State of California to cause cancer and birth defects or other reproductive harm. For more information go to [www.p65warnings.ca.gov](http://www.p65warnings.ca.gov).

# 1JS70

## Female Seal-Lok® - Swivel - Long

ISO 12151-1 - SWSB

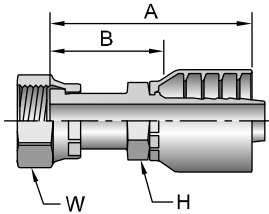

view on web page

#			A				B	
Part Number	Thread inch	Hose I.D. inch	inch	mm	inch	inch	inch	mm
1JS70-6-6	3/8 11/16x16	3/8	2.28	58	11/16	13/16	1.38	35
1JS70-8-8	1/2 13/16x16	1/2	2.65	67	13/16	15/16	1.44	37
1JS70-12-8	3/4 1-3/16x12	1/2	2.90	74	1-1/8	1-3/8	1.69	43
1JS70-12-10	3/4 1-3/16x12	5/8	3.10	79	1-1/8	1-3/8	1.85	47

**WARNING:** This product can expose you to chemicals including Lead, which is known to the State of California to cause cancer and birth defects or other reproductive harm. For more information go to [www.p65warnings.ca.gov](http://www.p65warnings.ca.gov).

See Accessories Section for O-Rings and Flange Kits.



# 1J770

## Female Seal-Lok® - Swivel - 45° Elbow

ISO 12151-1 - SWE45

# Part Number	Thread		Hose I.D. inch	A		E		W inch	B	
	inch	1x14		inch	mm	inch	mm		inch	mm
1J770-10-10	5/8	1x14	5/8	3.08	78	0.63	16	1-1/8	1.83	46

**WARNING:** This product can expose you to chemicals including Lead, which is known to the State of California to cause cancer and birth defects or other reproductive harm. For more information go to [www.p65warnings.ca.gov](http://www.p65warnings.ca.gov).

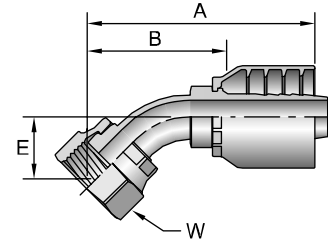

[view on web page](#)

# 1J970

## Female Seal-Lok® - Swivel - 90° Elbow - Short Drop

ISO 12151-1 - SWES90

# Part Number	Thread		Hose I.D. inch	A		E		W inch	B	
	inch	13/16x16		inch	mm	inch	mm		inch	mm
1J970-8-8	1/2	13/16x16	1/2	2.59	66	1.14	29	15/16	1.38	35
1J970-12-8	3/4	1-3/16x12	1/2	3.21	82	1.88	48	1-3/8	2.00	51

**WARNING:** This product can expose you to chemicals including Lead, which is known to the State of California to cause cancer and birth defects or other reproductive harm. For more information go to [www.p65warnings.ca.gov](http://www.p65warnings.ca.gov).

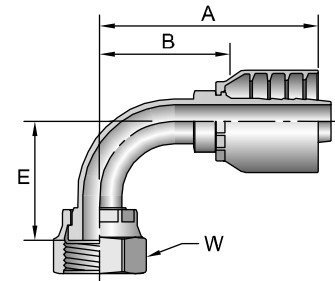

[view on web page](#)

# 1J570

## Female Seal-Lok® - Swivel - 90° Elbow - Medium Drop

ISO 12151-1 - SWEM90

# Part Number	Thread		Hose I.D. inch	A		E		W inch	B	
	inch	1x14		inch	mm	inch	mm		inch	mm
1J570-10-10	5/8	1x14	5/8	2.88	73	1.85	47	1-1/8	1.63	41

**WARNING:** This product can expose you to chemicals including Lead, which is known to the State of California to cause cancer and birth defects or other reproductive harm. For more information go to [www.p65warnings.ca.gov](http://www.p65warnings.ca.gov).

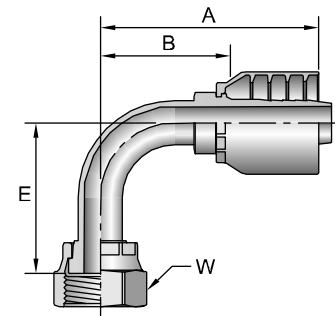

[view on web page](#)

# 1J170

## Female Seal-Lok® - Swivel - 90° Elbow - Long Drop

ISO 12151-1 - SWEL90

# Part Number	Thread		Hose I.D. inch	A		E		W inch	B	
	inch	1x14		inch	mm	inch	mm		inch	mm
1J170-10-10	5/8	1x14	5/8	2.88	73	2.76	70	1-1/8	1.63	41

**WARNING:** This product can expose you to chemicals including Lead, which is known to the State of California to cause cancer and birth defects or other reproductive harm. For more information go to [www.p65warnings.ca.gov](http://www.p65warnings.ca.gov).

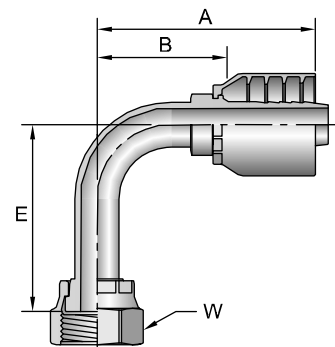

[view on web page](#)

See Accessories Section for O-Rings and Flange Kits.

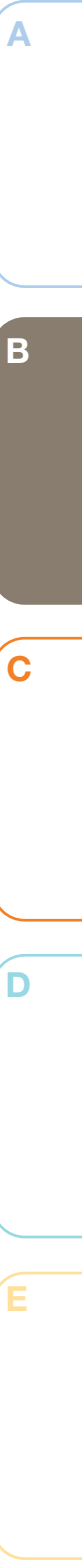

# 1GU70

## Female BSP Parallel Pipe - Swivel - (60° Cone)

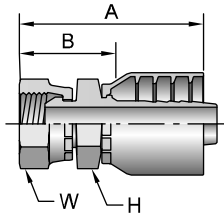

# Part Number	Thread Inch	Hose I.D. inch	A		H	W	B	
			inch	mm	mm	inch	inch	mm
1GU70-8-8	1/2x14	1/2	2.82	72	27	NA	1.61	41

**WARNING:** This product can expose you to chemicals including Lead, which is known to the State of California to cause cancer and birth defects or other reproductive harm. For more information go to [www.p65warnings.ca.gov](http://www.p65warnings.ca.gov).

# 1FG70

## Male French Gaz Series - Rigid - (24° Cone)

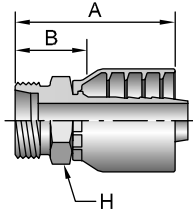

# Part Number	Thread mm	Hose I.D. inch	A		H		B	
			inch	mm	inch	mm	inch	mm
1FG70-21-10	21 M30x1,5	5/8	2.87	73	1.18	30	1.62	41

**WARNING:** This product can expose you to chemicals including Lead, which is known to the State of California to cause cancer and birth defects or other reproductive harm. For more information go to [www.p65warnings.ca.gov](http://www.p65warnings.ca.gov).

view on web page

# 10C70

## Female Metric S - Swivel - 45° Elbow - (24° Cone with O-Ring) ISO 12151-2 - SWE45

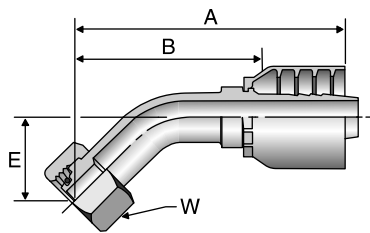

# Part Number	Thread mm	Hose I.D. inch	A		E		W	B	
			inch	mm	inch	mm	mm	inch	mm
10C70-12-6	12 M20x1,5	3/8	2.72	69	0.79	20	24	1.57	40
10C70-16-8	16 M24x1,5	1/2	3.27	83	0.94	24	30	1.89	48
10C70-20-10	20 M30x2	5/8	3.58	91	0.98	25	36	2.05	52

**WARNING:** This product can expose you to chemicals including Lead, which is known to the State of California to cause cancer and birth defects or other reproductive harm. For more information go to [www.p65warnings.ca.gov](http://www.p65warnings.ca.gov).

view on web page

# 11C70

## Female Metric S - Swivel - 90° Elbow - (24° Cone with O-Ring) ISO 12151-2 - SWE

# Part Number	Thread mm	Hose I.D. inch	A		E		W mm	B	
			inch	mm	inch	mm		inch	mm
11C70-12-6	12 M20X1,5	3/8	2.64	67	1.46	37	24	1.50	38
11C70-20-10	20 M30X2	5/8	3.11	79	1.89	48	36	1.57	40

**WARNING:** This product can expose you to chemicals including Lead, which is known to the State of California to cause cancer and birth defects or other reproductive harm. For more information go to [www.p65warnings.ca.gov](http://www.p65warnings.ca.gov).

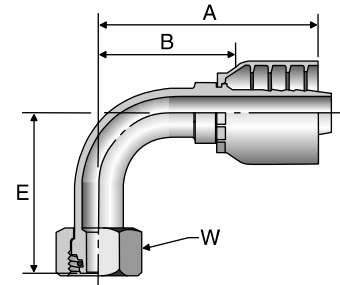

view on web page

# 19270

## Female BSP Parallel Pipe - Swivel - (60° Cone) ISO 228-1

# Part Number	Thread inch	Hose I.D. inch	A		C		W mm	B	
			inch	mm	inch	mm		inch	mm
19270-8-8	1/2x14	1/2	2.24	57	0.28	7	27	0.87	22
19270-10-10	5/8x14	5/8	2.24	57	0.35	9	30	0.83	21
19270-12-10	3/4x14	5/8	2.40	61	0.35	9	32	0.87	22

**WARNING:** This product can expose you to chemicals including Lead, which is known to the State of California to cause cancer and birth defects or other reproductive harm. For more information go to [www.p65warnings.ca.gov](http://www.p65warnings.ca.gov).

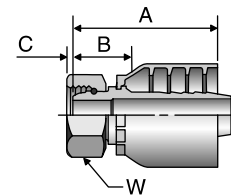

view on web page

# 1B170

## Female BSP Parallel pipe - Swivel- 45° Elbow - (60° Cone) ISO 228-1

# Part Number	Thread inch	Hose I.D. inch	A		E		W mm	B	
			inch	mm	inch	mm		inch	mm
1B170-8-8	1/2x14	1/2	3.11	79	0.79	20	27	1.77	45

**WARNING:** This product can expose you to chemicals including Lead, which is known to the State of California to cause cancer and birth defects or other reproductive harm. For more information go to [www.p65warnings.ca.gov](http://www.p65warnings.ca.gov).

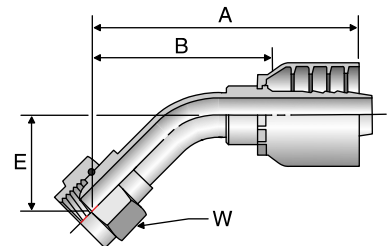

view on web page

## 1B270

Female BSP Parallel Pipe - Swivel - 90° Elbow - (60° Cone)  
ISO 228-1

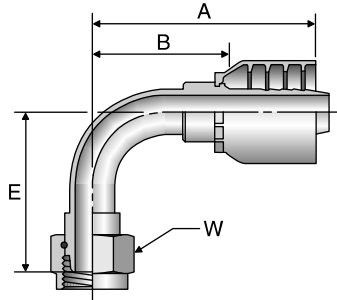

# Part Number	Thread inch	Hose I.D. inch	A		E		W mm	B	
			inch	mm	inch	mm		inch	mm
1B270-8-8	1/2x14	1/2	2.76	70	1.54	39	27	1.38	35
1B270-10-10	5/8x14	5/8	3.07	78	1.81	46	30	1.61	41
1B270-12-10	3/4x14	5/8	3.19	81	1.65	42	32	1.61	41

**WARNING:** This product can expose you to chemicals including Lead, which is known to the State of California to cause cancer and birth defects or other reproductive harm. For more information go to [www.p65warnings.ca.gov](http://www.p65warnings.ca.gov).

view on web page

## 1C970

Female Metric S - Swivel - (24° Cone with O-Ring)

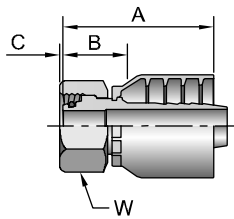

# Part Number	Thread mm		Hose I.D. inch	A		C		W mm	B	
	mm	mm		inch	mm	inch	mm		inch	mm
1C970-12-6	12	M20x1,5	3/8	2.03	52	0.03	1	24	1.13	29
1C970-16-8	16	M24x1,5	1/2	2.31	59	0.09	2	30	1.10	28
1C970-20-10	20	M30x2	5/8	2.51	64	0.05	1	36	1.26	32

When measuring overall length to end of nut, B + C dimensions must be used to calculate cut-off allowance.

**WARNING:** This product can expose you to chemicals including Lead, which is known to the State of California to cause cancer and birth defects or other reproductive harm. For more information go to [www.p65warnings.ca.gov](http://www.p65warnings.ca.gov).

view on web page

## 1CA70

Female Metric L - Swivel - (24° Cone with O-Ring)

ISO 12151-2 - SWS

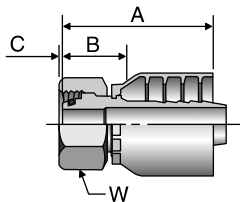

# Part Number	Thread mm		Hose I.D. inch	A		C		W mm	B	
	mm	mm		inch	mm	inch	mm		inch	mm
1CA70-12-6	12	M18x1,5	3/8	2.09	53	0.04	1	22	0.94	24
1CA70-15-8	15	M22x1,5	1/2	2.09	62	0.07	2	22	0.94	27
1CA70-18-10	18	M26x1,5	5/8	2.44	62	0.02	0.5	32	1.02	26

**WARNING:** This product can expose you to chemicals including Lead, which is known to the State of California to cause cancer and birth defects or other reproductive harm. For more information go to [www.p65warnings.ca.gov](http://www.p65warnings.ca.gov).

view on web page

### 1CE70

**Female Metric L - Swivel - 45° Elbow - (24° Cone with O-Ring)**  
 ISO 12151-2 - SWE45

# Part Number	Thread mm	Hose I.D. inch	A		E		W mm	B	
			inch	mm	inch	mm		inch	mm
1CE70-18-10	18 M26x1,5	5/8	3.58	91	0.98	25	32	2.05	52

**WARNING:** This product can expose you to chemicals including Lead, which is known to the State of California to cause cancer and birth defects or other reproductive harm. For more information go to [www.p65warnings.ca.gov](http://www.p65warnings.ca.gov).

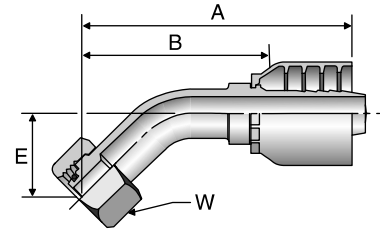

[view on web page](#)

### 1CF70

**Female Metric L - Swivel - 90° Elbow - (24° Cone with O-Ring)**  
 ISO 12151-2 - SWE

# Part Number	Thread mm	Hose I.D. inch	A		E		W mm	B	
			inch	mm	inch	mm		inch	mm
1CF70-15-8	15 M22x1,5	1/2	2.91	74	1.77	45	27	1.54	39
1CF70-18-10	18 M26x1,5	5/8	3.11	79	1.93	49	32	1.65	42

**WARNING:** This product can expose you to chemicals including Lead, which is known to the State of California to cause cancer and birth defects or other reproductive harm. For more information go to [www.p65warnings.ca.gov](http://www.p65warnings.ca.gov).

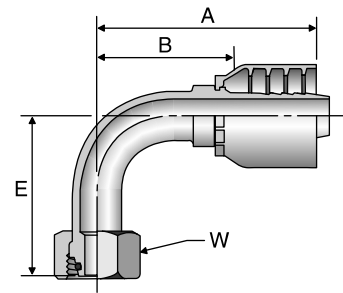

[view on web page](#)

### 1D270

**Male Metric S - Rigid - (24° Cone)**  
 ISO 12151-2

# Part Number	Thread mm	Hose I.D. inch	A		H mm	B	
			inch	mm		inch	mm
1D270-16-8	16 M24x1,5	1/2	2.44	62	24	1.10	28
1D270-20-10	20 M30x2	5/8	2.95	75	30	1.26	32

**WARNING:** This product can expose you to chemicals including Lead, which is known to the State of California to cause cancer and birth defects or other reproductive harm. For more information go to [www.p65warnings.ca.gov](http://www.p65warnings.ca.gov).

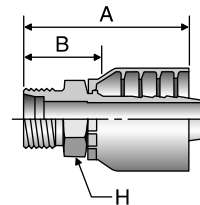

[view on web page](#)

### 1D970

**Male BSP Parallel Pipe - Rigid - (60° Cone)**  
 ISO 228-1

# Part Number	Thread inch	Hose I.D. inch	A		H mm	B	
			inch	mm		inch	mm
1D970-8-8	1/2x14	1/2	2.44	62	27	1.10	28

**WARNING:** This product can expose you to chemicals including Lead, which is known to the State of California to cause cancer and birth defects or other reproductive harm. For more information go to [www.p65warnings.ca.gov](http://www.p65warnings.ca.gov).

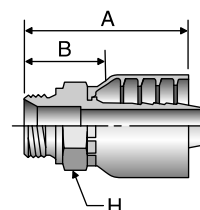

[view on web page](#)

*Notes*











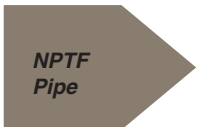
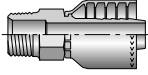

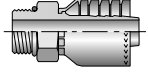

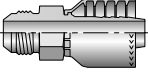
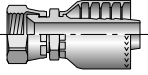
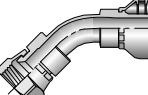
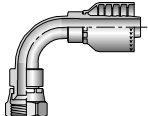
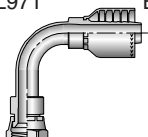
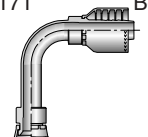

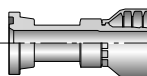
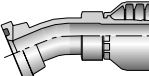
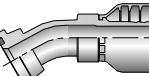
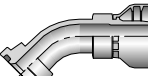

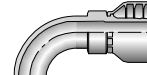
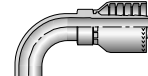
A

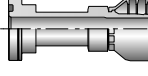
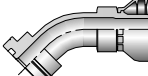
B

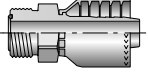
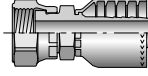
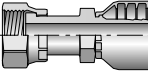
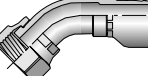
C

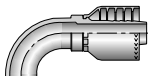
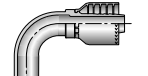
D

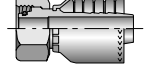
E

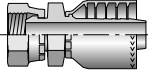
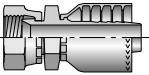
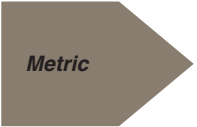
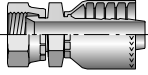
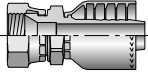
 <b>NPTF Pipe</b>	10171 B-76  <i>Male - Rigid</i>	 <b>SAE</b>	10571 B-76  <i>Male - Rigid</i>	 <b>JIC</b>	10371 B-76  <i>Male - Rigid</i>
10671 B-77  <i>Female - Swivel</i>	13771 B-77  <i>Female - Swivel 45° Elbow - Short</i>	13971 B-78  <i>Female - Swivel 90° Elbow - Short</i>	1L971 B-78  <i>Female - Swivel 90° Elbow - Medium</i>	14171 B-78  <i>Female - Swivel 90° Elbow - Long</i>	 <b>Code 61 Flange</b>
11571 B-79  <i>Flange</i>	11671 B-79  <i>22-1/2° Elbow</i>	12671 B-80  <i>30° Elbow</i>	11771 B-80  <i>45° Elbow</i>	12771 B-81  <i>60° Elbow</i>	11871 B-81  <i>67-1/2° Elbow</i>
11971 B-82  <i>90° Elbow</i>	18971 B-83  <i>90° Elbow-Long</i>	 <b>Code 62 Flange</b>	16A71 B-83  <i>Flange</i>	16F71 B-84  <i>45° Elbow</i>	16N71 B-84  <i>90° Elbow</i>
 <b>Seal-Lok® (O-Ring Face Seal)</b>	1J071 B-84  <i>Male - Rigid</i>	1JC71 B-85  <i>Female - Swivel Short</i>	1JS71 B-85  <i>Female - Swivel Long</i>	1J771 B-86  <i>Female - Swivel 45° Elbow</i>	1J971 B-86  <i>Female - Swivel 90° Elbow - Short</i>
1J571 B-87  <i>Female - Swivel 90° Elbow - Medium</i>	1J171 B-87  <i>Female - Swivel 90° Elbow - Long</i>	 <b>Metric "S"</b>	1C971 B-88  <i>Female - Swivel</i>	 <b>BSP</b>	1GU71 B-88  <i>Female - Swivel</i>
1FU71 B-89  <i>Female - Swivel</i>	 <b>Metric</b>	1MU71 B-89  <i>Female - Swivel</i>	1XU71 B-89  <i>Female - Swivel</i>		

A

B

C

D

E

### 10171 Male NPTF Pipe - Rigid

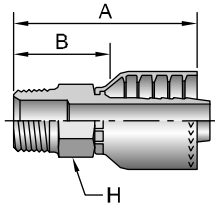

view on web page

# Part Number	Thread inch	Hose I.D. inch	A		H inch	B	
			inch	mm		inch	mm
10171-6-6	3/8x18	3/8	2.36	60	3/4	1.47	37
10171-8-8	1/2x14	1/2	2.82	72	7/8	1.63	41
10171-12-8	3/4x14	1/2	2.67	68	1-1/16	1.47	37
10171-12-12	3/4x14	3/4	3.08	78	1-1/16	1.71	43
10171-16-12	1x11-1/2	3/4	3.08	78	1-3/8	1.72	44
10171-16-16	1x11-1/2	1	3.63	92	1-3/8	2.04	52
10171-20-16	1-1/4x11-1/2	1	3.49	89	1-11/16	1.90	48
10171-20-20	1-1/4x11-1/2	1-1/4	4.06	103	1-3/4	2.39	61
10171-24-24	1-1/2x11-1/2	1-1/2	4.32	110	2	2.19	56
10171-32-32	2x11-1/2	2	4.72	118	2-1/2	2.52	64

**WARNING:** This product can expose you to chemicals including Lead, which is known to the State of California to cause cancer and birth defects or other reproductive harm. For more information go to [www.p65warnings.ca.gov](http://www.p65warnings.ca.gov).

### 10571 Male SAE Straight Thread with O-Ring - Rigid

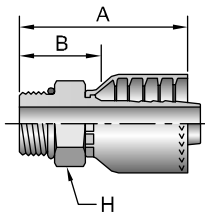

view on web page

# Part Number	Thread inch		Hose I.D. inch	A		H inch	B	
	inch	mm		inch	mm		inch	mm
10571-8-8	1/2	3/4x16	1/2	2.44	62	7/8	1.25	32
10571-12-12	3/4	1-1/16x12	3/4	2.79	71	1-1/4	1.43	36
10571-16-16	1	1-5/16x12	1	3.42	87	1-1/2	1.77	45
10571-20-20	1-1/4	1-5/8x12	1-1/4	3.67	93	1-7/8	2.00	51

**WARNING:** This product can expose you to chemicals including Lead, which is known to the State of California to cause cancer and birth defects or other reproductive harm. For more information go to [www.p65warnings.ca.gov](http://www.p65warnings.ca.gov).

### 10371 Male JIC 37° - Rigid

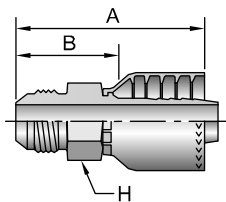

view on web page

# Part Number	Thread inch		Hose I.D. inch	A		H inch	B	
	inch	mm		inch	mm		inch	mm
10371-6-6	3/8	9/16x18	3/8	2.44	62	3/4	1.55	39
10371-8-6	1/2	3/4x16	3/8	2.29	58	7/8	1.40	36
10371-8-8	1/2	3/4x16	1/2	2.66	68	7/8	1.41	36
10371-10-8	5/8	7/8x14	1/2	2.60	66	15/16	1.41	36
10371-10-10	5/8	7/8x14	5/8	2.93	74	15/16	1.69	43
10371-12-12	3/4	1-1/16x12	3/4	3.17	80	1-1/8	1.81	46
10371-14-12	7/8	1-3/16x12	3/4	3.09	78	1-1/4	1.73	44
10371-16-12	1	1-5/16x12	3/4	3.02	77	1-3/8	1.66	42
10371-16-16	1	1-5/16x12	1	3.68	93	1-3/8	2.03	52
10371-20-16	1-1/4	1-5/8x12	1	3.43	87	1-7/8	1.84	47
10371-20-20	1-1/4	1-5/8x12	1-1/4	3.94	100	1-7/8	2.27	58

**WARNING:** This product can expose you to chemicals including Lead, which is known to the State of California to cause cancer and birth defects or other reproductive harm. For more information go to [www.p65warnings.ca.gov](http://www.p65warnings.ca.gov).



# 10671

## Female JIC 37° - Swivel

# Part Number	Thread		Hose I.D. inch	A		H inch	W inch	B		Additional Material Stainless Steel (C)
	inch	9/16x18		inch	mm			inch	mm	
10671-6-6	3/8	9/16x18	3/8	2.28	58	11/16	11/16	1.39	35	
10671-8-6	1/2	3/4x16	3/8	2.47	63	11/16	7/8	1.58	40	
10671-8-8	1/2	3/4x16	1/2	2.61	66	13/16	7/8	1.41	36	•
10671-10-8	5/8	7/8x14	1/2	2.84	72	7/8	1	1.64	42	
10671-10-10	5/8	7/8x14	5/8	2.83	72	15/16	1	1.58	40	
10671-10-12	5/8	7/8x14	3/4	2.92	74	1-1/16	1	1.54	39	
10671-12-8	3/4	1-1/16x12	1/2	2.75	70	1-1/16	1-1/4	1.58	40	
10671-12-10	3/4	1-1/16x12	5/8	3.00	76	1-1/16	1-1/4	1.75	44	
10671-12-12	3/4	1-1/16x12	3/4	2.96	75	1-1/16	1-1/4	1.60	41	•
10671-12-16	3/4	1-1/16x12	1	3.37	86	1-3/8	1-1/4	1.67	42	
10671-14-12	7/8	1-3/16x12	3/4	3.01	76	1-1/4	1-3/8	1.61	41	
10671-16-12	1	1-5/16x12	3/4	3.28	83	1-1/4	1-1/2	1.92	49	
10671-16-16	1	1-5/16x12	1	3.60	91	1-3/8	1-1/2	2.01	51	•
10671-20-16	1-1/4	1-5/8x12	1	3.80	97	1-5/8	2	2.21	56	
10671-20-20	1-1/4	1-5/8x12	1-1/4	3.92	100	1-7/8	2	2.25	57	
10671-24-20	1-1/2	1-7/8x12	1-1/4	4.10	104	2-1/8	2-1/4	2.43	62	
10671-24-24	1-1/2	1-7/8x12	1-1/2	4.69	119	2-1/8	2-1/4	2.50	64	•
10671-32-32	2	2-1/2x12	2	5.39	137	2-1/2	2-7/8	3.19	81	

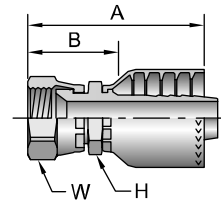

view on web page

**WARNING:** This product can expose you to chemicals including Lead, which is known to the State of California to cause cancer and birth defects or other reproductive harm. For more information go to [www.p65warnings.ca.gov](http://www.p65warnings.ca.gov).

# 13771

## Female JIC 37° - Swivel - 45° Elbow - Short Drop

# Part Number	Thread		Hose I.D. inch	A		E		W inch	B	
	inch	9/16x18		inch	mm	inch	mm		inch	mm
13771-6-6	3/8	9/16x18	3/8	2.34	59.0	0.43	11	11/16	1.44	37.0
13771-8-8	1/2	3/4x16	1/2	3.20	81.2	0.59	15	7/8	1.99	50.6
13771-10-8	5/8	7/8x14	1/2	2.93	74.0	0.63	16	1	1.72	44.0
13771-10-10	5/8	7/8x14	5/8	3.08	78.0	0.63	16	1	1.83	46.0
13771-12-12	3/4	1-1/16x12	3/4	3.64	92.0	0.83	21	1-1/4	2.26	57.0
13771-16-16	1	1-5/16x12	1	4.20	107.0	0.90	23	1-1/2	2.61	66.0
13771-20-20	1-1/4	1-5/8x12	1-1/4	5.22	133.0	1.69	43	2	3.53	90.0

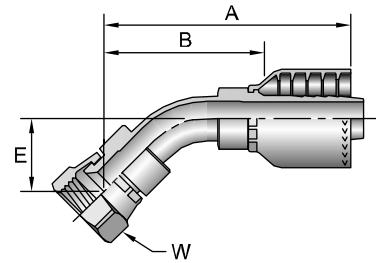

view on web page

**WARNING:** This product can expose you to chemicals including Lead, which is known to the State of California to cause cancer and birth defects or other reproductive harm. For more information go to [www.p65warnings.ca.gov](http://www.p65warnings.ca.gov).

Stainless steel fittings must be assembled with Karrykrimp 2, PHastkrimp, Superkrimp or Parkrimp 2. See CrimpSource for more information.

### 13971

#### Female JIC 37° - Swivel - 90° Elbow - Short Drop

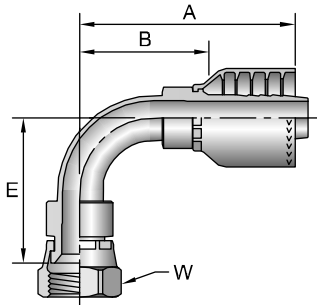

view on web page

# Part Number	Thread		Hose I.D. inch	A		E		W inch	B	
	inch	inch		inch	mm	inch	mm		inch	mm
13971-6-6	3/8	9/16x18	3/8	2.21	56	0.91	23	11/16	1.31	33
13971-8-8	1/2	3/4x16	1/2	2.62	67	1.14	29	7/8	1.41	36
13971-10-8	5/8	7/8x14	1/2	2.74	70	1.26	32	1	1.53	39
13971-10-10	5/8	7/8x14	5/8	2.88	73	1.26	32	1	1.63	41
13971-12-12	3/4	1-1/16x12	3/4	3.50	89	1.89	48	1-1/4	2.11	54
13971-16-16	1	1-5/16x12	1	4.36	111	2.20	56	1-1/2	2.58	66
13971-20-20	1-1/4	1-5/8x12	1-1/4	4.78	121	3.33	85	2	3.11	79
13971-24-24	1-1/2	1-7/8x12	1-1/2	6.33	161	3.98	101	2-1/4	4.14	105

**WARNING:** This product can expose you to chemicals including Lead, which is known to the State of California to cause cancer and birth defects or other reproductive harm. For more information go to [www.p65warnings.ca.gov](http://www.p65warnings.ca.gov).

### 1L971

#### Female JIC 37° - Swivel - 90° Elbow - Medium Drop

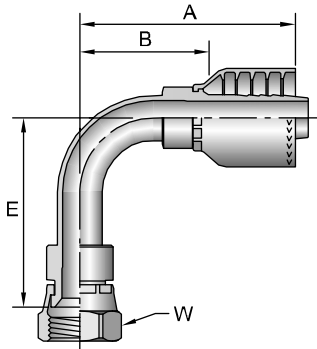

# Part Number	Thread		Hose I.D. inch	A		E		W inch	B	
	inch	inch		inch	mm	inch	mm		inch	mm
1L971-10-8	5/8	7/8x14	1/2	3.24	82	1.75	44	1	2.04	52

**WARNING:** This product can expose you to chemicals including Lead, which is known to the State of California to cause cancer and birth defects or other reproductive harm. For more information go to [www.p65warnings.ca.gov](http://www.p65warnings.ca.gov).

### 14171

#### Female JIC 37° - Swivel - 90° Elbow - Long Drop

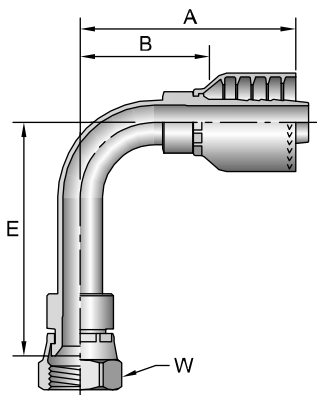

view on web page

# Part Number	Thread		Hose I.D. inch	A		E		W inch	B	
	inch	inch		inch	mm	inch	mm		inch	mm
14171-6-6	3/8	9/16x18	3/8	2.34	59	2.13	54	11/16	1.44	37
14171-8-8	1/2	3/4x16	1/2	2.58	66	2.52	64	7/8	1.37	35
14171-12-12	3/4	1-1/16x14	3/4	3.49	89	3.78	96	1-1/4	2.11	54
14171-16-16	1	1-5/16x12	1	4.36	111	4.32	110	1-1/2	2.58	66

**WARNING:** This product can expose you to chemicals including Lead, which is known to the State of California to cause cancer and birth defects or other reproductive harm. For more information go to [www.p65warnings.ca.gov](http://www.p65warnings.ca.gov).

# 11571

## SAE Code 61 Flange Head

ISO 12151-3 - S - L

# Part Number	Flange inch	Hose I.D. inch	A		F inch	B	
			inch	mm		inch	mm
11571-8-8	1/2	1/2	3.48	88	1-3/16	2.27	58
11571-10-10	5/8	5/8	3.69	93,7	1-11/32	2.44	62,0
11571-12-8	3/4	1/2	2.46	62,5	1-1/2	1.26	32,0
11571-12-12	3/4	3/4	3.86	98	1-1/2	2.48	63
11571-16-12	1	3/4	2.74	70	1-3/4	1.36	35
11571-16-16	1	1	4.32	110	1-3/4	2.55	65
11571-20-12	1-1/4	3/4	3.90	99	2	2.54	65
11571-20-16	1-1/4	1	3.27	83	2	1.58	40
11571-20-20	1-1/4	1-1/4	4.70	119	2	3.01	76
11571-20-24	1-1/4	1-1/2	5.41	137	2	3.22	82
11571-24-16	1-1/2	1	3.41	86,6	2-3/8	1.63	41,4
11571-24-20	1-1/2	1-1/4	3.48	104	2-3/8	1.36	61
11571-24-24	1-1/2	1-1/2	5.46	139	2-3/8	3.27	83
11571-32-24	2	1-1/2	4.01	102	2-13/16	1.82	46
11571-32-32	2	2	5.65	144	2-13/16	3.45	88
11571-40-32	2-1/2	2	4.51	115	3-5/16	2.31	59

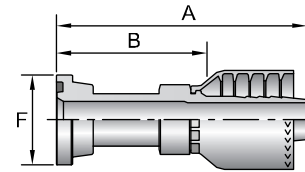

view on web page

**WARNING:** This product can expose you to chemicals including Lead, which is known to the State of California to cause cancer and birth defects or other reproductive harm. For more information go to [www.p65warnings.ca.gov](http://www.p65warnings.ca.gov).

# 11671

## SAE Code 61 Flange Head - 22-1/2° Elbow

ISO 12151-3 - E22M - L

# Part Number	Flange inch	Hose I.D. inch	A		E		F inch	B	
			inch	mm	inch	mm		inch	mm
11671-12-12	3/4	3/4	3.90	99	0.44	11	1-1/2	2.54	65
11671-16-12	1	3/4	3.89	99	0.44	11	1-3/4	2.53	64
11671-16-16	1	1	4.26	108	0.44	11	1-3/4	2.67	68
11671-20-20	1-1/4	1-1/4	4.67	119	0.50	13	2	3.00	76
11671-24-20	1-1/2	1-1/4	4.68	119	0.53	13	2-3/8	3.01	76
11671-24-24	1-1/2	1-1/2	5.88	149	0.63	16	2-3/8	3.69	94
11671-32-32	2	2	7.37	187	0.88	22	2-13/16	5.22	133

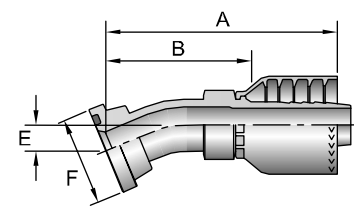

view on web page

**WARNING:** This product can expose you to chemicals including Lead, which is known to the State of California to cause cancer and birth defects or other reproductive harm. For more information go to [www.p65warnings.ca.gov](http://www.p65warnings.ca.gov).

See Accessories Section for O-Rings and Flange Kits.



## 12671

### SAE Code 61 Flange Head - 30° Elbow

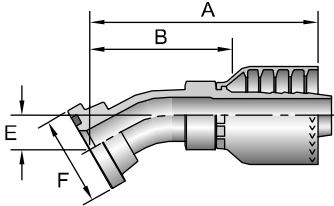
ISO 12151-3 - E30S - L (1 Piece: ISO 12151-3 - E30M - L)



view on web page

#			A		E			B	
Part Number	inch	inch	inch	mm	inch	mm	inch	inch	mm
12671-16-16	1	1	4.46	113	0.62	16	1-3/4	2.68	68
12671-24-24	1-1/2	1-1/2	6.01	153	0.88	22	2-3/8	3.82	97
12671-32-32	2	2	7.60	193	1.25	32	2-13/16	5.40	137

**WARNING:** This product can expose you to chemicals including Lead, which is known to the State of California to cause cancer and birth defects or other reproductive harm. For more information go to [www.p65warnings.ca.gov](http://www.p65warnings.ca.gov).



## 11771

### SAE Code 61 Flange Head - 45° Elbow

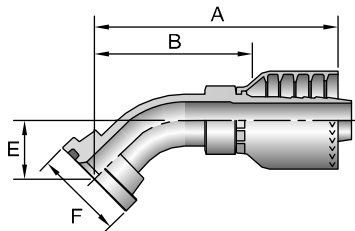
ISO 12151-3 - E45S - L (1 Piece: ISO 12151-3 - E45M - L)



view on web page

#			A		E			B	
Part Number	inch	inch	inch	mm	inch	mm	inch	inch	mm
11771-12-8	3/4	1/2	3.27	83	0.84	21	1-1/2	2.07	53
11771-12-12	3/4	3/4	3.85	98	1.02	26	1-1/2	2.47	63
11771-16-12	1	3/4	3.85	98	1.02	26	1-3/4	2.47	63
11771-16-16	1	1	4.84	123	1.26	32	1-3/4	3.06	78
11771-20-16	1-1/4	1	4.84	123	1.02	26	2	3.06	78
11771-20-20	1-1/4	1-1/4	5.61	142	1.50	38	2	3.92	100
11771-24-20	1-1/2	1-1/4	5.55	141	1.50	38	2-3/8	3.86	98
11771-24-24	1-1/2	1-1/2	6.22	158	1.41	36	2-3/8	4.03	102
11771-32-24	2	1-1/2	6.19	157	1.41	36	2-13/16	4.00	102
11771-32-32	2	2	7.94	202	2.03	52	2-13/16	5.74	146

**WARNING:** This product can expose you to chemicals including Lead, which is known to the State of California to cause cancer and birth defects or other reproductive harm. For more information go to [www.p65warnings.ca.gov](http://www.p65warnings.ca.gov).

See Accessories Section for O-Rings and Flange Kits.

# 12771

## SAE Code 61 Flange Head - 60° Elbow

ISO 12151-3 - E60S - L (1 Piece: ISO 12151-3 - E60M - L)

# Part Number	Flange inch	Hose I.D. inch	A		E		F inch	B	
			inch	mm	inch	mm		inch	mm
12771-12-12	3/4	3/4	4.16	106	1.43	36	1-1/2	2.78	71
12771-16-16	1	1	4.74	120	1.49	38	1-3/4	3.36	85
12771-20-20	1-1/4	1-1/4	5.10	130	1.69	43	2	3.41	87
12771-24-24	1-1/2	1-1/2	6.25	159	2.03	52	2-3/8	4.06	103
12771-32-32	2	2	7.93	201	2.88	73	2-13/16	5.73	146

**WARNING:** This product can expose you to chemicals including Lead, which is known to the State of California to cause cancer and birth defects or other reproductive harm. For more information go to [www.p65warnings.ca.gov](http://www.p65warnings.ca.gov).

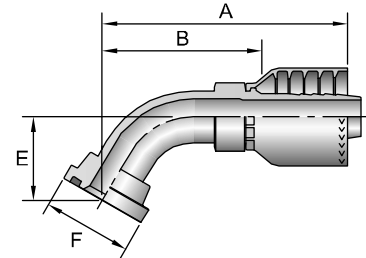

[view on web page](#)

# 11871

## SAE Code 61 Flange Head - 67-1/2° Elbow

ISO 12151-3 - E67S - L (1 Piece: ISO 12151-3 - E67M - L)

# Part Number	Flange inch	Hose I.D. inch	A		E		F inch	B	
			inch	mm	inch	mm		inch	mm
11871-12-12	3/4	3/4	4.12	105	1.62	41	1-1/2	2.74	70
11871-16-16	1	1	4.76	121	1.75	44	1-3/4	2.98	76
11871-24-20	1-1/2	1-1/4	5.07	129	1.95	50	2-3/8	3.38	86
11871-24-24	1-1/2	1-1/2	6.20	157	2.31	59	2-3/8	4.01	102
11871-32-32	2	2	7.89	200	3.31	84	2-13/16	5.69	145

**WARNING:** This product can expose you to chemicals including Lead, which is known to the State of California to cause cancer and birth defects or other reproductive harm. For more information go to [www.p65warnings.ca.gov](http://www.p65warnings.ca.gov).

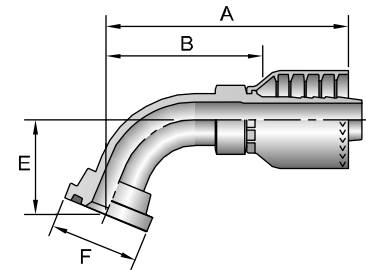

[view on web page](#)

# 11971

## SAE Code 61 Flange Head - 90° Elbow

ISO 12151-3 - E90S - L (1 Piece: ISO 12151-3 - E90M - L)

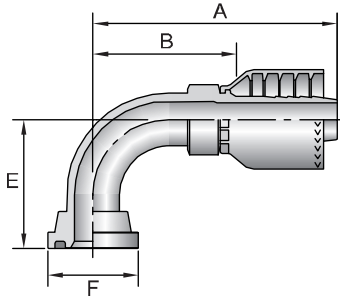

view on web page

# Part Number	Flange inch	Hose I.D. inch	A		E		F inch	B	
			inch	mm	inch	mm		inch	mm
11971-8-8	1/2	1/2	2.93	74	1.6	41	1-3/16	1.72	44
11971-12-8	3/4	1/2	2.93	74	1.66	42	1-1/2	1.72	44
11971-12-12	3/4	3/4	3.48	88	2.28	58	1-1/2	2.10	53
11971-16-12	1	3/4	3.52	89	2.28	58	1-3/4	2.14	54
11971-16-16	1	1	4.36	111	2.76	70	1-3/4	2.58	66
11971-16-20	1	1-1/4	4.53	115	2.39	61	1-3/4	2.75	70
11971-20-12	1-1/4	3/4	3.81	97	2.13	54	2	2.45	62
11971-20-16	1-1/4	1	4.33	110	2.76	70	2	2.55	65
11971-20-20	1-1/4	1-1/4	5.12	130	3.54	90	2	3.43	87
11971-20-24	1-1/4	1-1/2	6.33	161	3.00	76	2	4.14	105
11971-24-16	1-1/2	1	4.53	115	2.39	61	2-3/8	2.75	70
11971-24-20	1-1/2	1-1/4	5.09	129	3.54	90	2-3/8	3.40	86
11971-24-24	1-1/2	1-1/2	6.34	161	4.09	104	2-3/8	4.15	105
11971-32-24	2	1-1/2	6.98	148	4.09	79	2-13/16	4.36	93
11971-32-32	2	2	7.75	197	5.43	138	2-13/16	5.55	141

**WARNING:** This product can expose you to chemicals including Lead, which is known to the State of California to cause cancer and birth defects or other reproductive harm. For more information go to [www.p65warnings.ca.gov](http://www.p65warnings.ca.gov).

See Accessories Section for O-Rings and Flange Kits.

# 18971

## SAE Code 61 Flange Head - 90° Elbow - Long Drop

# Part Number	Flange inch	Hose I.D. inch	A		E		F inch	B	
			inch	mm	inch	mm		inch	mm
18971-12-12	3/4	3/4	3.49	89	3.03	77	1-1/2	2.11	54
18971-16-16	1	1	4.52	115	4.60	117	1-3/4	2.74	70
18971-20-16	1-1/4	1	4.53	115	4.60	117	2	2.75	70

**⚠ WARNING:** This product can expose you to chemicals including Lead, which is known to the State of California to cause cancer and birth defects or other reproductive harm. For more information go to [www.p65warnings.ca.gov](http://www.p65warnings.ca.gov).

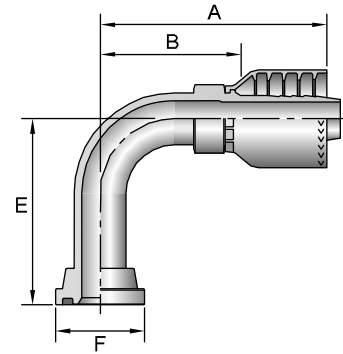

[view on web page](#)

# 16A71

## SAE Code 62 Flange Head ISO 12151-3 - S - S

# Part Number	Flange inch	Hose I.D. inch	A		F inch	B	
			inch	mm		inch	mm
16A71-12-12	3/4	3/4	4.31	109	1-5/8	2.93	74
16A71-16-12	1	3/4	3.10	78,7	1-7/8	1.72	43,7
16A71-16-16	1	1	4.89	124	1-7/8	3.11	79
16A71-20-16	1-1/4	1	3.69	93,7	2-1/8	1.91	48,5
16A71-20-20	1-1/4	1-1/4	5.01	127,3	2-1/8	3.32	84,3
16A71-24-24	1-1/2	1-1/2	6.34	161,0	2-1/2	4.15	105,4
16A71-32-32	2	2	7.16	182	3-1/8	4.96	126

**⚠ WARNING:** This product can expose you to chemicals including Lead, which is known to the State of California to cause cancer and birth defects or other reproductive harm. For more information go to [www.p65warnings.ca.gov](http://www.p65warnings.ca.gov).

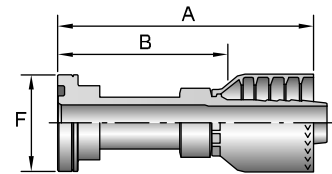

[view on web page](#)

See Accessories Section for O-Rings and Flange Kits.



# 16F71

## SAE Code 62 Flange Head - 45° Elbow

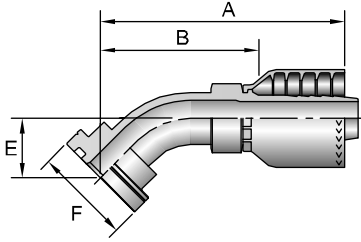
ISO 12151-3 - E45S - L (1 Piece: ISO 12151-3 - E45M - S)



view on web page

#			A		E			B	
Part Number	Flange inch	Hose I.D. inch	inch	mm	inch	mm	inch	inch	mm
16F71-12-12	3/4	3/4	3.82	97	1.03	26	1-5/8	2.44	62
16F71-16-16	1	1	4.74	120,3	1.26	32	1-7/8	2.96	75,2
16F71-20-16	1-1/4	1	4.61	117	1.06	27	2-1/8	3.02	77
16F71-20-20	1-1/4	1-1/4	5.07	129	1.19	30	2-1/8	3.38	86
16F71-24-24	1-1/2	1-1/2	6.21	158	1.44	37	2-1/2	4.02	102

**WARNING:** This product can expose you to chemicals including Lead, which is known to the State of California to cause cancer and birth defects or other reproductive harm. For more information go to [www.p65warnings.ca.gov](http://www.p65warnings.ca.gov).



# 16N71

## SAE Code 62 Flange Head - 90° Elbow

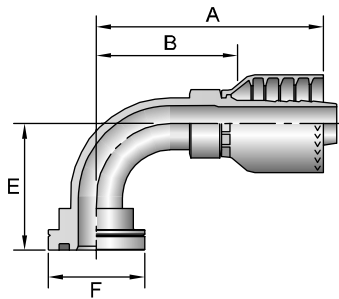
ISO 12151-3 - E90S - L (1 Piece: ISO 12151-3 - E90M - S)



view on web page

#			A		E			B	
Part Number	Flange inch	Hose I.D. inch	inch	mm	inch	mm	inch	inch	mm
16N71-12-12	3/4	3/4	3.51	89	2.28	58	1-5/8	2.13	54
16N71-16-12	1	3/4	3.49	89	2.29	58	1-7/8	2.11	54
16N71-16-16	1	1	4.36	111	2.76	70	1-7/8	2.58	66
16N71-20-16	1-1/4	1	4.36	111	2.76	70	2-1/8	2.58	66
16N71-20-20	1-1/4	1-1/4	5.09	129	3.54	90	2-1/8	3.40	86
16N71-24-24	1-1/2	1-1/2	6.73	171	4.09	104	2-1/2	4.54	115
16N71-32-32	2	2	7.73	196	4.50	114	3-1/8	5.53	140

**WARNING:** This product can expose you to chemicals including Lead, which is known to the State of California to cause cancer and birth defects or other reproductive harm. For more information go to [www.p65warnings.ca.gov](http://www.p65warnings.ca.gov).



# 1J071

## Male Seal-Lok® - Rigid - (with O-Ring)

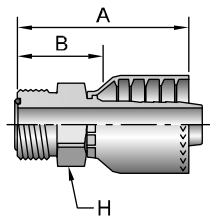
SAE J516 (Apr2016)

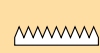

view on web page

#			A			B		
Part Number	Thread inch	Hose I.D. inch	inch	mm	inch	inch	mm	
1J071-8-8	1/2	13/16x16	1/2	2.40	61	7/8	1.20	30
1J071-10-8	5/8	1x14	1/2	2.61	66	1-1/16	1.41	36
1J071-10-10	5/8	1x14	5/8	2.69	68	1-1/16	1.44	37
1J071-12-10	3/4	1-3/16x12	5/8	2.79	71	1-1/4	1.55	39
1J071-12-12	3/4	1-3/16x12	3/4	2.87	73	1-1/4	1.51	38
1J071-16-12	1	1-7/16x12	3/4	2.91	74	1-1/2	1.53	39
1J071-16-16	1	1-7/16x12	1	3.27	83	1-1/2	1.68	43
1J071-20-20	1-1/4	1-11/16x12	1-1/4	3.31	84	1-3/4	1.64	42

**WARNING:** This product can expose you to chemicals including Lead, which is known to the State of California to cause cancer and birth defects or other reproductive harm. For more information go to [www.p65warnings.ca.gov](http://www.p65warnings.ca.gov).

See Accessories Section for O-Rings.

**Refer to Pressure Rating of Hose End Connections Chart on page E-47.**



# 1JC71

## Female Seal-Lok® - Swivel - Short ISO 12151-1 - SWSA

# Part Number	Thread		Hose I.D. inch	A		C		H		W		B	
	inch	inch		inch	mm	inch	mm	inch	inch	inch	mm	inch	mm
1JC71-8-8	1/2	13/16x16	1/2	2.22	56	0.43	11	13/16	15/16	1.01	26		
1JC71-10-10	5/8	1x14	5/8	2.40	61	0.48	12	15/16	1-1/8	1.15	29		
1JC71-12-12	3/4	1-3/16x12	3/4	2.68	68	0.55	14	1-1/8	1-3/8	1.30	33		
1JC71-16-16	1	1-7/16x12	1	3.22	82	0.56	14	1-3/8	1-5/8	1.44	37		
1JC71-20-16	1-1/4	1-11/16x12	1	3.16	80	0.59	15	1-5/8	1-7/8	1.38	35		

When measuring overall length to end of nut, B+C dimensions must be used to calculate cut-off allowance.

See Accessories Section for O-Rings and Flange Kits.

**WARNING:** This product can expose you to chemicals including Lead, which is known to the State of California to cause cancer and birth defects or other reproductive harm. For more information go to [www.p65warnings.ca.gov](http://www.p65warnings.ca.gov).

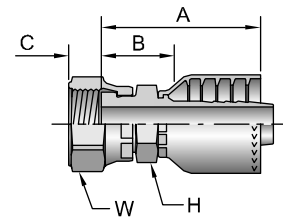

view on web page

# 1JS71

## Female Seal-Lok® - Swivel - Long ISO 12151-1 - SWSB

# Part Number	Thread		Hose I.D. inch	A		H		W		B	
	inch	inch		inch	mm	inch	inch	inch	mm	inch	mm
1JS71-6-6	3/8	11/16x16	3/8	2.80	58	11/16	13/16	1.38	35		
1JS71-6-8	3/8	11/16x16	1/2	2.50	64	13/16	13/16	1.29	33		
1JS71-8-8	1/2	13/16x16	1/2	2.64	67	13/16	15/16	1.44	37		
1JS71-10-8	5/8	1x14	1/2	2.89	23	13/16	1-1/8	1.69	43		
1JS71-10-10	5/8	1x14	5/8	3.00	76	15/16	1-1/8	1.75	44		
1JS71-10-12	5/8	1x14	3/4	3.08	78	1-1/16	1-1/8	1.70	43		
1JS71-12-10	3/4	1-3/16x12	5/8	3.10	79	1-1/8	1-3/8	1.85	47		
1JS71-12-12	3/4	1-3/16x12	3/4	3.31	84	1-1/16	1-3/8	1.93	49		
1JS71-16-12	1	1-7/16x12	3/4	3.37	86	1-5/16	1-5/8	1.99	51		
1JS71-16-16	1	1-7/16x12	1	3.70	94	1-5/16	1-5/8	1.92	49		
1JS71-20-16	1-1/4	1-11/16x12	1	3.64	92	1-3/4	1-7/8	1.94	49		
1JS71-20-20	1-1/4	1-11/16x12	1-1/4	3.77	96	1-3/4	1-7/8	2.08	53		
1JS71-24-24	1-1/2	2x12	1-1/2	4.51	114,6	2	2-1/4	2.32	58,9		

**WARNING:** This product can expose you to chemicals including Lead, which is known to the State of California to cause cancer and birth defects or other reproductive harm. For more information go to [www.p65warnings.ca.gov](http://www.p65warnings.ca.gov).

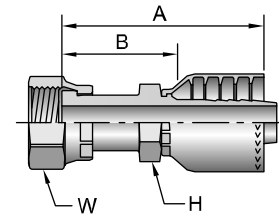

view on web page

See Accessories Section for O-Rings.

**Refer to Pressure Rating of Hose End Connections Chart on page E-47.**

# 1J771

## Female Seal-Lok® - Swivel - 45° Elbow

ISO 12151-1 - SWE45

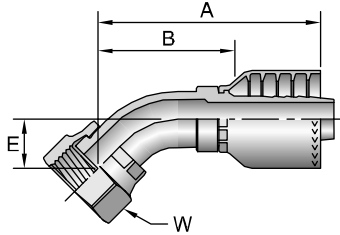

view on web page

# Part Number	Thread		Hose I.D. inch	A		E		W		B	
	inch	mm		inch	mm	inch	mm	inch	mm		
1J771-6-6	3/8	11/16x16	3/8	2.34	59.0	0.43	11	13/16	1.44	37.0	
1J771-8-8	1/2	13/16x16	1/2	3.20	81.2	0.59	15	15/16	1.99	50.6	
1J771-10-8	5/8	1x14	1/2	2.93	74.0	0.63	16	1-1/8	1.72	44.0	
1J771-10-10	5/8	1x14	5/8	3.08	78.0	0.63	16	1-1/8	1.83	46.0	
1J771-12-12	3/4	1-3/16x12	3/4	3.63	92.0	0.83	21	1-3/8	2.25	57.0	
1J771-16-16	1	1-7/16x12	1	4.46	113.0	0.94	24	1-5/8	2.68	68.0	
1J771-20-20	1-1/4	1-11/16x12	1-1/4	4.75	121.0	1.00	25	1-7/8	3.08	78.0	
1J771-24-24	1-1/2	2x12	1-1/2	5.43	138.0	1.07	27	2-1/4	3.23	82.0	

**WARNING:** This product can expose you to chemicals including Lead, which is known to the State of California to cause cancer and birth defects or other reproductive harm. For more information go to [www.p65warnings.ca.gov](http://www.p65warnings.ca.gov).

# 1J971

## Female Seal-Lok® - Swivel - 90° Elbow - Short Drop

ISO 12151-1 - SWES90

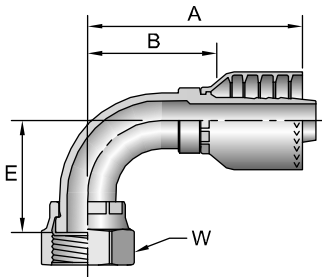

view on web page

# Part Number	Thread		Hose I.D. inch	A		E		W		B	
	inch	mm		inch	mm	inch	mm	inch	mm		
1J971-6-6	3/8	11/16x16	3/8	2.21	56	0.91	23	13/16	1.31	33	
1J971-8-8	1/2	13/16x16	1/2	2.59	66	1.14	29	15/16	1.38	35	
1J971-10-8	5/8	1x14	1/2	2.74	70	1.26	32	1-1/8	1.53	39	
1J971-10-10	5/8	1x14	5/8	2.88	73	1.26	32	1-1/8	1.63	41	
1J971-10-12	5/8	1x14	3/4	3.07	78	1.27	32	1-1/8	1.70	43	
1J971-12-10	3/4	1-3/16x12	5/8	3.40	86	1.89	48	1-3/8	2.15	55	
1J971-12-12	3/4	1-3/16x12	3/4	3.49	89	1.89	48	1-3/8	2.11	54	
1J971-16-16	1	1-7/16x12	1	4.36	111	2.20	56	1-5/8	2.58	66	
1J971-20-20	1-1/4	1-11/16x12	1-1/4	4.86	123	2.51	64	1-7/8	3.19	81	
1J971-24-24	1-1/2	2x12	1-1/2	6.22	158	2.68	68	2-1/4	4.03	102	

**WARNING:** This product can expose you to chemicals including Lead, which is known to the State of California to cause cancer and birth defects or other reproductive harm. For more information go to [www.p65warnings.ca.gov](http://www.p65warnings.ca.gov).

See Accessories Section for O-Rings.

# 1J571

## Female Seal-Lok® - Swivel - 90° Elbow - Medium Drop ISO 12151-1 - SWEM90

# Part Number	Thread		Hose I.D. inch	A		E		W inch	B	
	inch	13/16x16		inch	mm	inch	mm		inch	mm
1J571-8-8	1/2	13/16x16	1/2	2.59	66	1.61	41	15/16	1.38	35
1J571-10-10	5/8	1x14	5/8	2.88	73	1.85	47	1-1/8	1.63	41
1J571-12-12	3/4	1-3/16x12	3/4	3.49	89	2.28	58	1-3/8	2.11	54

**WARNING:** This product can expose you to chemicals including Lead, which is known to the State of California to cause cancer and birth defects or other reproductive harm. For more information go to [www.p65warnings.ca.gov](http://www.p65warnings.ca.gov).

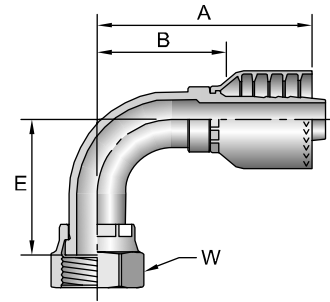

view on web page

# 1J171

## Female Seal-Lok® - Swivel - 90° Elbow - Long Drop ISO 12151-1 - SWEL90

# Part Number	Thread		Hose I.D. inch	A		E		W inch	B	
	inch	11/16x16		inch	mm	inch	mm		inch	mm
1J171-6-6	3/8	11/16x16	3/8	2.39	61	2.13	54	13/16	1.49	38
1J171-8-8	1/2	13/16x16	1/2	2.59	66	2.52	64	15/16	1.38	35
1J171-10-10	5/8	1x14	5/8	2.88	73	2.76	70	1-1/8	1.63	41
1J171-12-12	3/4	1-3/16x12	3/4	3.49	89	3.78	96	1-3/8	2.11	54
1J171-16-12	1	1-7/16x12	3/4	4.07	103	4.50	114	1-5/8	2.69	68
1J171-16-16	1	1-7/16x12	1	4.36	111	4.49	114	1-5/8	2.58	66

**WARNING:** This product can expose you to chemicals including Lead, which is known to the State of California to cause cancer and birth defects or other reproductive harm. For more information go to [www.p65warnings.ca.gov](http://www.p65warnings.ca.gov).

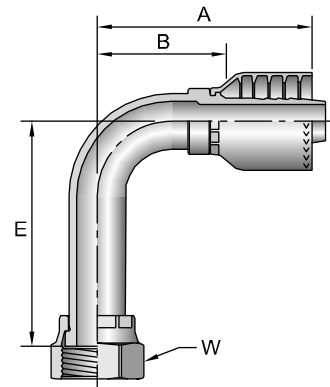

view on web page

Metric S: Mates with EO "S" Series Fittings.

^^ Must be assembled with Die Part No. 83C-D20H in a Superkrimp or Parkrimp 2. See Accessories Section for O-Rings and Flange Kits.

### 1C971

#### Female Metric S - Swivel - (24° Cone with O-Ring)

ISO 12151-2 - SWS - S

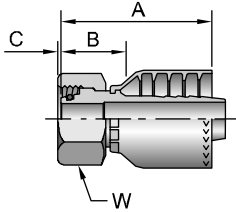

view on web page

# Part Number	Thread mm	Hose I.D. inch	A		C		W		B	
			inch	mm	inch	mm	mm	inch	mm	
1C971-16-8	16 M24x1,5	1/2	2.33	59	0.09	2	30	0.94	24	
1C971-30-16	30 M42x2	1	3.07	78	0.19	5	50	1.30	33	

When measuring overall length to end of nut, B+C dimensions must be used to calculate cut-off allowance.

**WARNING:** This product can expose you to chemicals including Lead, which is known to the State of California to cause cancer and birth defects or other reproductive harm. For more information go to [www.p65warnings.ca.gov](http://www.p65warnings.ca.gov).

### 1GU71

#### Female BSP Parallel Pipe - Swivel - (60° Cone)

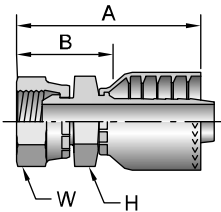

view on web page

# Part Number	Thread inch		Hose I.D. inch	A		H	W	B	
	inch	mm		inch	mm	mm	mm	inch	mm
1GU71-8-8	1/2	1/2x14	1/2	2.81	71	27	27	1.61	41
1GU71-12-12	3/4	3/4x14	3/4	3.24	82	36	36	1.86	47
1GU71-16-16	1	1x11	1	3.82	97	41	41	2.04	52
1GU71-20-20	1-1/4	1-1/4x11	1-1/4	4.07	103	50	50	2.38	60
1GU71-32-32	2	2x11	2	5.17	131	70	70	2.97	75

**WARNING:** This product can expose you to chemicals including Lead, which is known to the State of California to cause cancer and birth defects or other reproductive harm. For more information go to [www.p65warnings.ca.gov](http://www.p65warnings.ca.gov).

Metric S: Mates with EO "S" Series Fittings.

^ Must be assembled with Die Part No. 83C-D20H in a Superkrimp or Parkrimp 2.

See Accessories Section for O-Rings and Flange Kits.

## 1FU71 Female BSP Parallel Pipe - Swivel - (30° Flare)

# Part Number	Thread inch	Hose I.D. inch	A		H mm	W mm	B	
			inch	mm			inch	mm
1FU71-12-12	3/4x14	3/4	3.10	79	36	36	1.74	44
1FU71-16-16	1x11	1	3.52	89	41	41	1.95	49
1FU71-20-20	1-1/4x11	1-1/4	3.87	98	50	50	2.20	56

**WARNING:** This product can expose you to chemicals including Lead, which is known to the State of California to cause cancer and birth defects or other reproductive harm. For more information go to [www.p65warnings.ca.gov](http://www.p65warnings.ca.gov).

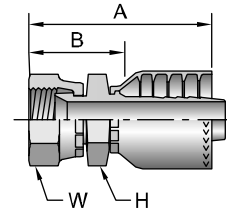

[view on web page](#)

## 1MU71 Female Metric - Swivel - (30° Flare)

# Part Number	Thread mm	Hose I.D. inch	A		H mm	W mm	B	
			inch	mm			inch	mm
1MU71-6-6	M18x1,5	3/8	2.45	62	24	24	1.56	40
1MU71-8-8	M22x1,5	1/2	2.83	72	27	27	1.45	37

Japanese Fittings - Female Swivel 30° Flare with Metric Threads. All 30° flared fitting sizes are available by combining 1MU71 fittings in sizes up to 1/2 with 1XU71 fittings in sizes 5/8 inch and larger.

**WARNING:** This product can expose you to chemicals including Lead, which is known to the State of California to cause cancer and birth defects or other reproductive harm. For more information go to [www.p65warnings.ca.gov](http://www.p65warnings.ca.gov).

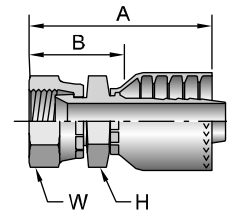

[view on web page](#)

## 1XU71 Female Metric - Swivel - (30° Flare)







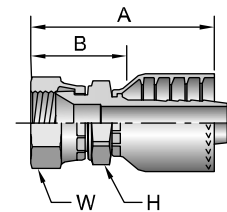



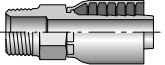

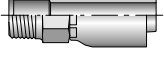
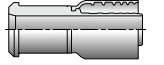
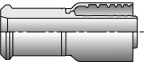

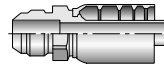
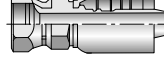
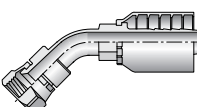
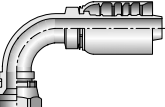
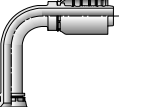
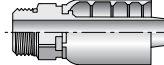

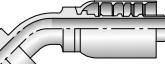
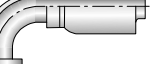

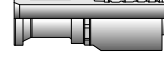
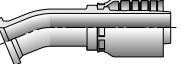
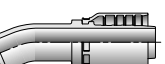
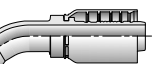
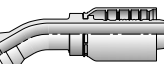
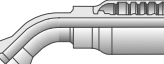
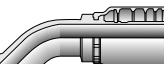

# Part Number	Thread mm	Hose I.D. inch	A		H mm	W mm	B	
			inch	mm			inch	mm
1XU71-10-10	M24x1,5	5/8	3.16	80	30	32	1.91	49
1XU71-12-12	M30x1,5	3/4	3.40	86	32	36	2.02	51
1XU71-16-16	M33x1,5	1	4.11	104	36	41	2.33	59



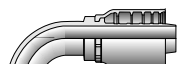
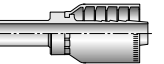



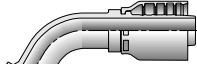
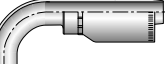
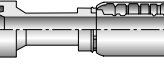



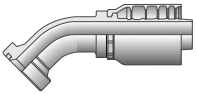
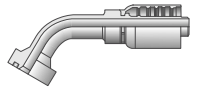
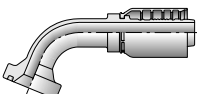
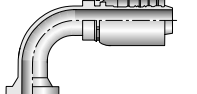

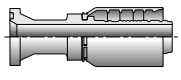
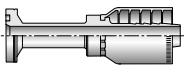
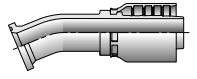
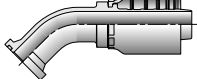

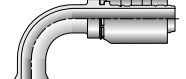

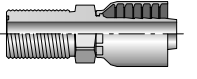
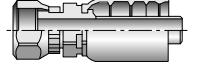
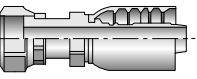
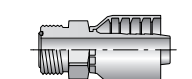
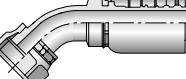
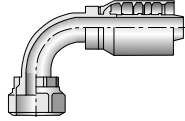
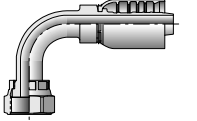
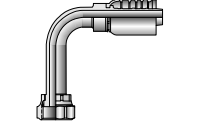
Japanese Fittings - Female Swivel 30° Flare with Metric Threads. All 30° flared fitting sizes are available by combining 1MU71 fittings in sizes up to 1/2 with 1XU71 fittings in sizes 5/8 inch and larger.

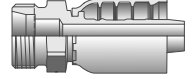
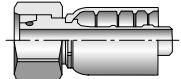
**WARNING:** This product can expose you to chemicals including Lead, which is known to the State of California to cause cancer and birth defects or other reproductive harm. For more information go to [www.p65warnings.ca.gov](http://www.p65warnings.ca.gov).

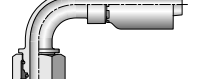

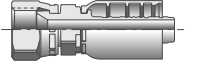
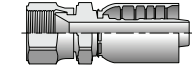
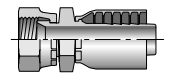
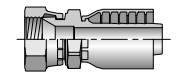
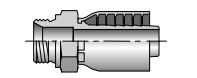
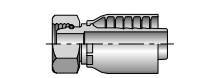
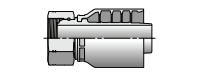
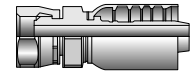
[view on web page](#)

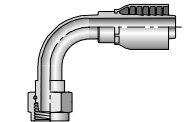
A	NPTF Pipe		10177 B-92  Male - Rigid - Straight	10277 B-92  Female - Rigid Straight	API	1AP77 B-92  Male - Rigid - Straight	Hammer Union
	1HB77 B-93  Male - Hammer Union 90° Wing Nut	1HE77 B-93  Male - Hammer Union	1HN77 B-93  Female - Hammer Union	JIC 37°	10377 B-93  Male - Rigid - Straight	10677 B-94  Female - Swivel Straight	
B	13777 B-95  Female - Swivel 45° Elbow - Short	13977 B-95  Female - Swivel 90° Elbow - Short	14177 B-96  Female - Swivel 90° Elbow - Long	Straight Thread O-Ring	10577 B-96  Male - Rigid - Straight	Full Flange	
	1X577 B-96  Full Flange - Straight	1X777 B-97  Full Flange 45° Elbow	1X977 B-97  Full Flange 90° Elbow	Flange Code 61	11577 B-98  Code 61 - Straight	14A77 B-98  Straight (5,000 psi)	
C	11677 B-99  Code 61 22-1/2° Elbow	14B77 B-99  22-1/2° Elbow (5,000 psi)	12677 B-99  Code 61 - 30° Elbow	14E77 B-100  30° Elbow (5,000 psi)	11777 B-100  Code 61 - 45° Elbow	14F77 B-101  45° Elbow (5,000 psi)	
	12777 B-101  Code 61 - 60° Elbow	14G77 B-102  60° Elbow (5,000 psi)	11877 B-102  Code 61 67-1/2° Elbow	14M77 B-103  67-1/2° Elbow (5,000 psi)	11977 B-103  Code 61 - 90° Elbow	18977 B-104  Code 61 90° Elbow - Long	
D	14N77 B-104  90° Elbow (5,000 psi)	Flange Code 62	16A77 B-105  Code 62 - Straight	16B77 B-105  Code 62 22-1/2° Elbow	16E77 B-106  Code 62 - 30° Elbow	16F77 B-106  Code 62 - 45° Elbow	
	16G77 B-107  Code 62 - 60° Elbow	16N77 B-107  Code 62 - 90° Elbow	Caterpillar® Flange	1XA77 B-108  Caterpillar® - Flange	1XB77 B-108  Caterpillar® - Flange 22-1/2° Elbow	1XE77 B-109  Caterpillar® Flange 30° Elbow	
E							

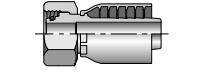
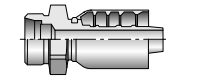
<p>1XF77 B-109</p>  <p>Caterpillar® - Flange 45° Elbow</p>	<p>1XG77 B-110</p>  <p>Caterpillar® - Flange 60° Elbow</p>	<p>1XM77 B-110</p>  <p>Caterpillar® Flange 67-1/2° Elbow</p>	<p>1XN77 B-111</p>  <p>Caterpillar® Flange 90° Elbow</p>	 <p>Komatsu® Flange</p>	<p>1K577 B-111</p>  <p>Komatsu® Flange Straight</p>
<p>1KA77 B-111</p>  <p>Komatsu® HP Flange Straight</p>	<p>1K677 B-112</p>  <p>Komatsu® Flange 22-1/2° Elbow</p>	<p>1K777 B-112</p>  <p>Komatsu® Flange 45° Elbow</p>	<p>1K377 B-112</p>  <p>Komatsu® Flange 60° Elbow</p>	<p>1K877 B-113</p>  <p>Komatsu® Flange 67-1/2° Elbow</p>	<p>1K977 B-113</p>  <p>Komatsu® Flange 90° Elbow</p>
 <p>Seal-Lok®</p>	<p>1JB77 B-113</p>  <p>Male - Bulkhead w/o Locknut</p>	<p>1JC77 B-114</p>  <p>Female - Swivel Straight - Short</p>	<p>1JS77 B-114</p>  <p>Female - Swivel Straight - Long</p>	<p>1J077 B-115</p>  <p>Male - Rigid w/O-Ring</p>	<p>1J777 B-115</p>  <p>Female - Swivel 45° Elbow</p>
<p>1J977 B-116</p>  <p>Female - Swivel 90° Elbow - Short</p>	<p>1J577 B-116</p>  <p>Female - Swivel 90° Elbow - Medium</p>	<p>1J177 B-117</p>  <p>Female - Swivel 90° Elbow - Long</p>	 <p>DIN "S" Series w/O-Ring</p>	<p>1D277 B-117</p>  <p>Male Metric S Rigid - 24° Cone</p>	<p>1C977 B-118</p>  <p>Female - Swivel Straight</p>
<p>10C77 B-118</p>  <p>Female Metric S Swivel - 45° Elbow</p>	<p>11C77 B-119</p>  <p>Female - Swivel 90° Elbow</p>	 <p>BSP</p>	<p>1FU77 B-119</p>  <p>Female - Swivel Straight - 30° Flare</p>	<p>1KU77 B-120</p>  <p>Female - Metric Swivel - 30° Flare</p>	<p>1MU77 B-120</p>  <p>Female - Metric Swivel - 30° Flare</p>
<p>1XU77 B-120</p>  <p>Female - Swivel 30° Flare</p>	<p>1D977 B-121</p>  <p>Male - Rigid Straight - 60° Cone</p>	<p>19277 B-121</p>  <p>Female - Swivel Straight - 60° Cone</p>	<p>1EA77 B-121</p>  <p>Female - Swivel Straight - 60° Cone</p>	<p>1GU77 B-122</p>  <p>Female - Swivel Straight - 60° Cone</p>	<p>1B177 B-122</p>  <p>Female - Swivel 45° Elbow - 60° Cone</p>
<p>1B277 B-123</p>  <p>Female - Swivel 90° Elbow - 60° Cone</p>	 <p>24° Cone</p>	<p>1CA77 B-123</p>  <p>Female - Swivel Straight - 24° Cone</p>	<p>1ZM77 B-123</p>  <p>Male 24° Cone Rigid - Straight</p>		

A

B

C

D

E

## 10177 Male NPTF Pipe - Rigid

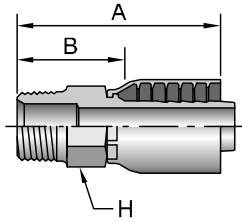

view on web page

# Part Number	Thread inch	Hose I.D. inch	A		H	B		Additional Material Stainless Steel (C)
			inch	mm	mm	inch	mm	
10177-6-8	3/8x18	1/2	2.51	63,9	22	1.29	32,9	
10177-8-8	1/2x14	1/2	2.72	69,2	22	1.50	38,2	●
10177-8-12	1/2x14	3/4	3.43	87,1	30	1.79	45,5	
10177-12-12	3/4x14	3/4	3.43	87,1	30	1.79	45,5	●
10177-16-16	1x11-1/2	1	4.04	102,6	36	2.09	53,1	●
10177-20-16	1-1/4x11-1/2	1	4.34	110,2	46	2.39	60,7	
10177-20-20	1-1/4x11-1/2	1-1/4	4.57	116,1	46	2.30	58,4	●
10177-24-20	1-1/2x11-1/2	1-1/4	4.76	120,9	50	2.49	63,2	
10177-24-24	1-1/2x11-1/2	1-1/2	4.89	124,2	50	2.50	63,5	●
10177-32-32*	2x11-1/2	2	5.64	143,1	65	2.88	73,2	●

\*This specific size in stainless is not able to be crimped in any Parkrimp machine.

**WARNING:** This product can expose you to chemicals including Lead, which is known to the State of California to cause cancer and birth defects or other reproductive harm. For more information go to [www.p65warnings.ca.gov](http://www.p65warnings.ca.gov).

## 10277 Female NPTF Pipe - Rigid

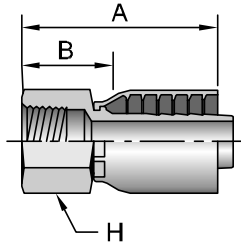

view on web page

# Part Number	Thread inch	Hose I.D. inch	A		H	B	
			inch	mm	mm	inch	mm
10277-12-12	3/4x14	3/4	3.09	78,4	32	1.45	36,9

**WARNING:** This product can expose you to chemicals including Lead, which is known to the State of California to cause cancer and birth defects or other reproductive harm. For more information go to [www.p65warnings.ca.gov](http://www.p65warnings.ca.gov).

## 1AP77 Male API Pipe - Rigid

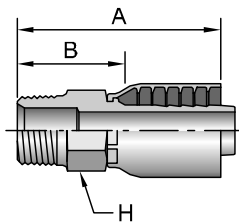

view on web page

# Part Number	Thread inch	Hose I.D. inch	A		H	B	
			inch	mm	mm	inch	mm
1AP77-24-24	1-1/2x11-1/2	1-1/2	5.16	131,1	50	2.77	70,4
1AP77-32-24	2x11-1/2	1-1/2	5.71	145,0	65	3.32	84,4
1AP77-32-32	2x11-1/2	2	6.32	160,4	65	3.56	90,4

**WARNING:** This product can expose you to chemicals including Lead, which is known to the State of California to cause cancer and birth defects or other reproductive harm. For more information go to [www.p65warnings.ca.gov](http://www.p65warnings.ca.gov).

See Accessories Section for O-Rings and Flange Kits.

**Refer to Pressure Rating of Hose End Connections Chart on page E-47.**



### 1HB77

#### Male Hammer Union - 90° Wing Nut

FIG 1502

# Part Number	Hose I.D. inch	A		B	
		inch	mm	inch	mm
1HB77-32-32	2	7.59	192,9	4.84	123,0

**WARNING:** This product can expose you to chemicals including Lead, which is known to the State of California to cause cancer and birth defects or other reproductive harm. For more information go to [www.p65warnings.ca.gov](http://www.p65warnings.ca.gov).

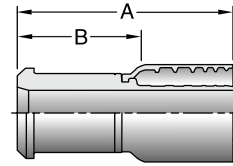

[view on web page](#)

### 1HE77

#### Male Hammer Union

FIG 1502

# Part Number	Hose I.D. inch	A		B	
		inch	mm	inch	mm
1HE77-32-32	2	7.60	192,9	4.84	123,0

**WARNING:** This product can expose you to chemicals including Lead, which is known to the State of California to cause cancer and birth defects or other reproductive harm. For more information go to [www.p65warnings.ca.gov](http://www.p65warnings.ca.gov).

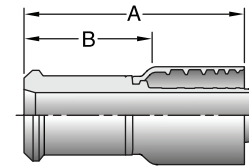

[view on web page](#)

### 1HN77

#### Female Hammer Union

FIG 1502

# Part Number	Thread inch	Hose I.D. inch	A		B	
			inch	mm	inch	mm
1HN77-32-32	4-1/8x3	2	6.95	176,4	4.19	106,5

**WARNING:** This product can expose you to chemicals including Lead, which is known to the State of California to cause cancer and birth defects or other reproductive harm. For more information go to [www.p65warnings.ca.gov](http://www.p65warnings.ca.gov).

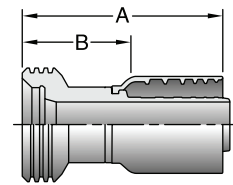

[view on web page](#)

### 10377

#### Male JIC 37° - Rigid

# Part Number	Thread inch	Hose I.D. inch	A		H mm	B	
			inch	mm		inch	mm
10377-8-8	1/2 3/4x16	1/2	2.61	66,4	22	1.39	35,4
10377-10-8	5/8 7/8x14	1/2	2.71	68,9	24	1.49	37,9
10377-10-10	5/8 7/8x14	5/8	3.01	76,4	24	1.66	42,2
10377-12-10	3/4 1-1/16x12	5/8	3.22	81,8	30	1.87	47,5
10377-12-12	3/4 1-1/16x12	3/4	3.53	89,6	30	1.89	48,1
10377-12-16	3/4 1-1/16x12	1	3.94	100,0	36	1.99	50,6
10377-16-12	1 1-5/16x12	3/4	3.69	93,6	36	2.05	52,2
10377-16-16	1 1-5/16x12	1	3.99	101,3	36	2.04	51,8
10377-20-16	1-1/4 1-5/8x12	1	4.33	109,9	50	2.38	60,5
10377-20-20	1-1/4 1-5/8x12	1-1/4	4.66	118,4	50	2.39	60,7
10377-24-24	1-1/2 1-7/8x12	1-1/2	4.93	125,2	50	2.54	64,5
10377-32-32	2 2-1/2x12	2	5.83	148,0	65	3.07	78,0

**WARNING:** This product can expose you to chemicals including Lead, which is known to the State of California to cause cancer and birth defects or other reproductive harm. For more information go to [www.p65warnings.ca.gov](http://www.p65warnings.ca.gov).

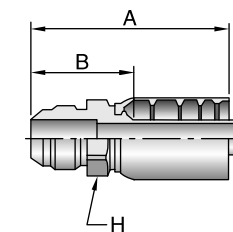

[view on web page](#)

See Accessories Section for O-Rings and Flange Kits.

**Refer to Pressure Rating of Hose End Connections Chart on page E-47.**

# 10677

## Female JIC 37° - Swivel

### ISO 12151-5

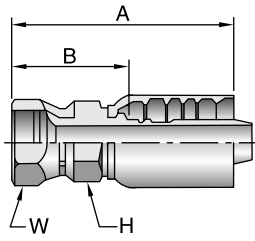

view on web page

# Part Number	Thread		Hose I.D. inch	A		Hexagonal Base		B	
	inch	mm		inch	mm	H mm	W mm	inch	mm
10677-6-8	3/8	9/16x18	1/2	2.75	69,7	22	19	1.53	38,8
10677-6-8C	3/8	9/16x18	1/2	2.75	69,7	22	19	1.53	38,8
10677-8-8	1/2	3/4x16	1/2	2.79	71,1	22	22	1.58	40,1
10677-8-8C	1/2	3/4x16	1/2	2.79	71,1	22	22	1.58	40,1
10677-10-8	5/8	7/8x14	1/2	2.91	74,0	22	27	1.69	43,0
10677-10-10	5/8	7/8x14	5/8	3.18	80,7	24	27	1.83	46,5
10677-10-10C	5/8	7/8x14	5/8	3.18	80,7	24	27	1.83	46,5
10677-10-12	5/8	7/8x14	3/4	3.62	91,8	30	27	1.98	50,3
10677-12-8	3/4	1-1/16x12	1/2	3.17	80,4	30	32	1.95	49,5
10677-12-10	3/4	1-1/16x12	5/8	3.30	83,9	30	32	1.95	49,6
10677-12-12	3/4	1-1/16x12	3/4	3.66	93,5	30	32	2.03	52,0
10677-12-12C	3/4	1-1/16x12	3/4	3.77	95,7	30	36	2.13	54,2
10677-12-16	3/4	1-1/16x12	1	4.12	104,7	36	32	2.17	55,2
10677-14-12	7/8	1-3/16x12	3/4	3.88	98,5	36	36	2.24	56,9
10677-16-12	1	1-5/16x12	3/4	3.87	98,7	30	41	2.24	57,3
10677-16-12C	1	1-5/16x12	3/4	4.01	101,8	36	46	2.37	60,3
10677-16-16	1	1-5/16x12	1	4.15	105,7	36	41	2.20	56,2
10677-16-16C	1	1-5/16x12	1	4.16	105,7	36	41	2.21	56,2
10677-16-20	1	1-5/16x12	1-1/4	4.84	123,0	46	41	2.57	65,3
10677-20-16	1-1/4	1-5/8x12	1	4.38	109,1	36	50	2.43	59,5
10677-20-20	1-1/4	1-5/8x12	1-1/4	4.86	123,5	46	50	2.59	65,8
10677-20-20C	1-1/4	1-5/8x12	1-1/4	4.92	125,0	46	60	2.65	67,3
10677-24-20	1-1/2	1-7/8x12	1-1/4	4.98	126,5	46	60	2.71	68,6
10677-24-24	1-1/2	1-7/8x12	1-1/2	5.34	135,7	50	60	2.95	75,0
10677-24-24C	1-1/2	1-7/8x12	1-1/2	5.55	140,9	50	65	3.16	80,3
10677-32-32	2	2-1/2x12	2	6.29	159,8	65	75	3.54	89,9
10677-32-32C*	2	2-1/2x12	2	6.29	159,8	65	75	3.54	89,9

All sizes of 10677 fittings are rated at 5,000 psi working pressure.

"C" suffix indicates stainless steel part. Some stainless steel parts are dimensionally different than the standard part.

\*This specific size in stainless is not able to be crimped in any Parkrimp machine.

**WARNING:** This product can expose you to chemicals including Lead, which is known to the State of California to cause cancer and birth defects or other reproductive harm. For more information go to [www.p65warnings.ca.gov](http://www.p65warnings.ca.gov).

See Accessories Section for O-Rings and Flange Kits.

**Refer to Pressure Rating of Hose End Connections Chart on page E-47.**

# 13777

## Female JIC 37° - Swivel - 45° Elbow - Short Drop

ISO 12151-5

# Part Number	Thread		Hose I.D. inch	A		E		W mm	B	
	inch	3/4x16		inch	mm	inch	mm		inch	mm
13777-8-8	1/2	3/4x16	1/2	2.86	72,7	0.59	15	22	1.64	41,8
13777-8-8C	1/2	3/4x16	1/2	2.86	72,7	0.59	15	22	1.64	41,8
13777-10-8	5/8	7/8x14	1/2	3.06	77,8	0.63	16	27	1.84	46,8
13777-10-10	5/8	7/8x14	5/8	3.40	86,3	0.63	16	27	2.05	52,1
13777-12-12	3/4	1-1/16x12	3/4	4.37	110,9	0.83	21	32	2.73	69,4
13777-12-12C	3/4	1-1/16x12	3/4	4.37	110,9	0.83	21	32	2.73	69,4
13777-16-12	1	1-5/16x12	3/4	4.49	114,0	0.94	24	41	2.85	72,5
13777-16-16	1	1-5/16x12	1	4.76	120,8	0.94	24	41	2.81	71,3
13777-20-20	1-1/4	1-5/8x12	1-1/4	5.92	150,3	1.26	32	50	3.64	92,6
13777-32-32*	2	2-1/2x12	2	8.58	218,0	2.20	56	75	5.83	148,1

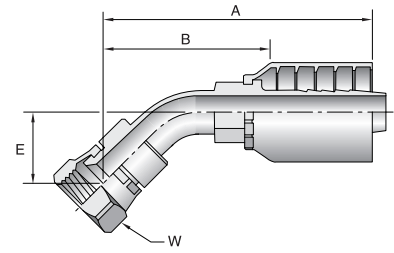

view on web page

All sizes of 13777 fittings are rated at 5,000 psi working pressure.

"C" suffix indicates stainless steel part. Some stainless steel parts are dimensionally different than the standard part.

\*This specific size is not able to be crimped in any Parkrimp machine.

**WARNING:** This product can expose you to chemicals including Lead, which is known to the State of California to cause cancer and birth defects or other reproductive harm. For more information go to [www.p65warnings.ca.gov](http://www.p65warnings.ca.gov).

# 13977

## Female JIC 37° - Swivel - 90° Elbow - Short Drop

ISO 12151-5

# Part Number	Thread		Hose I.D. inch	A		E		W mm	B	
	inch	3/4x16		inch	mm	inch	mm		inch	mm
13977-8-8	1/2	3/4x16	1/2	2.78	70,7	1.14	29,0	22	1.56	39,7
13977-8-8C	1/2	3/4x16	1/2	2.78	70,7	1.14	29,0	22	1.56	39,7
13977-10-8	5/8	7/8x14	1/2	2.77	70,5	1.26	32,0	27	1.55	39,5
13977-10-10	5/8	7/8x14	5/8	3.21	81,5	1.26	32,0	27	1.86	47,3
13977-12-10	3/4	1-1/16x12	5/8	3.21	81,5	1.89	48,0	32	1.86	47,3
13977-12-12	3/4	1-1/16x12	3/4	4.23	107,4	1.89	48,0	32	2.60	66,0
13977-12-12C	3/4	1-1/16x12	3/4	4.23	107,4	1.89	48,0	32	2.60	66,0
13977-16-12	1	1-5/16x12	3/4	4.23	107,4	2.93	74,5	41	2.59	65,9
13977-16-16	1	1-5/16x12	1	4.65	118,1	2.93	74,4	41	2.70	68,6
13977-16-16C	1	1-5/16x12	1	4.72	119,9	2.93	74,4	46	2.77	70,4
13977-20-20	1-1/4	1-5/8x12	1-1/4	5.35	136,0	3.07	78,0	50	3.08	78,3
13977-20-20C	1-1/4	1-5/8x12	1-1/4	6.28	159,5	3.07	78,0	60	4.01	101,8
13977-24-24	1-1/2	1-7/8x12	1-1/2	6.24	158,45	3.39	86,0	60	3.85	97,75
13977-32-32	2	2-1/2x12	2	8.75	222,1	5.51	140,0	75	5.99	152,2

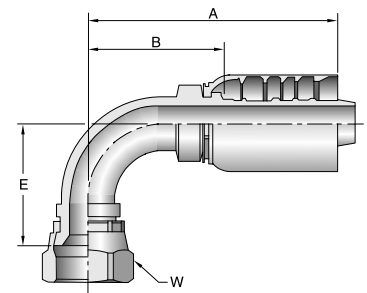

view on web page

All sizes of 13977 fittings are rated at 5,000 psi working pressure.

"C" suffix indicates stainless steel part. Some stainless steel parts are dimensionally different than the standard part.

**WARNING:** This product can expose you to chemicals including Lead, which is known to the State of California to cause cancer and birth defects or other reproductive harm. For more information go to [www.p65warnings.ca.gov](http://www.p65warnings.ca.gov).

See Accessories Section for O-Rings and Flange Kits.

**Refer to Pressure Rating of Hose End Connections Chart on page E-47.**

# 14177

## Female JIC 37° - Swivel - 90° Elbow - Long Drop

ISO 12151-5

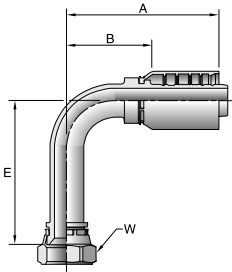

view on web page

# Part Number	Thread		Hose I.D. inch	A		E		W mm	B		Additional Material Stainless Steel (C)
	inch			inch	mm	inch	mm		inch	mm	
14177-8-8	1/2	3/4x16	1/2	2.78	70,7	2.52	64,0	22	1.56	39,7	●
14177-12-12	3/4	1-1/16x12	3/4	4.24	107,6	3.78	96,0	32	2.60	66,1	
14177-16-16	1	1-5/16x12	1	4.65	118,1	4.49	114,0	41	2.70	68,6	

All sizes of 14177 fittings are rated at 5,000 psi working pressure.

**WARNING:** This product can expose you to chemicals including Lead, which is known to the State of California to cause cancer and birth defects or other reproductive harm. For more information go to [www.p65warnings.ca.gov](http://www.p65warnings.ca.gov).

# 10577

## Male SAE Thread with O-Ring - Rigid

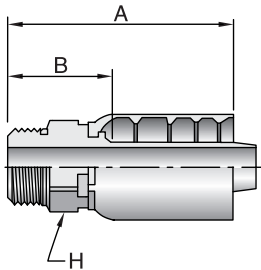

view on web page

# Part Number	Thread		Hose I.D. inch	A		H mm	B		Additional Material Stainless Steel (C)
	inch			inch	mm		inch	mm	
10577-8-8	1/2	3/4x16	1/2	2.39	60,8	22	1.17	29,8	●
10577-12-12	3/4	1-1/16x12	3/4	3.17	80,5	32	1.53	38,9	●
10577-16-16	1	1-5/16x12	1	3.73	94,7	41	1.78	45,2	
10577-20-20	1-1/4	1-5/8x12	1-1/4	4.17	105,9	50	1.90	48,2	
10577-32-20	2	2-1/2x12	1-1/4	4.35	110,5	2-3/4	2.08	52,8	

**WARNING:** This product can expose you to chemicals including Lead, which is known to the State of California to cause cancer and birth defects or other reproductive harm. For more information go to [www.p65warnings.ca.gov](http://www.p65warnings.ca.gov).

# 1X577

## Full Flange - Code 61/62

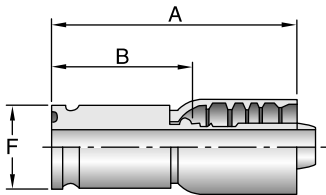

view on web page

# Part Number	Flange inch	Hose I.D. inch	A		F inch	B	
			inch	mm		inch	mm
1X577-8-8	1/2	1/2	2.44	62,1	1.02	1.22	31,1
1X577-12-12	3/4	3/4	4.06	103,0	1.37	2.42	61,6
1X577-16-12	1	3/4	4.06	103,0	1.54	2.42	61,6
1X577-16-16	1	1	4.45	113,0	1.54	2.50	63,5
1X577-16-20	1	1-1/4	4.73	120,2	1.54	2.46	62,5
1X577-20-16	1-1/4	1	4.45	113,0	1.81	2.50	63,5
1X577-20-20	1-1/4	1-1/4	4.73	120,2	1.81	2.46	62,5
1X577-24-20	1-1/2	1-1/4	4.85	123,2	2.21	2.58	65,5
1X577-24-24	1-1/2	1-1/2	5.07	128,8	2.21	2.68	68,1
1X577-32-32	2	2	6.08	154,4	2.60	3.32	84,3

**WARNING:** This product can expose you to chemicals including Lead, which is known to the State of California to cause cancer and birth defects or other reproductive harm. For more information go to [www.p65warnings.ca.gov](http://www.p65warnings.ca.gov).

See Accessories Section for O-Rings and Flange Kits.

**Refer to Pressure Rating of Hose End Connections Chart on page E-47.**

# 1X777

## Full Flange - 45° Elbow - Code 61/62

# Part Number	Flange inch	Hose I.D. inch	A		E		F inch	B	
			inch	mm	inch	mm		inch	mm
1X777-12-12	3/4	3/4	4.67	118,5	1.12	28,5	1.37	3.03	77,0
1X777-16-12	1	3/4	4.66	118,3	1.12	28,5	1.54	3.02	76,8
1X777-16-16	1	1	5.07	128,8	1.26	32,0	1.54	3.12	79,3
1X777-16-20	1	1-1/4	5.71	145,0	1.50	38,0	1.54	3.44	87,3
1X777-20-16	1-1/4	1	5.31	134,8	1.50	38,0	1.81	3.36	85,3
1X777-20-20	1-1/4	1-1/4	6.23	158,3	1.58	40,0	1.81	3.96	100,6
1X777-24-20	1-1/2	1-1/4	6.38	162,2	1.73	44,0	2.21	4.11	104,5
1X777-24-24	1-1/2	1-1/2	7.14	181,35	1.97	50,0	2.21	4.75	120,65

**WARNING:** This product can expose you to chemicals including Lead, which is known to the State of California to cause cancer and birth defects or other reproductive harm. For more information go to [www.p65warnings.ca.gov](http://www.p65warnings.ca.gov).

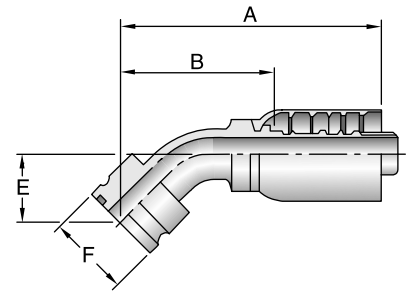

view on web page

# 1X977

## Full Flange - 90° Elbow - Code 61/62

# Part Number	Flange inch	Hose I.D. inch	A		E		F inch	B	
			inch	mm	inch	mm		inch	mm
1X977-8-8	1/2	1/2	3.14	79,8	1.69	43,0	1.02	1.92	48,9
1X977-12-12	3/4	3/4	4.24	107,6	2.38	60,5	1.37	2.60	66,1
1X977-12-16	3/4	1	4.33	109,9	2.76	70,0	1.37	2.38	60,5
1X977-16-12	1	3/4	4.24	107,6	2.38	60,5	1.54	2.60	66,1
1X977-16-16	1	1	4.65	118,1	2.76	70,0	1.54	2.70	68,6
1X977-16-20	1	1-1/4	5.44	138,2	3.54	90,0	1.54	3.17	80,5
1X977-20-16	1-1/4	1	4.65	118,1	3.54	90,0	1.81	2.70	68,6
1X977-20-20	1-1/4	1-1/4	5.35	136,0	3.54	90,0	1.81	3.08	78,3
1X977-24-20	1-1/2	1-1/4	5.35	136,0	4.09	104,0	2.21	3.08	78,3
1X977-24-24	1-1/2	1-1/2	6.24	158,45	4.09	104,0	2.21	3.85	97,75
1X977-32-32	2	2	8.75	222,1	5.43	138,0	2.60	5.99	152,2

**WARNING:** This product can expose you to chemicals including Lead, which is known to the State of California to cause cancer and birth defects or other reproductive harm. For more information go to [www.p65warnings.ca.gov](http://www.p65warnings.ca.gov).

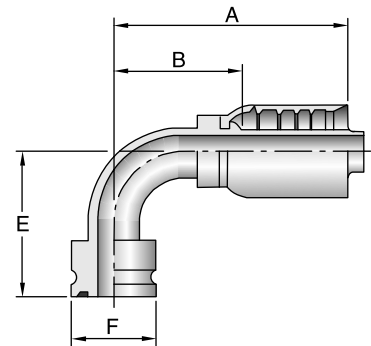

view on web page

See Accessories Section for O-Rings and Flange Kits.

**Refer to Pressure Rating of Hose End Connections Chart on page E-47**

# 11577

## SAE Code 61 Flange Head

### ISO 12151-3-S-L

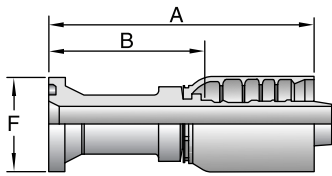

view on web page

# Part Number	Flange inch	Hose I.D. inch	A		F inch	B		Additional Material Stainless Steel (C)
			inch	mm		inch	mm	
11577-8-8	1/2	1/2	3.52	89,6	1-3/16	2.30	58,6	●
11577-10-10	5/8	5/8	3.90	99,0	1-11/32	2.55	64,8	
11577-12-8	3/4	1/2	2.52	64,0	1-1/2	1.30	33,0	
11577-12-12	3/4	3/4	4.23	107,4	1-1/2	2.59	65,9	●
11577-12-16	3/4	1	4.70	119,4	1-1/2	2.75	69,8	
11577-16-12	1	3/4	3.27	82,9	1-3/4	1.63	41,5	
11577-16-16	1	1	4.70	119,4	1-3/4	2.75	69,9	
11577-16-20	1	1-1/4	5.11	129,8	1-3/4	2.84	72,1	
11577-20-12	1-1/4	3/4	3.66	92,9	2	2.31	58,6	
11577-20-20	1-1/4	1-1/4	5.42	137,7	2	3.15	80,0	
11577-20-24	1-1/4	1-1/2	5.76	146,3	2	3.37	85,6	
11577-24-16	1-1/2	1	3.78	96,0	2-3/8	1.83	46,5	
11577-24-20	1-1/2	1-1/4	3.94	100,1	2-3/8	1.67	42,4	
11577-24-24	1-1/2	1-1/2	5.52	140,2	2-3/8	3.13	79,5	
11577-24-32	1-1/2	2	6.42	162,9	2-3/8	3.66	93,0	
11577-32-24	2	1-1/2	4.59	116,6	2-13/16	2.20	55,9	
11577-32-32*	2	2	6.43	163,2	2-13/16	3.67	93,2	
11577-40-32	2-1/2	2	5.28	133,9	3-5/16	2.52	64,0	

\*This specific size in stainless is not able to be crimped in any Parkrimp machine.

**WARNING:** This product can expose you to chemicals including Lead, which is known to the State of California to cause cancer and birth defects or other reproductive harm. For more information go to [www.p65warnings.ca.gov](http://www.p65warnings.ca.gov).

# 14A77

## SAE Code 61 Special Flange Head - 5,000\* psi

### ISO 12151-3-S-L

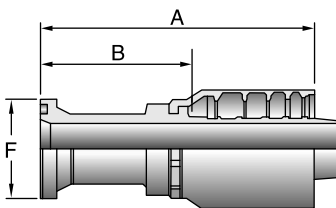

view on web page

# Part Number	Flange inch	Hose I.D. inch	A		F inch	B	
			inch	mm		inch	mm
14A77-20-12	1-1/4	3/4	3.66	92,9	2	2.02	51,4
14A77-20-16	1-1/4	1	3.54	89,9	2	1.59	40,4
14A77-20-20	1-1/4	1-1/4	5.42	137,7	2	3.15	80,0
14A77-20-24	1-1/4	1-1/2	5.76	146,3	2	3.37	85,6
14A77-24-16	1-1/2	1	3.78	96,0	2-3/8	1.83	46,5
14A77-24-20	1-1/2	1-1/4	3.94	100,1	2-3/8	1.67	42,4
14A77-24-24	1-1/2	1-1/2	5.52	140,2	2-3/8	3.13	79,6
14A77-24-32	1-1/2	2	6.42	162,9	2-3/8	3.66	93,0
14A77-32-24	2	1-1/2	4.59	116,6	2-13/16	2.20	55,9
14A77-32-32	2	2	6.43	163,3	2-13/16	3.67	93,2

\*Must be used with 5050HK Flange Kits

**WARNING:** This product can expose you to chemicals including Lead, which is known to the State of California to cause cancer and birth defects or other reproductive harm. For more information go to [www.p65warnings.ca.gov](http://www.p65warnings.ca.gov).

See Accessories Section for O-Rings and Flange Kits.

**Refer to Pressure Rating of Hose End Connections Chart on page E-47.**

# 11677

## SAE Code 61 Flange Head - 22-1/2° Elbow

ISO 12151-3-E22M-L

# Part Number	Flange inch	Hose I.D. inch	A		E		F inch	B	
			inch	mm	inch	mm		inch	mm
11677-12-12	3/4	3/4	4.84	122,9	0.43	11,0	1-1/2	3.20	81,4
11677-16-12	1	3/4	4.84	122,9	0.43	11,0	1-3/4	3.20	81,4
11677-16-16	1	1	5.42	137,6	0.55	14,0	1-3/4	3.47	88,1
11677-20-16	1-1/4	1	5.74	145,9	0.59	15,0	2	3.80	96,4
11677-20-20	1-1/4	1-1/4	6.65	169,0	0.59	15,0	2	4.38	111,3
11677-24-20	1-1/2	1-1/4	6.96	176,8	0.71	18,0	2-3/8	4.69	119,1
11677-24-24	1-1/2	1-1/2	7.45	189,35	0.71	18,0	2-3/8	5.06	128,65
11677-32-24	2	1-1/2	8.09	205,55	0.87	22,0	2-13/16	5.70	144,85
11677-32-32	2	2	9.12	231,7	0.87	22,0	2-13/16	6.37	161,7

**WARNING:** This product can expose you to chemicals including Lead, which is known to the State of California to cause cancer and birth defects or other reproductive harm. For more information go to [www.p65warnings.ca.gov](http://www.p65warnings.ca.gov).

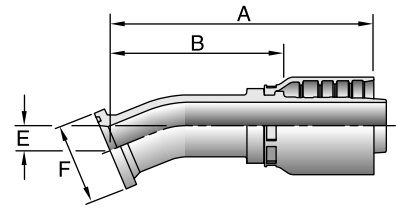

view on web page

# 14B77

## SAE Code 61 Special Flange Head - 22-1/2° Elbow - 5,000\* psi

ISO 12151-3-E22M-L

# Part Number	Flange inch	Hose I.D. inch	A		E		F inch	B	
			inch	mm	inch	mm		inch	mm
14B77-20-20	1-1/4	1-1/4	6.65	169,0	0.59	15,0	2	4.38	111,3
14B77-24-24	1-1/2	1-1/2	7.45	189,35	0.71	18,0	2-3/8	5.06	128,65
14B77-32-32	2	2	9.12	231,7	0.87	22,0	2-13/16	6.37	161,7

\*Must be used with 5050HK Flange Kits

**WARNING:** This product can expose you to chemicals including Lead, which is known to the State of California to cause cancer and birth defects or other reproductive harm. For more information go to [www.p65warnings.ca.gov](http://www.p65warnings.ca.gov).

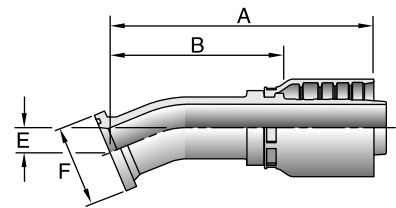

view on web page

# 12677

## SAE Code 61 Flange Head - 30° Elbow

ISO 12151-3-E30M-L

# Part Number	Flange inch	Hose I.D. inch	A		E		F inch	B	
			inch	mm	inch	mm		inch	mm
12677-12-12	3/4	3/4	4.77	121,1	0.63	16,0	1-1/2	3.13	79,6
12677-20-16	1-1/4	1	5.64	143,3	0.87	22,0	2	3.69	93,8
12677-20-20	1-1/4	1-1/4	6.53	165,9	0.87	22,0	2	4.26	108,2
12677-24-24	1-1/2	1-1/2	7.28	184,85	1.18	30,0	2-3/8	4.89	124,15
12677-32-24	2	1-1/2	7.92	201,25	1.26	32,0	2-13/16	5.53	140,55
12677-32-32	2	2	9.01	228,9	1.26	32,0	2-13/16	6.26	159,0

**WARNING:** This product can expose you to chemicals including Lead, which is known to the State of California to cause cancer and birth defects or other reproductive harm. For more information go to [www.p65warnings.ca.gov](http://www.p65warnings.ca.gov).

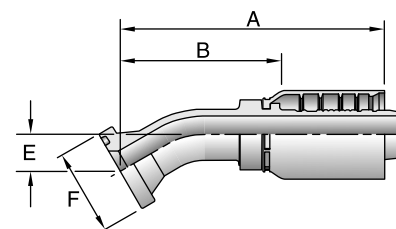

view on web page

See Accessories Section for O-Rings and Flange Kits.

**Refer to Pressure Rating of Hose End Connections Chart on page E-47.**

# 14E77

SAE Code 61 Special Flange Head - 30° Elbow - 5,000 psi  
ISO 12151-3-E30S-L

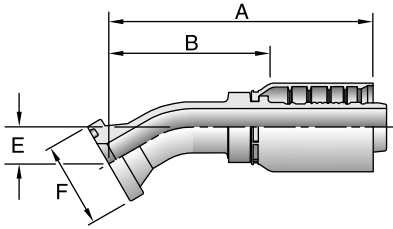

# Part Number	Flange inch	Hose I.D. inch	A		E		F	B	
			inch	mm	inch	mm	inch	inch	mm
14E77-24-24	1-1/2	1-1/2	7.28	184.85	1.18	30	2-3/8	4.89	124.15
14E77-32-32	2	2	9.01	228,9	1.26	32	2-13/16	6.26	159,0

Must be used with 5050HK Flange Kits

**WARNING:** This product can expose you to chemicals including Lead, which is known to the State of California to cause cancer and birth defects or other reproductive harm. For more information go to [www.p65warnings.ca.gov](http://www.p65warnings.ca.gov).

view on web page

# 11777

SAE Code 61 Flange Head - 45° Elbow  
ISO 12151-3-E45M-L

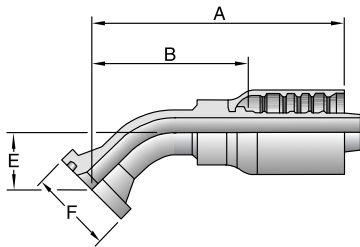

# Part Number	Flange inch	Hose I.D. inch	A		E		F	B	
			inch	mm	inch	mm	inch	inch	mm
11777-8-8	1/2	1/2	3.11	79,0	0.79	20,0	1-3/16	1.89	48,0
11777-12-8	3/4	1/2	3.33	84,7	0.87	22,0	1-1/2	2.11	53,7
11777-12-12	3/4	3/4	4.57	116,0	1.02	26,0	1-1/2	2.93	74,5
11777-16-12	1	3/4	4.57	116,0	1.02	26,0	1-3/4	2.93	74,5
11777-16-16	1	1	5.07	128,8	1.26	32,0	1-3/4	3.12	79,3
11777-16-20	1	1-1/4	5.71	145,0	1.50	38,0	1-3/4	3.44	87,3
11777-20-16	1-1/4	1	5.31	134,8	1.50	38,0	2	3.36	85,3
11777-20-20	1-1/4	1-1/4	6.15	156,2	1.50	38,0	2	3.88	98,5
11777-24-20	1-1/2	1-1/4	6.38	162,2	1.73	44,0	2-3/8	4.11	104,5
11777-24-24	1-1/2	1-1/2	6.90	175.35	1.73	44,0	2-3/8	4.51	114.65
11777-32-24	2	1-1/2	7.38	187.35	2.20	56,0	2-13/16	4.99	126.65
11777-32-32	2	2	8.58	218,0	2.20	56,0	2-13/16	5.83	148,1

**WARNING:** This product can expose you to chemicals including Lead, which is known to the State of California to cause cancer and birth defects or other reproductive harm. For more information go to [www.p65warnings.ca.gov](http://www.p65warnings.ca.gov).

view on web page

See Accessories Section for O-Rings and Flange Kits.

**Refer to Pressure Rating of Hose End Connections Chart on page E-47.**



# 14F77

## SAE Code 61 Special Flange Head - 45° - 5,000\* psi

ISO 12151-3-E45M-L

# Part Number	Flange inch	Hose I.D. inch	A		E		F	B	
			inch	mm	inch	mm		inch	mm
14F77-20-16	1-1/4	1	5.31	134,8	1.50	38,0	2	3.36	85,3
14F77-20-20	1-1/4	1-1/4	6.15	156,2	1.50	38,0	2	3.88	98,5
14F77-20-24	1-1/4	1-1/2	6.72	170.75	1.73	44,0	2	4.33	110.05
14F77-24-20	1-1/2	1-1/4	6.38	162,2	1.73	44,0	2-3/8	4.11	104,5
14F77-24-24	1-1/2	1-1/2	6.90	175.35	1.73	44,0	2-3/8	4.51	114.65
14F77-32-24	2	1-1/2	7.38	187.35	2.20	56,0	2-13/16	4.99	126.65
14F77-32-32	2	2	8.58	218,0	2.20	56,0	2-13/16	5.83	148,1

\*Must be used with 5050HK Flange Kits

**WARNING:** This product can expose you to chemicals including Lead, which is known to the State of California to cause cancer and birth defects or other reproductive harm. For more information go to [www.p65warnings.ca.gov](http://www.p65warnings.ca.gov).

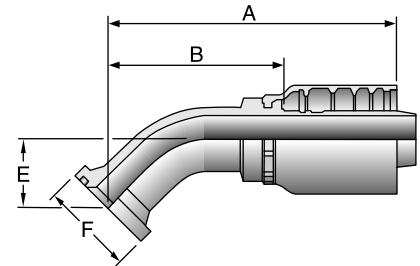

[view on web page](#)

# 12777

## SAE Code 61 Flange Head - 60° Elbow

ISO 12151-3-E60M-L

# Part Number	Flange inch	Hose I.D. inch	A		E		F	B	
			inch	mm	inch	mm		inch	mm
12777-12-12	3/4	3/4	5.27	133,8	1.46	37,0	1-1/2	3.63	92,3
12777-16-12	1	3/4	5.27	133,8	1.46	37,0	1-3/4	3.63	92,3
12777-16-16	1	1	5.91	150,2	1.73	44,0	1-3/4	3.96	100,7
12777-20-20	1-1/4	1-1/4	7.05	179,2	2.17	55,0	2	4.78	121,5
12777-24-20	1-1/2	1-1/4	7.40	188,1	2.52	64,0	2-3/8	5.13	130,4
12777-24-24	1-1/2	1-1/2	8.01	203.35	2.52	64,0	2-3/8	5.62	142.65
12777-32-32	2	2	8.74	222,1	3.27	83,0	2-13/16	5.99	152,1

\* This specific size is not able to be crimped in any Parkrimp machine.

**WARNING:** This product can expose you to chemicals including Lead, which is known to the State of California to cause cancer and birth defects or other reproductive harm. For more information go to [www.p65warnings.ca.gov](http://www.p65warnings.ca.gov).

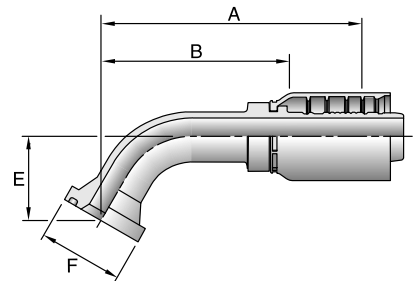

[view on web page](#)

See Accessories Section for O-Rings and Flange Kits.

**Refer to Pressure Rating of Hose End Connections Chart on page E-47.**

# 14G77

SAE Code 61 Special Flange Head - 60° Elbow - 5,000\* psi  
ISO 12151-3-E60M-L

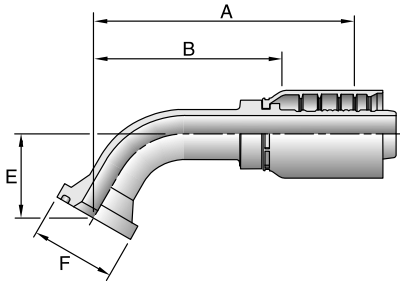

view on web page

# Part Number	Flange inch	Hose I.D. inch	A		E		F	B	
			inch	mm	inch	mm		inch	mm
14G77-20-16	1-1/4	1	5.97	151,6	1.73	44,0	2	4.02	102,1
14G77-24-24	1-1/2	1-1/2	8.14	206,65	2.52	64,0	2-3/8	5.75	145,95
14G77-32-32	2	2	8.74	222,1	3.27	83,0	2-13/16	5.99	152,1

\*Must be used with 5050HK Flange Kits

**WARNING:** This product can expose you to chemicals including Lead, which is known to the State of California to cause cancer and birth defects or other reproductive harm. For more information go to [www.p65warnings.ca.gov](http://www.p65warnings.ca.gov).

# 11877

SAE Code 61 Flange Head - 67-1/2° Elbow  
ISO 12151-3-E67M-L

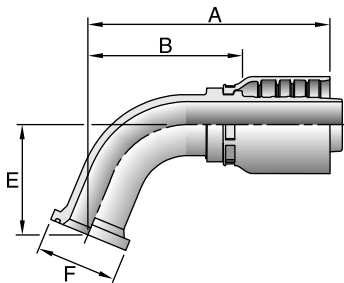

view on web page

# Part Number	Flange inch	Hose I.D. inch	A		E		F	B	
			inch	mm	inch	mm		inch	mm
11877-12-12	3/4	3/4	5.07	128,7	1.65	42,0	1-1/2	3.43	87,2
11877-16-12	1	3/4	5.07	128,7	1.65	42,0	1-3/4	3.43	87,2
11877-20-20	1-1/4	1-1/4	6.71	170,6	2.52	64,0	2	4.44	112,9
11877-24-20	1-1/2	1-1/4	7.01	178,0	2.91	74,0	2-3/8	4.73	120,3
11877-24-24	1-1/2	1-1/2	7.77	197,25	2.91	74,0	2-3/8	5.38	136,55
11877-32-24*	2	1-1/2	8.50	215,95	3.82	97,0	2-13/16	6.11	155,25
11877-32-32	2	2	8.72	221,4	3.82	97,0	2-13/16	5.97	151,5

\*This specific size is not able to be crimped in any Parkrimp machine.

**WARNING:** This product can expose you to chemicals including Lead, which is known to the State of California to cause cancer and birth defects or other reproductive harm. For more information go to [www.p65warnings.ca.gov](http://www.p65warnings.ca.gov).

See Accessories Section for O-Rings and Flange Kits.

**Refer to Pressure Rating of Hose End Connections Chart on page E-47.**

# 14M77

SAE Code 61 Special Flange Head - 67-1/2° Elbow - 5,000\* psi

# Part Number	Flange inch	Hose I.D. inch	A		E		F inch	B	
			inch	mm	inch	mm		inch	mm
14M77-24-24	1-1/2	1-1/2	7.77	199.25	2.91	74,0	2-3/8	5.38	136.55

\*Must be used with 5050HK Flange Kits

**WARNING:** This product can expose you to chemicals including Lead, which is known to the State of California to cause cancer and birth defects or other reproductive harm. For more information go to [www.p65warnings.ca.gov](http://www.p65warnings.ca.gov).

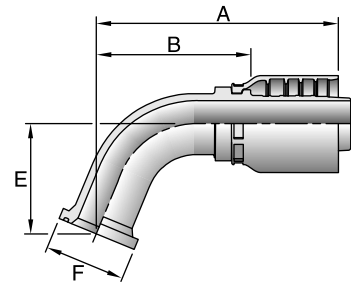

view on web page

# 11977

SAE Code 61 Flange Head - 90° Elbow

ISO 12151-3-E90M-L

# Part Number	Flange inch	Hose I.D. inch	A		E		F inch	B		Additional Material Stainless Steel (C)
			inch	mm	inch	mm		inch	mm	
11977-8-8	1/2	1/2	2.99	76,0	1.61	41,0	1-3/16	1.77	45,0	•
11977-10-10	5/8	5/8	3.62	91,9	2.09	53,0	1-11/32	2.27	57,7	
11977-12-8	3/4	1/2	2.77	70,5	1.61	41,0	1-1/2	1.55	39,5	
11977-12-10	3/4	5/8	3.40	86,3	2.09	53,0	1-1/2	2.05	52,1	
11977-12-12	3/4	3/4	4.24	107,6	2.28	58,0	1-1/2	2.60	66,1	•
11977-12-16	3/4	1	4.41	112,0	2.76	70,0	1-1/2	2.46	62,5	
11977-16-10	1	5/8	3.21	81,5	2.09	53,0	1-3/4	1.86	47,3	
11977-16-12	1	3/4	4.24	107,6	2.28	58,0	1-3/4	2.60	66,1	•
11977-16-16	1	1	4.65	118,1	2.76	70,0	1-3/4	2.70	68,6	
11977-16-16C	1	1	4.72	119,9	2.76	70,0	1-3/4	2.77	70,4	•
11977-16-20	1	1-1/4	5.05	128,3	3.54	90,0	1-3/4	2.78	70,6	
11977-20-12	1-1/4	3/4	4.23	107,4	2.28	58,0	2	2.59	65,9	
11977-20-16	1-1/4	1	4.65	118,1	3.54	90,0	2	2.70	68,6	
11977-20-20	1-1/4	1-1/4	5.35	136,0	3.54	90,0	2	3.08	78,3	
11977-20-24	1-1/4	1-1/2	5.69	144.55	4.09	104,0	2	3.30	83.85	
11977-24-16	1-1/2	1	4.65	118,1	2.76	70,0	2-3/8	2.70	68,6	
11977-24-20	1-1/2	1-1/4	5.35	136,0	4.09	104,0	2-3/8	3.08	78,3	
11977-24-24	1-1/2	1-1/2	6.24	158.45	4.09	104,0	2-3/8	3.85	97.75	
11977-32-24	2	1-1/2	6.24	158.45	5.43	138.00	2-13/16	3.85	97.75	
11977-32-32	2	2	8.75	222,1	5.43	138,0	2-13/16	5.99	152,2	

**WARNING:** This product can expose you to chemicals including Lead, which is known to the State of California to cause cancer and birth defects or other reproductive harm. For more information go to [www.p65warnings.ca.gov](http://www.p65warnings.ca.gov).

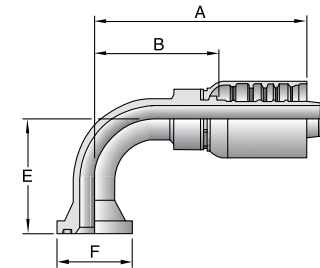

view on web page

See Accessories Section for O-Rings and Flange Kits.

**Refer to Pressure Rating of Hose End Connections Chart on page E-47.**

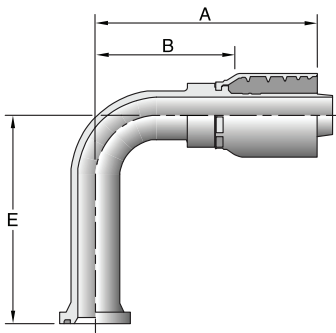

### 18977

SAE Code 61 Flange Head - 90° Elbow - Long Drop

# Part Number	Flange inch	Hose I.D. inch	A		E		F inch	B	
			inch	mm	inch	mm		inch	mm
18977-12-12	3/4	3/4	4.23	107,4	5.12	130,0	1-1/2	2.59	65,9
18977-16-16	1	1	4.65	118,1	4.60	116,8	1-3/4	2.70	68,6
18977-20-16	1-1/4	1	4.65	118,1	5.51	140,0	2	2.70	68,6

**WARNING:** This product can expose you to chemicals including Lead, which is known to the State of California to cause cancer and birth defects or other reproductive harm. For more information go to [www.p65warnings.ca.gov](http://www.p65warnings.ca.gov).

[view on web page](#)

### 14N77

SAE Code 61 Special Flange Head - 90° Elbow - 5,000\* psi  
ISO 12151-3-E90M-L

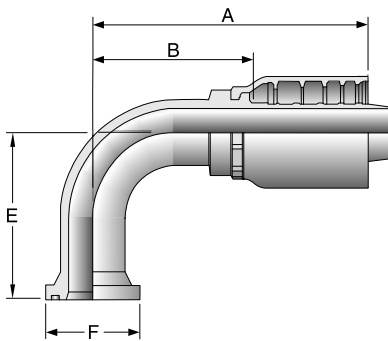

# Part Number	Flange inch	Hose I.D. inch	A		E		F inch	B		Additional Material Stainless Steel (C)
			inch	mm	inch	mm		inch	mm	
14N77-20-16	1-1/4	1	4.65	118,1	3.54	90,0	2	2.70	68,6	
14N77-20-20	1-1/4	1-1/4	5.35	136,0	3.54	90,0	2	3.08	78,3	
14N77-20-20C	1-1/4	1-1/4	6.28	159,5	3.54	90,0	2	4.00	101,8	●
14N77-24-20	1-1/2	1-1/4	5.35	136,0	4.09	104,0	2-3/8	3.08	78,3	
14N77-24-24	1-1/2	1-1/2	6.24	158.45	4.09	104,0	2-3/8	3.85	97.75	
14N77-24-32	1-1/2	2	7.65	194,2	5.43	138,0	2-3/8	4.89	124,2	
14N77-32-24	2	1-1/2	6.24	158.45	5.43	138,0	2-13/16	3.85	97.75	
14N77-32-32	2	2	8.75	222,1	5.43	138,0	2-13/16	5.99	152,2	

\*Must be used with 5050HK Flange Kits

**WARNING:** This product can expose you to chemicals including Lead, which is known to the State of California to cause cancer and birth defects or other reproductive harm. For more information go to [www.p65warnings.ca.gov](http://www.p65warnings.ca.gov).

[view on web page](#)

See Accessories Section for O-Rings and Flange Kits.

**Refer to Pressure Rating of Hose End Connections Chart on page E-47.**

# 16A77

## SAE Code 62 Flange Head

### ISO 12151-3-S-S

# Part Number	Flange inch	Hose I.D. inch	A		F inch	B		Additional Material Stainless Steel (C)
			inch	mm		inch	mm	
16A77-8-8	1/2	1/2	3.51	89,3	1-1/4	2.29	58,3	
16A77-8-10	1/2	5/8	3.83	97,3	1-1/4	2.48	63,0	
16A77-12-10	3/4	5/8	2.95	74,9	1-5/8	1.60	40,7	
16A77-12-12	3/4	3/4	4.49	113,9	1-5/8	2.85	72,5	●
16A77-12-16	3/4	1	4.96	126,0	1-5/8	3.01	76,5	
16A77-16-12	1	3/4	3.47	88,1	1-7/8	1.83	46,6	
16A77-16-16	1	1	4.45	113,0	1-7/8	2.50	63,5	●
16A77-16-20	1	1-1/4	5.66	143,8	1-7/8	3.39	86,1	●
16A77-20-16	1-1/4	1	4.05	102,9	2-1/8	2.10	53,4	●
16A77-20-20	1-1/4	1-1/4	5.73	145,6	2-1/8	3.46	87,8	●
16A77-20-24	1-1/4	1-1/2	6.06	153,9	2-1/8	3.67	93,2	
16A77-24-16	1-1/2	1	4.25	108,0	2-1/2	2.30	58,4	
16A77-24-20	1-1/2	1-1/4	4.65	118,1	2-1/2	2.38	60,4	
16A77-24-24	1-1/2	1-1/2	6.39	162,3	2-1/2	4.00	101,6	●
16A77-32-24	2	1-1/2	5.23	132,8	3-1/8	2.84	72,2	
16A77-32-32*	2	2	7.17	182,1	3-1/8	4.41	112,0	●

\*This specific size in stainless is not able to be crimped in any Parkrimp machine.

**WARNING:** This product can expose you to chemicals including Lead, which is known to the State of California to cause cancer and birth defects or other reproductive harm. For more information go to [www.p65warnings.ca.gov](http://www.p65warnings.ca.gov).

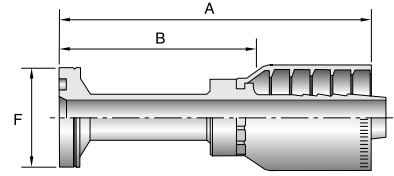

view on web page

# 16B77

## SAE Code 62 Flange Head - 22-1/2° Elbow

### ISO 12151-3-E22M-S

# Part Number	Flange inch	Hose I.D. inch	A		E		F inch	B	
			inch	mm	inch	mm		inch	mm
16B77-16-16	1	1	5.42	137,6	0.55	14,0	1-7/8	3.47	88,1
16B77-20-20	1-1/4	1-1/4	6.65	168,9	0.59	15,0	2-1/8	4.38	111,2
16B77-24-24	1-1/2	1-1/2	7.45	189,35	0.71	18,0	2-1/2	5.06	128,65
16B77-32-32	2	2	9.12	231,7	0.87	22,0	3-1/8	6.37	161,7

**WARNING:** This product can expose you to chemicals including Lead, which is known to the State of California to cause cancer and birth defects or other reproductive harm. For more information go to [www.p65warnings.ca.gov](http://www.p65warnings.ca.gov).

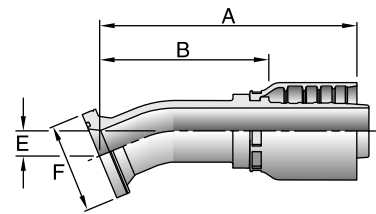

view on web page

See Accessories Section for O-Rings and Flange Kits.

**Refer to Pressure Rating of Hose End Connections Chart on page E-47.**

# 16E77

## SAE Code 62 Flange Head - 30° Elbow

ISO 12151-3-E30M-S

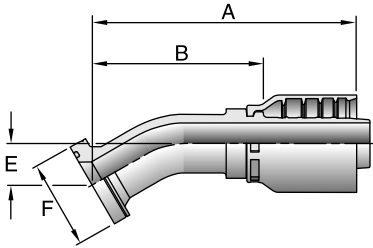

view on web page

# Part Number	Flange inch	Hose I.D. inch	A		E		F		B	
			inch	mm	inch	mm	inch	inch	mm	mm
16E77-12-12	3/4	3/4	4.77	121,1	0.63	16,0	1-5/8	3.13	79,6	
16E77-16-16	1	1	5.34	135,6	0.75	19,0	1-7/8	3.39	86,1	
16E77-20-20	1-1/4	1-1/4	6.53	165,9	0.87	22,0	2-1/8	4.26	108,2	
16E77-24-24	1-1/2	1-1/2	7.28	184,85	1.18	30,0	2-1/2	4.89	124,15	
16E77-32-24	2	1-1/2	7.93	201,35	1.26	32,0	3-1/8	5.54	140,65	
16E77-32-32	2	2	9.01	228,9	1.26	32,0	3-1/8	6.26	159,0	

**WARNING:** This product can expose you to chemicals including Lead, which is known to the State of California to cause cancer and birth defects or other reproductive harm. For more information go to [www.p65warnings.ca.gov](http://www.p65warnings.ca.gov).

# 16F77

## SAE Code 62 Flange Head - 45° Elbow

ISO 12151-3-E45M-S

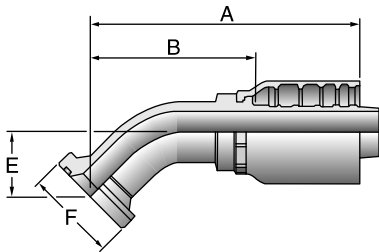

view on web page

# Part Number	Flange inch	Hose I.D. inch	A		E		F		B		Additional Material Stainless Steel (C)
			inch	mm	inch	mm	inch	inch	mm		
16F77-8-8	1/2	1/2	3.11	79,0	0.75	19,0	1-1/4	1.89	48,0		
16F77-12-10	3/4	5/8	3.77	95,7	1.00	25,5	1-5/8	2.42	61,5		
16F77-12-12	3/4	3/4	4.57	116,0	1.02	26,0	1-5/8	2.93	74,5		
16F77-12-16	3/4	1	4.98	126,5	1.26	32,0	1-5/8	3.03	77,0		
16F77-16-12	1	3/4	4.57	116,0	1.02	26,0	1-7/8	2.93	74,5		
16F77-16-16	1	1	5.07	128,8	1.26	32,0	1-7/8	3.12	79,3		
16F77-16-20	1	1-1/4	5.71	145,0	1.50	38,0	1-7/8	3.44	87,3		
16F77-20-16	1-1/4	1	5.31	134,8	1.50	38,0	2-1/8	3.36	85,3		
16F77-20-20	1-1/4	1-1/4	6.15	156,3	1.50	38,0	2-1/8	3.88	98,6		
16F77-20-20C	1-1/4	1-1/4	6.66	169,2	1.50	38,0	2-1/8	4.39	111,5	•	
16F77-24-20	1-1/2	1-1/4	6.38	162,2	1.73	44,0	2-1/2	4.11	104,5		
16F77-24-24	1-1/2	1-1/2	6.90	175,35	1.73	44,0	2-1/2	4.51	114,65		
16F77-32-24	2	1-1/2	7.38	187,35	2.20	56,0	3-1/8	4.99	126,65		
16F77-32-32*	2	2	8.58	218,0	2.20	56,0	3-1/8	5.83	148,1		

\*This specific size in stainless is not able to be crimped in any Parkrimp machine.

**WARNING:** This product can expose you to chemicals including Lead, which is known to the State of California to cause cancer and birth defects or other reproductive harm. For more information go to [www.p65warnings.ca.gov](http://www.p65warnings.ca.gov).

See Accessories Section for O-Rings and Flange Kits.

**Refer to Pressure Rating of Hose End Connections Chart on page E-47.**

# 16G77

## SAE Code 62 Flange Head - 60° Elbow

ISO 12151-3-E60M-S

# Part Number	Flange inch	Hose I.D. inch	A		E		F inch	B	
			inch	mm	inch	mm		inch	mm
16G77-12-12	3/4	3/4	5.27	133,8	1.46	37,0	1-5/8	3.63	92,3
16G77-16-16	1	1	5.91	150,1	1.73	44,0	1-7/8	3.96	100,6
16G77-24-24	1-1/2	1-1/2	8.14	206.65	2.52	64,0	2-1/2	5.75	145.95
16G77-32-32	2	2	8.74	222,1	3.27	83,0	3-1/8	5.99	152,1

**WARNING:** This product can expose you to chemicals including Lead, which is known to the State of California to cause cancer and birth defects or other reproductive harm. For more information go to [www.p65warnings.ca.gov](http://www.p65warnings.ca.gov).

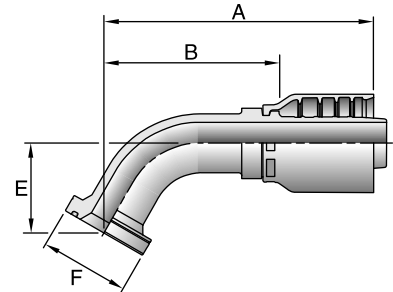

[view on web page](#)

# 16N77

## SAE Code 62 Flange Head - 90° Elbow

ISO 12151-3 - E90M - S

# Part Number	Flange inch	Hose I.D. inch	A		E		F inch	B		Additional Material Stainless Steel (C)
			inch	mm	inch	mm		inch	mm	
16N77-8-8	1/2	1/2	2.77	70,5	1.61	41,0	1-1/4	1.55	39,5	
16N77-8-10	1/2	5/8	3.09	78,5	2.13	54,0	1-1/4	1.74	44,2	
16N77-12-12	3/4	3/4	4.24	107,6	2.28	58,0	1-5/8	2.60	66,1	●
16N77-12-16	3/4	1	4.41	112,0	2.76	70,0	1-5/8	2.46	62,5	
16N77-16-12	1	3/4	4.24	107,6	2.28	58,0	1-7/8	2.60	66,1	
16N77-16-16	1	1	4.65	118,1	2.76	70,0	1-7/8	2.70	68,6	
16N77-16-16C	1	1	4.72	119,9	2.76	70,0	1-7/8	2.77	70,4	●
16N77-16-20	1	1-1/4	5.05	128,3	3.54	90,0	1-7/8	2.78	70,6	
16N77-16-20C	1	1-1/4	5.44	138,2	3.54	90,0	1-7/8	3.17	80,5	●
16N77-20-16	1-1/4	1	4.65	118,1	3.54	90,0	2-1/8	2.70	68,6	
16N77-20-20	1-1/4	1-1/4	5.35	136,0	3.54	90,0	2-1/8	3.08	78,3	
16N77-20-20C	1-1/4	1-1/4	6.28	159,5	3.54	90,0	2-1/8	4.00	101,8	●
16N77-20-24	1-1/4	1-1/2	5.69	144.55	4.09	104,0	2-1/8	3.30	83.85	
16N77-24-20	1-1/2	1-1/4	5.35	136,0	4.09	104,0	2-1/2	3.08	78,3	
16N77-24-20C	1-1/2	1-1/4	6.28	159,5	4.09	104,0	2-1/2	4.00	101,8	●
16N77-24-24	1-1/2	1-1/2	6.24	158.45	4.09	104,0	2-1/2	3.85	97.75	●
16N77-32-24	2	1-1/2	6.24	158.45	5.43	138.00	3-1/8	3.85	97.75	●
16N77-32-32*	2	2	8.75	222,1	5.43	138,0	3-1/8	5.99	152,2	●

\*This specific size in stainless is not able to be crimped in any Parkrimp machine.

**WARNING:** This product can expose you to chemicals including Lead, which is known to the State of California to cause cancer and birth defects or other reproductive harm. For more information go to [www.p65warnings.ca.gov](http://www.p65warnings.ca.gov).

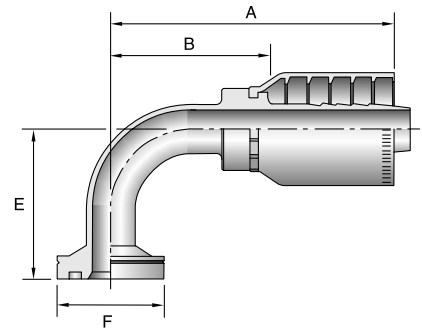

[view on web page](#)

See Accessories Section for O-Rings and Flange Kits.

**Refer to Pressure Rating of Hose End Connections Chart on page E-47.**

## 1XA77 Caterpillar® Flange Head

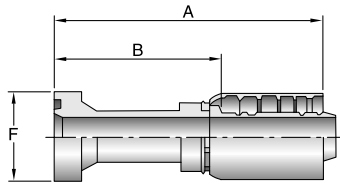

view on web page

# Part Number	Flange inch	Hose I.D. inch	A		F		B	
			inch	mm	inch	inch	mm	
1XA77-12-12	3/4	3/4	4.48	113,7	1-5/8	2.84	72,2	
1XA77-12-16	3/4	1	4.96	126,0	1-5/8	3.01	76,5	
1XA77-16-12	1	3/4	3.47	88,1	1-7/8	1.83	46,6	
1XA77-16-16	1	1	5.54	140,7	1-7/8	3.59	91,2	
1XA77-20-16	1-1/4	1	4.10	104,1	2-1/8	2.15	54,6	
1XA77-20-20	1-1/4	1-1/4	5.98	151,9	2-1/8	3.71	94,2	
1XA77-20-24	1-1/4	1-1/2	6.32	160,5	2-1/8	3.93	99,8	
1XA77-24-20	1-1/2	1-1/4	4.65	118,1	2-1/2	2.38	60,4	
1XA77-24-24	1-1/2	1-1/2	6.94	176,3	2-1/2	4.55	115,6	
1XA77-32-32	2	2	7.56	191,9	3-1/8	4.80	121,9	

**WARNING:** This product can expose you to chemicals including Lead, which is known to the State of California to cause cancer and birth defects or other reproductive harm. For more information go to [www.p65warnings.ca.gov](http://www.p65warnings.ca.gov).

## 1XB77 Caterpillar® Flange Head - 22-1/2° Elbow

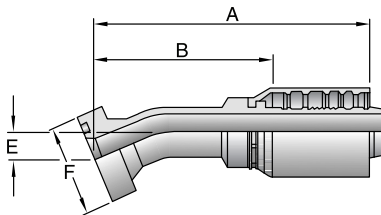

view on web page

# Part Number	Flange inch	Hose I.D. inch	A		E		F		B	
			inch	mm	inch	mm	inch	inch	mm	
1XB77-12-12	3/4	3/4	5.09	129,2	0.55	14,0	1-5/8	3.45	87,7	
1XB77-16-12	1	3/4	5.09	129,2	0.55	14,0	1-7/8	3.45	87,7	
1XB77-16-16	1	1	5.64	143,2	0.55	14,0	1-7/8	3.69	93,7	
1XB77-20-16	1-1/4	1	5.64	143,3	0.55	14,0	2-1/8	3.69	93,8	
1XB77-20-20	1-1/4	1-1/4	6.58	167,1	0.67	17,0	2-1/8	4.31	109,4	
1XB77-24-24	1-1/2	1-1/2	7.51	190,75	0.71	18,0	2-1/2	5.12	130,05	
1XB77-32-32	2	2	9.12	231,7	0.87	22,0	3-1/8	6.37	161,7	

**WARNING:** This product can expose you to chemicals including Lead, which is known to the State of California to cause cancer and birth defects or other reproductive harm. For more information go to [www.p65warnings.ca.gov](http://www.p65warnings.ca.gov).

See Accessories Section for O-Rings and Flange Kits.

**Refer to Pressure Rating of Hose End Connections Chart on page E-47.**



# 1XE77

## Caterpillar® Flange Head - 30° Elbow

# Part Number	Flange inch	Hose I.D. inch	A		E		F inch	B	
			inch	mm	inch	mm		inch	mm
1XE77-12-12	3/4	3/4	5.00	126,9	0.83	21,0	1-5/8	3.36	85,4
1XE77-16-12	1	3/4	5.02	127,4	0.75	19,0	1-7/8	3.38	86,0
1XE77-16-16	1	1	5.56	141,3	0.75	19,0	1-7/8	3.61	91,8
1XE77-20-16	1-1/4	1	5.53	140,4	0.87	22,0	2-1/8	3.58	90,9
1XE77-20-20	1-1/4	1-1/4	6.45	163,9	0.94	24,0	2-1/8	4.18	106,2
1XE77-24-24	1-1/2	1-1/2	7.33	186,25	1.18	30,0	2-1/2	4.94	125,55
1XE77-32-32	2	2	9.01	228,9	1.26	32,0	3-1/8	6.26	159,0

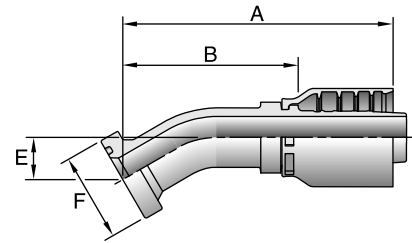

[view on web page](#)

**WARNING:** This product can expose you to chemicals including Lead, which is known to the State of California to cause cancer and birth defects or other reproductive harm. For more information go to [www.p65warnings.ca.gov](http://www.p65warnings.ca.gov).

# 1XF77

## Caterpillar® Flange Head - 45° Elbow

# Part Number	Flange inch	Hose I.D. inch	A		E		F inch	B	
			inch	mm	inch	mm		inch	mm
1XF77-12-12	3/4	3/4	4.76	120,8	1.22	31,0	1-5/8	3.12	79,3
1XF77-16-12	1	3/4	4.76	120,8	1.22	31,0	1-7/8	3.12	79,3
1XF77-16-16	1	1	5.23	132,8	1.42	36,0	1-7/8	3.28	83,3
1XF77-20-16	1-1/4	1	5.23	132,8	1.42	36,0	2-1/8	3.28	83,3
1XF77-20-20	1-1/4	1-1/4	6.11	155,2	1.46	37,0	2-1/8	3.84	97,5
1XF77-24-20	1-1/2	1-1/4	6.11	155,2	1.46	37,0	2-1/2	3.84	97,5
1XF77-24-24	1-1/2	1-1/2	6.94	176,35	1.77	45,0	2-1/2	4.55	115,65
1XF77-32-32	2	2	8.58	218,0	2.20	56,0	3-1/8	5.83	148,1

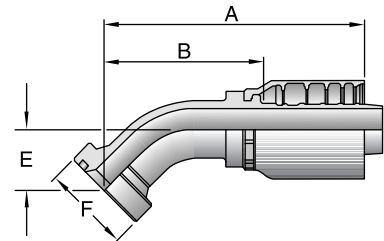

[view on web page](#)



**WARNING:** This product can expose you to chemicals including Lead, which is known to the State of California to cause cancer and birth defects or other reproductive harm. For more information go to [www.p65warnings.ca.gov](http://www.p65warnings.ca.gov).

See Accessories Section for O-Rings and Flange Kits.

**Refer to Pressure Rating of Hose End Connections Chart on page E-47.**

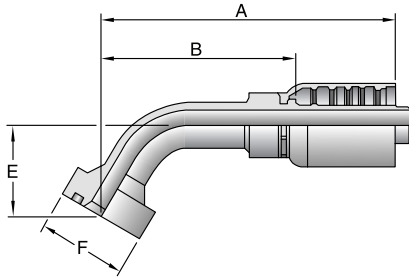
## 1XG77 Caterpillar® Flange Head - 60° Elbow







#			A		E			B	
Part Number	Flange inch	Hose I.D. inch	inch	mm	inch	mm	inch	inch	mm
1XG77-12-12	3/4	3/4	5.35	135,8	1.65	42,0	1-5/8	3.71	94,3
1XG77-16-12	1	3/4	5.35	135,8	1.65	42,0	1-7/8	3.71	94,3
1XG77-16-16	1	1	5.93	150,7	1.97	50,0	1-7/8	3.98	101,2
1XG77-20-16	1-1/4	1	6.07	154,1	1.73	44,0	2-1/8	4.12	104,6
1XG77-20-20	1-1/4	1-1/4	7.31	185,7	2.01	51,0	2-1/8	5.04	128,0
1XG77-24-24	1-1/2	1-1/2	8.18	207,75	2.56	65,0	2-1/2	5.79	147,05
1XG77-32-32	2	2	8.74	222,1	3.27	83,0	3-1/8	5.99	152,1

view on web page

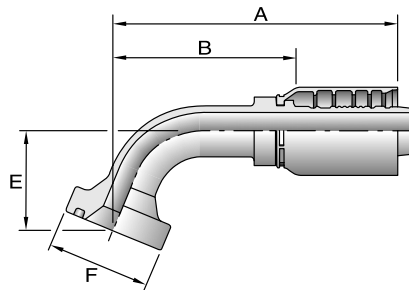
**WARNING:** This product can expose you to chemicals including Lead, which is known to the State of California to cause cancer and birth defects or other reproductive harm. For more information go to [www.p65warnings.ca.gov](http://www.p65warnings.ca.gov).

## 1XM77 Caterpillar® Flange - 67-1/2° Elbow



#			A		E			B	
Part Number	Flange inch	Hose I.D. inch	inch	mm	inch	mm	inch	inch	mm
1XM77-12-12	3/4	3/4	5.17	131,2	1.77	45,0	1-5/8	3.53	89,8
1XM77-16-12	1	3/4	5.19	131,8	1.77	45,0	1-7/8	3.55	90,3
1XM77-16-16	1	1	5.78	146,9	2.05	52,0	1-7/8	3.83	97,4
1XM77-20-16	1-1/4	1	5.78	146,9	2.05	52,0	2-1/8	3.83	97,4
1XM77-32-32	2	2	8.72	221,4	3.82	97,0	3-1/8	5.97	151,5

view on web page

**WARNING:** This product can expose you to chemicals including Lead, which is known to the State of California to cause cancer and birth defects or other reproductive harm. For more information go to [www.p65warnings.ca.gov](http://www.p65warnings.ca.gov).

See Accessories Section for O-Rings and Flange Kits.

**Refer to Pressure Rating of Hose End Connections Chart on page E-47.**

# 1XN77

## Caterpillar® Flange Head - 90° Elbow

# Part Number	Flange inch	Hose I.D. inch	A		E		F inch	B	
			inch	mm	inch	mm		inch	mm
1XN77-12-12	3/4	3/4	4.23	107,4	2.48	63,0	1-5/8	2.59	65,9
1XN77-12-16	3/4	1	4.41	112,0	2.76	70,0	1-5/8	2.46	62,5
1XN77-16-12	1	3/4	4.23	107,4	2.48	63,0	1-7/8	2.59	65,9
1XN77-16-16	1	1	4.65	118,1	2.91	74,0	1-7/8	2.70	68,6
1XN77-24-20	1-1/2	1-1/4	5.35	136,0	3.03	77,0	2-1/2	3.08	78,3
1XN77-24-24	1-1/2	1-1/2	6.24	158,45	4.16	105,6	2-1/2	3.85	97,75
1XN77-32-32	2	2	8.75	222,1	5.24	133,0	3-1/8	5.99	152,2

**WARNING:** This product can expose you to chemicals including Lead, which is known to the State of California to cause cancer and birth defects or other reproductive harm. For more information go to [www.p65warnings.ca.gov](http://www.p65warnings.ca.gov).

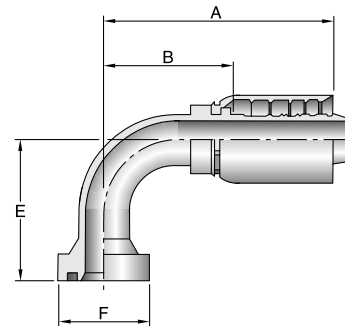

view on web page

# 1K577

## Komatsu® Flange Head

# Part Number	Flange inch	Hose I.D. inch	A		F inch	B	
			inch	mm		inch	mm
1K577-16-16	1	1	4.70	119,4	1-3/4	2.75	69,9

**WARNING:** This product can expose you to chemicals including Lead, which is known to the State of California to cause cancer and birth defects or other reproductive harm. For more information go to [www.p65warnings.ca.gov](http://www.p65warnings.ca.gov).

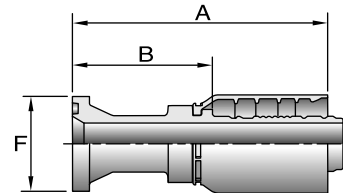

view on web page

# 1KA77

## Komatsu® High Pressure Flange Head

# Part Number	Flange inch	Hose I.D. inch	A		F inch	B	
			inch	mm		inch	mm
1KA77-20-16	1-1/4	1	4.05	102,9	2-1/8	2.10	53,4
1KA77-20-20	1-1/4	1-1/4	5.73	145,6	2-1/8	3.46	87,9
1KA77-24-24	1-1/2	1-1/2	6.39	162,3	2-1/2	4.00	101,6
1KA77-32-32	2	2	7.17	182,0	2-9/16	4.41	112,0

**WARNING:** This product can expose you to chemicals including Lead, which is known to the State of California to cause cancer and birth defects or other reproductive harm. For more information go to [www.p65warnings.ca.gov](http://www.p65warnings.ca.gov).

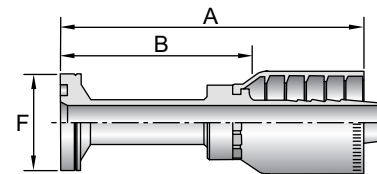

view on web page

See Accessories Section for O-Rings and Flange Kits.

**Refer to Pressure Rating of Hose End Connections Chart on page E-47.**

# 1K677

## Komatsu® Flange Head - 22-1/2° Elbow

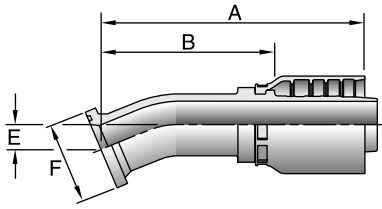

view on web page

# Part Number	Flange inch	Hose I.D. inch	A		E		F		B	
			inch	mm	inch	mm	inch	inch	mm	
1K677-16-20	1	1-1/4	6.48	164,6	0.59	15,0	1-3/4	4.21	106,9	

**WARNING:** This product can expose you to chemicals including Lead, which is known to the State of California to cause cancer and birth defects or other reproductive harm. For more information go to [www.p65warnings.ca.gov](http://www.p65warnings.ca.gov).

# 1K777

## Komatsu® Flange Head - 45° Elbow

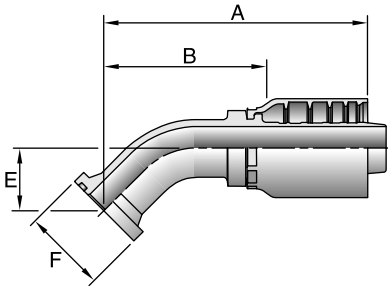

view on web page

# Part Number	Flange inch	Hose I.D. inch	A		E		F		B	
			inch	mm	inch	mm	inch	inch	mm	
1K777-12-12	3/4	3/4	4.57	116,0	1.02	26,0	1-1/2	2.93	74,5	
1K777-16-16	1	1	5.59	142,1	1.26	32,0	1-3/4	3.65	92,6	

**WARNING:** This product can expose you to chemicals including Lead, which is known to the State of California to cause cancer and birth defects or other reproductive harm. For more information go to [www.p65warnings.ca.gov](http://www.p65warnings.ca.gov).

# 1K377

## Komatsu® Flange Head - 60° Elbow

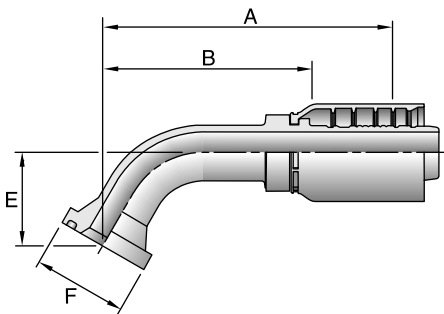

view on web page

# Part Number	Flange inch	Hose I.D. inch	A		E		F		B	
			inch	mm	inch	mm	inch	inch	mm	
1K377-12-12	3/4	3/4	5.27	133,8	1.46	37,0	1-1/2	3.64	92,4	



**WARNING:** This product can expose you to chemicals including Lead, which is known to the State of California to cause cancer and birth defects or other reproductive harm. For more information go to [www.p65warnings.ca.gov](http://www.p65warnings.ca.gov).

See Accessories Section for O-Rings and Flange Kits.

**Refer to Pressure Rating of Hose End Connections Chart on page E-47.**

# 1K877

## Komatsu® Flange Head - 67-1/2° Elbow

#			A		E			B	
Part Number	Flange inch	Hose I.D. inch	inch	mm	inch	mm	inch	inch	mm
1K877-16-16	1	1	5.98	151,9	2.01	51,0	1-3/4	4.03	102,4

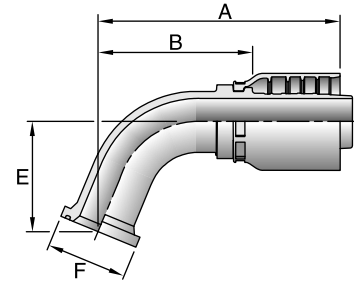

**WARNING:** This product can expose you to chemicals including Lead, which is known to the State of California to cause cancer and birth defects or other reproductive harm. For more information go to [www.p65warnings.ca.gov](http://www.p65warnings.ca.gov).



view on web page

# 1K977

## Komatsu® Flange Head - 90° Elbow

#			A		E			B	
Part Number	Flange inch	Hose I.D. inch	inch	mm	inch	mm	inch	inch	mm
1K977-12-12	3/4	3/4	4.24	107,7	2.28	58,0	1-1/2	2.60	66,0
1K977-16-12	1	3/4	4.24	107,7	2.17	55,0	1-3/4	2.60	66,0
1K977-16-16	1	1	4.65	118,1	2.76	70,0	1-3/4	2.70	68,6

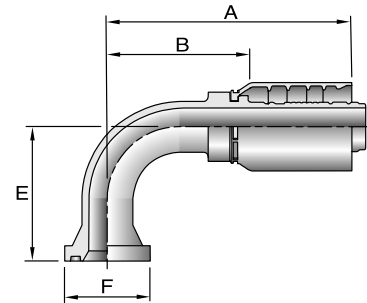

**WARNING:** This product can expose you to chemicals including Lead, which is known to the State of California to cause cancer and birth defects or other reproductive harm. For more information go to [www.p65warnings.ca.gov](http://www.p65warnings.ca.gov).



view on web page

# 1JB77

## Male Seal-Lok® - Bulkhead without Locknut (with O-Ring) End Connection per SAE J516 (Apr2016)

#			A			B	
Part Number	Thread inch	Hose I.D. inch	inch	mm	mm	inch	mm
1JB77-16-16	1-7/16x12	1	4.87	123,7	46	2.92	74,2

Fittings are stocked less locknut (part no. WLNL). Locknuts are manufactured by the Parker Tube Fittings Division and must be ordered separately.

Supplied with Parker's exclusive Trap-Seal™, which leads to improved retention within Seal-Lok's™ ORFS groove and virtually eliminates costly leakage and/or time consuming pre-assembly handling.

**WARNING:** This product can expose you to chemicals including Lead, which is known to the State of California to cause cancer and birth defects or other reproductive harm. For more information go to [www.p65warnings.ca.gov](http://www.p65warnings.ca.gov).

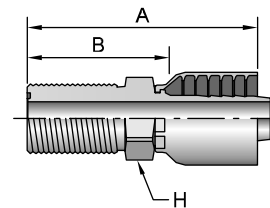

view on web page

See Accessories Section for O-Rings and Flange Kits.

**Refer to Pressure Rating of Hose End Connections Chart on page E-47.**

# 1JC77

## Female Seal-Lok® - Swivel - Short

ISO 12151-1-SWSA

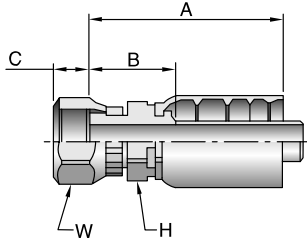

view on web page

# Part Number	Thread		Hose I.D. inch	A		C		Hexagon		B		Additional Material Stainless Steel (C)
	inch			inch	mm	inch	mm	H mm	W mm	inch	mm	
1JC77-8-8	1/2	13/16x16	1/2	2.35	59,8	0.43	11,0	22	24	1.13	28,8	●
1JC77-10-10	5/8	1x14	5/8	2.75	69,8	0.48	12,0	24	30	1.40	35,6	
1JC77-12-8	3/4	1-3/16x12	1/2	2.63	66,9	0.55	14,0	30	36	1.41	35,9	
1JC77-12-12	3/4	1-3/16x12	3/4	3.08	80,2	0.53	12,0	30	36	1.45	38,7	●
1JC77-16-12	1	1-7/16x12	3/4	3.35	85,0	0.53	14,5	30	41	1.71	43,5	
1JC77-16-16	1	1-7/16x12	1	3.59	91,2	0.53	14,5	36	41	1.64	41,7	
1JC77-20-16	1-1/4	1-11/16x12	1	3.53	95,0	0.53	15,0	36	50	1.58	45,5	
1JC77-20-20	1-1/4	1-11/16x12	1-1/4	4.25	108,0	0.53	15,0	46	50	1.98	50,3	
1JC77-24-24	1-1/2	2x12	1-1/2	4.55	115,6	0.53	15,7	50	60	2.16	54,9	
1JC77-32-32*	2	2-1/2x12	2	5.64	143,1	0.73	18,4	65	75	2.88	73,2	●

\*This specific size in stainless is not able to be crimped in any Parkrimp machine.

**WARNING:** This product can expose you to chemicals including Lead, which is known to the State of California to cause cancer and birth defects or other reproductive harm. For more information go to [www.p65warnings.ca.gov](http://www.p65warnings.ca.gov).

# 1JS77

## Female Seal-Lok® - Swivel - Long

ISO 12151-1-SWSB

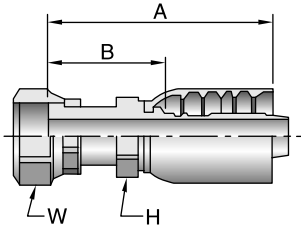

view on web page

# Part Number	Thread		Hose I.D. inch	A		Hexagon		B		Additional Material Stainless Steel (C)
	inch			inch	mm	H mm	W mm	inch	mm	
1JS77-6-8	3/8	11/16x16	1/2	2.67	67,8	22	22	1.45	36,8	
1JS77-8-8	1/2	13/16x16	1/2	2.80	71,2	22	24	1.58	40,2	●
1JS77-10-8	5/8	1x14	1/2	2.95	75,0	24	30	1.73	44,0	
1JS77-10-10	5/8	1x14	5/8	3.21	81,5	24	30	1.86	47,3	
1JS77-10-12	5/8	1x14	3/4	3.58	90,8	30	30	1.94	49,4	
1JS77-12-8	3/4	1-3/16x12	1/2	3.15	80,1	30	36	1.93	49,1	
1JS77-12-10	3/4	1-3/16x12	5/8	3.35	85,1	30	36	2.00	50,8	
1JS77-12-12	3/4	1-3/16x12	3/4	3.68	93,4	30	36	2.04	51,9	
1JS77-12-16	3/4	1-3/16x12	1	4.18	106,2	36	36	2.23	56,7	
1JS77-16-12	1	1-7/16x12	3/4	3.90	99,0	36	41	2.26	57,5	
1JS77-16-16	1	1-7/16x12	1	4.19	106,4	36	41	2.24	56,9	●
1JS77-16-20	1	1-7/16x12	1-1/4	4.71	119,7	46	41	2.44	62,0	
1JS77-20-16	1-1/4	1-11/16x12	1	4.29	108,9	36	50	2.34	59,5	
1JS77-20-20	1-1/4	1-11/16x12	1-1/4	4.78	121,4	46	50	2.51	63,8	●
1JS77-24-24	1-1/2	2x12	1-1/2	5.12	130,0	50	60	2.73	69,4	●
1JS77-32-32	2	2-1/2x12	2	6.28	159,5	65	75	3.52	89,4	

**WARNING:** This product can expose you to chemicals including Lead, which is known to the State of California to cause cancer and birth defects or other reproductive harm. For more information go to [www.p65warnings.ca.gov](http://www.p65warnings.ca.gov).

See Accessories Section for O-Rings and Flange Kits.

**Refer to Pressure Rating of Hose End Connections Chart on page E-47.**

# 1J077

## Male Seal-Lok® - Rigid - (with O-Ring) ISO 12151-1-S

# Part Number	Thread inch	Hose I.D. inch	A		H mm	B	
			inch	mm		inch	mm
1J077-8-8	13/16x16	1/2	2.85	72,3	22	1.39	35,3
1J077-10-8	1x14	1/2	3.03	77,0	27	1.57	39,9
1J077-10-10	1x14	5/8	3.30	83,8	27	1.63	41,4
1J077-12-10	1-3/16x12	5/8	3.44	87,3	32	1.77	45,0
1J077-12-12	1-3/16x12	3/4	3.75	95,3	32	1.84	46,7
1J077-16-12	1-7/16x12	3/4	3.93	99,8	41	2.02	51,3
1J077-16-16	1-7/16x12	1	4.33	110,0	41	2.10	53,3
1J077-20-16	1-11/16x12	1	4.41	112,0	46	2.18	55,4
1J077-20-20	1-11/16x12	1-1/4	4.98	126,5	46	2.27	57,7
1J077-24-20	2x12	1-1/4	5.14	130,5	55	2.43	61,7

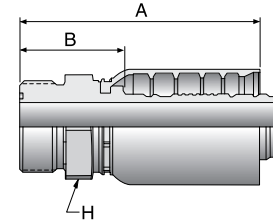

view on web page

Supplied with Parker's exclusive Trap-Seal™, which leads to improved retention within Seal-Lok's™ ORFS groove and virtually eliminates costly leakage and/or time consuming pre-assembly handling.

**⚠ WARNING:** This product can expose you to chemicals including Lead, which is known to the State of California to cause cancer and birth defects or other reproductive harm. For more information go to [www.p65warnings.ca.gov](http://www.p65warnings.ca.gov).

# 1J777

## Female Seal-Lok® - Swivel - 45° Elbow ISO 12151-1-SWE45

# Part Number	Thread inch		Hose I.D. inch	A		E		W mm	B	
	inch	mm		inch	mm	inch	mm		inch	mm
1J777-8-8	1/2	13/16x16	1/2	2.86	72,7	0.59	15	24	1.64	41,8
1J777-10-8	5/8	1x14	1/2	2.97	75,5	0.63	16	30	1.75	44,6
1J777-10-10	5/8	1x14	5/8	3.40	86,0	0.63	16	30	2.05	52,0
1J777-12-12	3/4	1-3/16x12	3/4	4.39	111,4	0.83	21	36	2.75	70,0
1J777-20-16	1-1/4	1-11/16x12	1	4.80	121,8	0.98	25	50	2.85	72,3
1J777-20-20	1-1/4	1-11/16x12	1-1/4	5.64	143,2	0.98	25	50	3.36	85,5
1J777-24-24	1-1/2	2x12	1-1/2	6.82	173,35	1.65	42	60	4.44	112,65

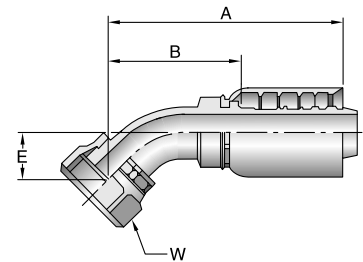

view on web page

**⚠ WARNING:** This product can expose you to chemicals including Lead, which is known to the State of California to cause cancer and birth defects or other reproductive harm. For more information go to [www.p65warnings.ca.gov](http://www.p65warnings.ca.gov).

See Accessories Section for O-Rings and Flange Kits.

**⚠ Refer to Pressure Rating of Hose End Connections Chart on page E-47.**

# 1J977

## Female Seal-Lok® - Swivel - 90° Elbow - Short Drop ISO 12151-1-SWES90

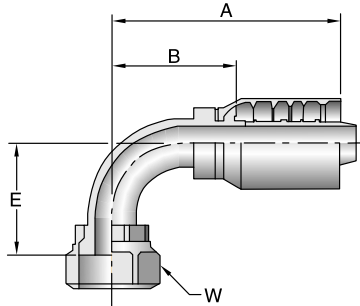

view on web page

# Part Number	Thread		Hose I.D. inch	A		E		W		B	
	inch	mm		inch	mm	inch	mm	inch	mm	inch	mm
1J977-8-8	1/2	13/16x16	1/2	2.78	70,7	1.14	29	24	1.56	39,7	
1J977-10-8	5/8	1x14	1/2	2.77	70,5	1.26	32	30	1.55	39,5	
1J977-10-10	5/8	1x14	5/8	3.21	81,5	1.26	32	30	1.86	47,3	
1J977-12-8	3/4	1-3/16x12	1/2	2.77	70,5	1.89	48	36	1.55	39,5	
1J977-12-10	3/4	1-3/16x12	5/8	3.21	81,5	1.89	48	36	1.86	47,3	
1J977-12-12	3/4	1-3/16x12	3/4	4.24	107,6	1.89	48	36	2.60	66,1	
1J977-16-12	1	1-7/16x12	3/4	4.23	107,4	2.20	56	41	2.59	65,9	
1J977-16-16	1	1-7/16x12	1	4.65	118,1	2.20	56	41	2.70	68,6	
1J977-16-20	1	1-7/16x12	1-1/4	5.05	128,3	2.20	56	41	2.78	70,6	
1J977-20-16	1-1/4	1-11/16x12	1	4.65	118,1	2.52	64	50	2.70	68,6	
1J977-20-20	1-1/4	1-11/16x12	1-1/4	5.35	136,0	2.52	64	50	3.08	78,3	

**WARNING:** This product can expose you to chemicals including Lead, which is known to the State of California to cause cancer and birth defects or other reproductive harm. For more information go to [www.p65warnings.ca.gov](http://www.p65warnings.ca.gov).

# 1J577

## Female Seal-Lok® - Swivel - 90° Elbow - Medium Drop ISO 12151-1 - SWEM90

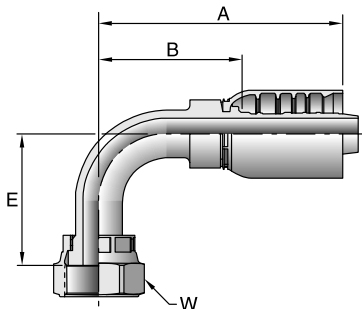

view on web page

# Part Number	Thread		Hose I.D. inch	A		E		W		B		Additional Material Stainless Steel (C)
	inch	mm		inch	mm	inch	mm	inch	mm	inch	mm	
1J577-8-8	1/2	13/16x16	1/2	2.77	70,5	1.61	41	24	1.55	39,5		
1J577-10-10	5/8	1x14	5/8	4.11	104,4	1.85	57	30	2.76	70,1		
1J577-12-12	3/4	1-3/16x12	3/4	4.24	107,6	2.28	58	36	2.60	66,1		
1J577-16-12	1	1-7/16x12	3/4	4.23	107,5	2.80	71	41	2.60	66,0		
1J577-16-16	1	1-7/16x12	1	4.65	118,1	2.80	71	41	2.70	68,6		
1J577-20-20	1-1/4	1-11/16x12	1-1/4	5.35	136,0	3.07	78	50	3.08	78,3		
1J577-20-20C	1-1/4	1-11/16x12	1-1/4	6.20	157,5	3.07	78	50	3.93	99,8	•	
1J577-24-24	1-1/2	2x12	1-1/2	6.24	158,45	3.39	86	60	3.85	97,75	•	

**WARNING:** This product can expose you to chemicals including Lead, which is known to the State of California to cause cancer and birth defects or other reproductive harm. For more information go to [www.p65warnings.ca.gov](http://www.p65warnings.ca.gov).

See Accessories Section for O-Rings and Flange Kits.

**Refer to Pressure Rating of Hose End Connections Chart on page E-47.**



# 1J177

## Female Seal-Lok® - Swivel - 90° Elbow - Long Drop

ISO 12151-1-SWEL90

# Part Number	Thread inch	Hose I.D. inch	A		E		W mm	B		Additional Material Stainless Steel (C)
			inch	mm	inch	mm		inch	mm	
1J177-8-8	13/16x16	1/2	2.77	70,5	2.52	64	24	1.55	39,5	
1J177-10-10	1x14	5/8	3.21	81,5	2.76	70	30	1.86	47,3	
1J177-12-10	1-3/16x12	5/8	3.21	81,5	3.78	96	36	1.86	47,3	
1J177-12-12	1-3/16x12	3/4	4.23	107,4	3.78	96	36	2.59	65,9	
1J177-16-12	1-7/16x12	3/4	4.23	107,4	4.49	114	41	2.59	65,9	
1J177-16-16	1-7/16x12	1	4.65	118,1	4.49	114	41	2.70	68,6	
1J177-20-16	1-11/16x12	1	4.65	118,1	5.08	129	50	2.70	68,6	
1J177-20-20	1-11/16x12	1-1/4	5.35	136,0	5.08	129	50	3.08	78,3	
1J177-20-20C	1-11/16x12	1-1/4	6.29	159,8	5.08	129	50	4.02	102,1	●

**WARNING:** This product can expose you to chemicals including Lead, which is known to the State of California to cause cancer and birth defects or other reproductive harm. For more information go to [www.p65warnings.ca.gov](http://www.p65warnings.ca.gov).

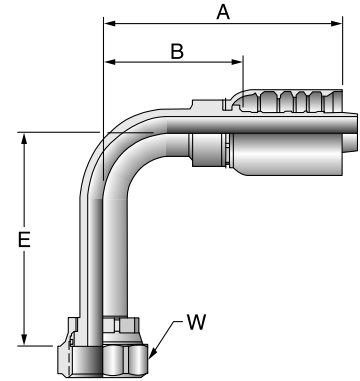

view on web page

# 1D277

## Male Metric S - Rigid - (24° Cone)

End Connection per ISO 8434-1-BHS

# Part Number	Thread mm	Hose I.D. inch	A		H mm	B	
			inch	mm		inch	mm
1D277-16-8	M24x1,5	1/2	2.53	64,4	24	1.31	33,4
1D277-20-10	M30x2	5/8	2.85	72,4	30	1.50	38,1
1D277-20-12	M30x2	3/4	3.29	83,6	30	1.66	42,1
1D277-25-12	M36x2	3/4	3.39	86,3	36	1.76	44,8
1D277-30-16	M42x2	1	3.91	99,3	46	1.96	49,8
1D277-38-20	M52x2	1-1/4	4.50	114,3	55	2.23	56,6

**WARNING:** This product can expose you to chemicals including Lead, which is known to the State of California to cause cancer and birth defects or other reproductive harm. For more information go to [www.p65warnings.ca.gov](http://www.p65warnings.ca.gov).

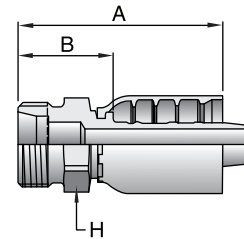

view on web page

See Accessories Section for O-Rings and Flange Kits.

**Refer to Pressure Rating of Hose End Connections Chart on page E-47.**

# 1C977

## Female Metric S - Swivel - (24° Cone with O-Ring) ISO 12151-2-SWS

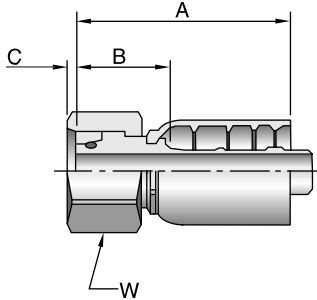

view on web page

# Part Number	Thread mm	Hose I.D. inch	A inch mm		C inch mm		W mm	B inch mm		Additional Material Stainless Steel (C)
1C977-12-8	12 M20x1,5	1/2	2.39	60,8	0.03	1,0	24	1.17	29,8	•
1C977-16-8	16 M24x1,5	1/2	2.34	59,5	0.09	2,0	30	1.12	28,5	•
1C977-16-10	16 M24x1,5	5/8	2.64	67,0	0.09	2,0	30	1.29	32,8	•
1C977-20-8	20 M30x2	1/2	2.46	62,5	0.05	1,3	36	1.24	31,5	•
1C977-20-10	20 M30x2	5/8	2.64	67,0	0.05	1,3	36	1.29	32,8	•
1C977-20-12	20 M30x2	3/4	2.97	75,5	0.05	1,3	36	1.34	34,0	•
1C977-25-12	25 M36x2	3/4	3.00	76,5	0.10	2,6	46	1.37	35,0	•
1C977-25-16	25 M36x2	1	3.60	91,4	0.10	2,6	46	1.65	41,9	•
1C977-30-12	30 M42x2	3/4	3.17	80,4	0.19	5,0	50	1.53	39,0	•
1C977-30-16	30 M42x2	1	3.50	89,0	0.19	5,0	50	1.55	39,5	•
1C977-30-20	30 M42x2	1-1/4	4.09	103,9	0.19	5,0	50	1.82	46,2	•
1C977-38-20	38 M52x2	1-1/4	3.92	99,6	0.27	6,9	60	1.65	42,0	•
1C977-38-24	38 M52x2	1-1/2	4.08	103,7	0.24	6,0	60	1.69	43,1	•

When measuring overall length to end of nut, B + C dimensions must be used to calculate cut-off allowance.

**WARNING:** This product can expose you to chemicals including Lead, which is known to the State of California to cause cancer and birth defects or other reproductive harm. For more information go to [www.p65warnings.ca.gov](http://www.p65warnings.ca.gov).

# 10C77

## Female Metric S - Swivel - 45° Elbow - (24° Cone with O-Ring) ISO 12151-2-SWE-45

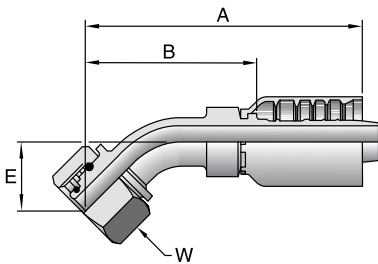

view on web page

# Part Number	Thread mm	Hose I.D. inch	A inch mm		E inch mm		W mm	B inch mm	
10C77-16-8	16 M24x1,5	1/2	3.28	83,4	0.93	23,5	30	2.06	52,4
10C77-20-10	20 M30x2	5/8	4.20	106,7	1.10	28,0	36	2.85	72,4
10C77-20-12	20 M30x2	3/4	4.74	120,4	1.18	30,0	36	3.10	78,8
10C77-25-12	25 M36x2	3/4	4.70	119,3	1.14	29,0	46	3.06	77,8
10C77-25-16	25 M36x2	1	5.59	141,9	1.30	33,0	46	3.64	92,4
10C77-30-16	30 M42x2	1	5.58	141,8	1.30	33,0	50	3.63	92,3
10C77-38-20	38 M52x2	1-1/4	6.60	167,7	1.44	36,5	60	4.33	110,0
10C77-38-24	38 M52x2	1-1/2	7.09	180,05	1.93	49,0	60	4.70	119,35

**WARNING:** This product can expose you to chemicals including Lead, which is known to the State of California to cause cancer and birth defects or other reproductive harm. For more information go to [www.p65warnings.ca.gov](http://www.p65warnings.ca.gov).

See Accessories Section for O-Rings and Flange Kits.

**Refer to Pressure Rating of Hose End Connections Chart on page E-47.**

# 11C77

**Female Metric S - Swivel - 90° Elbow - (24° Cone with O-Ring)**  
ISO 12151-2-SWE

# Part Number	Thread mm	Hose I.D. inch	A		E		W mm	B	
			inch	mm	inch	mm		inch	mm
11C77-16-8	M24x1,5	1/2	3.02	76,6	1.77	45	30	1.80	45,6
11C77-20-10	M30x2	5/8	3.62	92,0	2.09	53	36	2.27	57,8
11C77-20-12	M30x2	3/4	4.25	107,9	2.36	60	36	2.61	66,4
11C77-25-12	M36x2	3/4	4.25	107,9	2.32	59	46	2.61	66,4
11C77-25-16	M36x2	1	4.65	118,1	2.75	70	46	2.70	68,6
11C77-30-16	M42x2	1	5.16	131,0	2.72	69	50	3.21	81,6
11C77-38-20	M52x2	1-1/4	6.28	159,5	3.07	78	60	4.01	101,8
11C77-38-24	M52x2	1-1/2	6.24	158,45	3.98	101	60	3.85	97,75

**WARNING:** This product can expose you to chemicals including Lead, which is known to the State of California to cause cancer and birth defects or other reproductive harm. For more information go to [www.p65warnings.ca.gov](http://www.p65warnings.ca.gov).

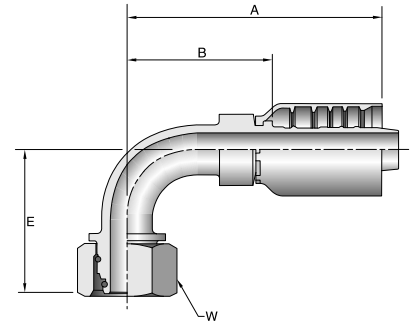

[view on web page](#)

# 1FU77

**Female BSP Parallel Pipe - Swivel - (30° Flare)**  
B8363 Code F

# Part Number	Thread inch	Hose I.D. inch	A		H mm	W mm	B	
			inch	mm			inch	mm
1FU77-8-8	1/2x14	1/2	2.89	73,4	22	27	1.67	42,4
1FU77-12-12	3/4x14	3/4	3.71	94,1	32	36	2.07	52,6
1FU77-16-16	1x11	1	4.31	109,5	41	41	2.36	60,0
1FU77-20-20	1-1/4x11	1-1/4	4.88	123,9	50	50	2.60	66,1
1FU77-24-24	1-1/2x11	1-1/2	5.42	137,7	60	60	3.03	77,1

**WARNING:** This product can expose you to chemicals including Lead, which is known to the State of California to cause cancer and birth defects or other reproductive harm. For more information go to [www.p65warnings.ca.gov](http://www.p65warnings.ca.gov).

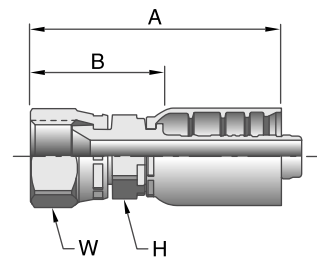

[view on web page](#)

See Accessories Section for O-Rings and Flange Kits.

**Refer to Pressure Rating of Hose End Connections Chart on page E-47.**

### 1KU77 Female Metric - Swivel - (30° Flare)

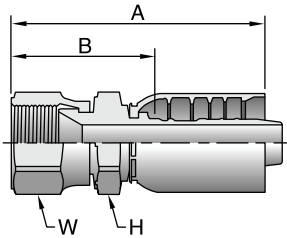

view on web page

# Part Number	Thread mm	Hose I.D. inch	A		H	W	B	
			inch	mm	mm	mm	inch	mm
1KU77-10-10	M24x1,5	5/8	3.44	87,5	32	32	2.09	53,2
1KU77-12-12	M30x1,5	3/4	3.79	96,3	36	36	2.16	54,8
1KU77-16-16	M33x1,5	1	4.61	117,1	41	41	2.66	67,6

**WARNING:** This product can expose you to chemicals including Lead, which is known to the State of California to cause cancer and birth defects or other reproductive harm. For more information go to [www.p65warnings.ca.gov](http://www.p65warnings.ca.gov).

### 1MU77 Female Metric - Swivel - (30° Flare)

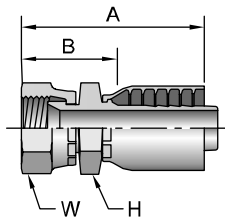

view on web page

# Part Number	Thread mm	Hose I.D. inch	A		H	W	B	
			inch	mm	mm	mm	inch	mm
1MU77-8-8	M22x1,5	1/2	2.89	73,4	22	27	1.67	42,4

**WARNING:** This product can expose you to chemicals including Lead, which is known to the State of California to cause cancer and birth defects or other reproductive harm. For more information go to [www.p65warnings.ca.gov](http://www.p65warnings.ca.gov).

### 1XU77 Female Metric - Swivel - (30° Flare)

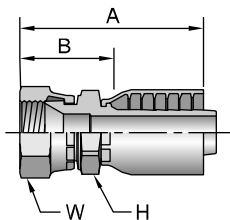

view on web page

# Part Number	Thread mm	Hose I.D. inch	A		H	W	B	
			inch	mm	mm	mm	inch	mm
1XU77-10-10	M24x1,5	5/8	3.44	87,5	30	32	2.09	53,2
1XU77-12-12	M30x1,5	3/4	3.93	99,7	32	36	2.29	58,3
1XU77-16-16	M33x1,5	1	4.55	115,6	36	41	2.60	66,1
1XU77-20-20	M36x1,5	1-1/4	5.18	131,4	46	46	2.90	73,7
1XU77-24-24	M42x1,5	1-1/2	5.65	143,4	50	55	3.26	82,7

**WARNING:** This product can expose you to chemicals including Lead, which is known to the State of California to cause cancer and birth defects or other reproductive harm. For more information go to [www.p65warnings.ca.gov](http://www.p65warnings.ca.gov).

See Accessories Section for O-Rings and Flange Kits.

**Refer to Pressure Rating of Hose End Connections Chart on page E-47.**

# 1D977

## Male BSP Parallel Pipe - Rigid - (60° Cone)

# Part Number	Thread inch	Hose I.D. inch	A		H mm	B	
			inch	mm		inch	mm
1D977-12-12	3/4x14A	3/4	3.43	87,0	32	1.79	45,6

**⚠️ WARNING:** This product can expose you to chemicals including Lead, which is known to the State of California to cause cancer and birth defects or other reproductive harm. For more information go to [www.p65warnings.ca.gov](http://www.p65warnings.ca.gov).

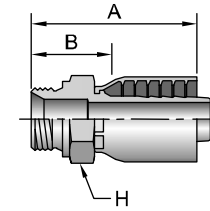

view on web page

# 19277

## Female BSP Parallel Pipe - Swivel - (60° Cone)

# Part Number	Thread inch	Hose I.D. inch	A		C		W mm	B	
			inch	mm	inch	mm		inch	mm
19277-12-12	3/4x12	3/4	2.86	72,6	0.35	8,9	32	1.22	31,1
19277-24-24	1-1/2x11	1-1/2	4.07	103,4	0.45	11,5	55	1.68	42,7
19277-32-32	2x11	2	4.93	125,1	0.50	13,3	70	2.17	55,1

**⚠️ WARNING:** This product can expose you to chemicals including Lead, which is known to the State of California to cause cancer and birth defects or other reproductive harm. For more information go to [www.p65warnings.ca.gov](http://www.p65warnings.ca.gov).

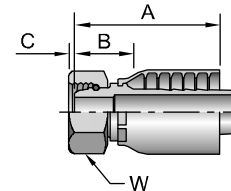

view on web page

# 1EA77

## Female BSP Parallel Pipe - Swivel - (60° Cone with O-Ring)

# Part Number	Thread inch	Hose I.D. inch	A		W mm	B	
			inch	mm		inch	mm
1EA77-24-24	1-1/2x11	1-1/2	4.05	102,9	55	1.66	42,2
1EA77-32-32	2x11	2	4.63	117,7	70	1.88	47,8

**⚠️ WARNING:** This product can expose you to chemicals including Lead, which is known to the State of California to cause cancer and birth defects or other reproductive harm. For more information go to [www.p65warnings.ca.gov](http://www.p65warnings.ca.gov).

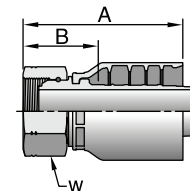

view on web page

See Accessories Section for O-Rings and Flange Kits.

**⚠️ Refer to Pressure Rating of Hose End Connections Chart on page E-47.**

# 1GU77

## Female BSP Parallel Pipe - Swivel - (60° Cone)

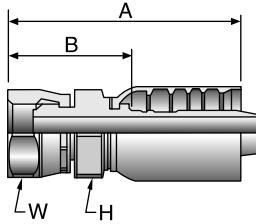

[view on web page](#)

# Part Number	Thread inch	Hose I.D. inch	A		H		W		B	
			inch	mm	mm	mm	inch	mm		
1GU77-8-8	1/2x14	1/2	2.97	75,5	27	27	1.75	44,5		
1GU77-12-12	3/4x14	3/4	3.74	94,9	36	36	2.10	53,4		
1GU77-16-16	1x11	1	4.33	110,0	41	41	2.38	60,5		
1GU77-20-20	1-1/4x11	1-1/4	4.91	124,7	46	50	2.64	67,0		
1GU77-24-24	1-1/2x11	1-1/2	5.49	139,3	60	60	3.09	78,6		
1GU77-32-32	2x11	2	6.04	153,4	70	70	3.28	83,4		

**WARNING:** This product can expose you to chemicals including Lead, which is known to the State of California to cause cancer and birth defects or other reproductive harm. For more information go to [www.p65warnings.ca.gov](http://www.p65warnings.ca.gov).

# 1B177

## Female BSP Parallel Pipe - Swivel - 45° Elbow (60° Cone)

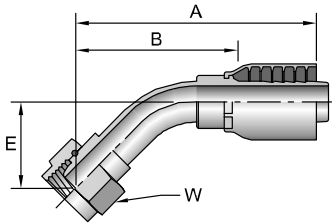

[view on web page](#)

# Part Number	Thread inch	Hose I.D. inch	A		E		W mm	B	
			inch	mm	inch	mm		inch	mm
1B177-16-16	1x11	1	5.71	145,0	1.42	36	41	3.76	95,5

**WARNING:** This product can expose you to chemicals including Lead, which is known to the State of California to cause cancer and birth defects or other reproductive harm. For more information go to [www.p65warnings.ca.gov](http://www.p65warnings.ca.gov).

See Accessories Section for O-Rings and Flange Kits.

**Refer to Pressure Rating of Hose End Connections Chart on page E-47.**

# 1B277

## Female BSP Parallel Pipe - Swivel - 90° Elbow (60° Cone)

# Part Number	Thread inch	Hose I.D. inch	A		E		W mm	B		Additional Material Stainless Steel (C)
			inch	mm	inch	mm		inch	mm	
1B277-12-12	3/4x14	3/4	4.26	108,1	2.17	55,0	32	2.62	66,6	•
1B277-16-16	1x11	1	4.65	118,1	2.89	73,5	41	2.70	68,6	

**WARNING:** This product can expose you to chemicals including Lead, which is known to the State of California to cause cancer and birth defects or other reproductive harm. For more information go to [www.p65warnings.ca.gov](http://www.p65warnings.ca.gov).

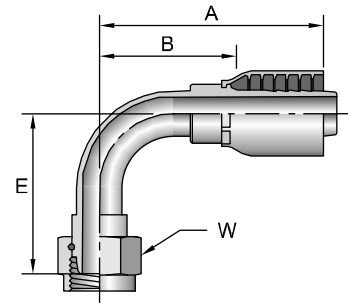

view on web page

# 1CA77

## Female Metric L - Swivel - (24° Cone with O-Ring)

# Part Number	Thread mm	Hose I.D. inch	A		C mm	W mm	B	
			inch	mm			inch	mm
1CA77-22-12	M30x2	3/4	2.86	72,6	0.15	36	1.22	31,1
1CA77-28-16	M36x2	1	3.52	89,4	0.08	41	1.57	39,9
1CA77-35-20	M42x2	1-1/4	3.95	100,4	0.06	50	1.68	42,6
1CA77-42-24	M52x2	1-1/2	4.18	106,2	0.14	60	1.79	45,5

**WARNING:** This product can expose you to chemicals including Lead, which is known to the State of California to cause cancer and birth defects or other reproductive harm. For more information go to [www.p65warnings.ca.gov](http://www.p65warnings.ca.gov).

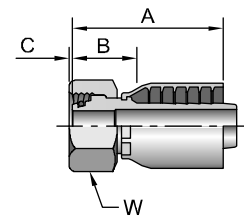

view on web page

# 1ZM77

## Male 24° Cone Metric - Rigid

# Part Number	Thread mm	Hose I.D. inch	A		H mm	B	
			inch	mm		inch	mm
1ZM77-22-10	M30x1,5	5/8	2.83	71,8	36	1.48	37,6
1ZM77-22-12	M30x1,5	3/4	3.17	80,4	36	1.53	39,0
1ZM77-28-12	M36x1,5	3/4	3.38	85,8	41	1.74	44,3
1ZM77-28-16	M36x1,5	1	3.77	95,8	41	1.82	46,2
1ZM77-35-16	M45x1,5	1	3.85	97,8	50	1.90	48,3

**WARNING:** This product can expose you to chemicals including Lead, which is known to the State of California to cause cancer and birth defects or other reproductive harm. For more information go to [www.p65warnings.ca.gov](http://www.p65warnings.ca.gov).

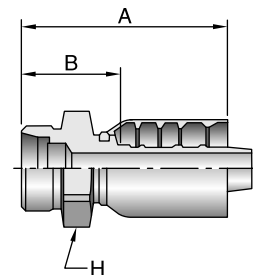

view on web page



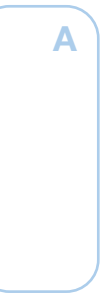

See Accessories Section for O-Rings and Flange Kits.

**Refer to Pressure Rating of Hose End Connections Chart on page E-47.**

*Notes*

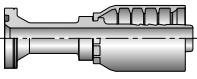
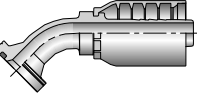
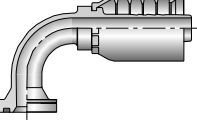

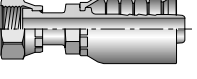
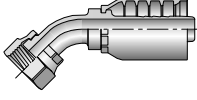
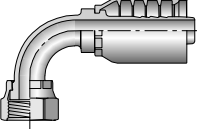

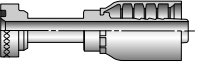
 <p><b>Code 62 Flange</b></p>	<p>16A79 B-126</p>  <p><i>Flange</i></p>	<p>16F79 B-126</p>  <p><i>45° Elbow</i></p>	<p>16N79 B-126</p>  <p><i>90° Elbow</i></p>	 <p><b>Seal-Lok® (O-Ring Face Seal)</b></p>	<p>1JS79 B-127</p>  <p><i>Female - Swivel Long</i></p>
<p>1J779 B-127</p>  <p><i>Female - Swivel 45° Elbow</i></p>	<p>1J979 B-128</p>  <p><i>Female - Swivel 90° Elbow - Short</i></p>	 <p><b>Flange Head</b></p>	<p>1XA79 B-128</p>  <p><i>Flange Head</i></p>		



## 16A79

### SAE Code 62 Flange Head

ISO 12151-3 - S - S

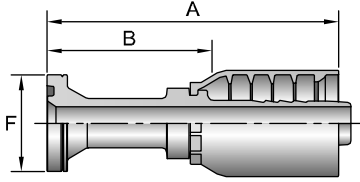

view on web page

# Part Number	Flange inch	Hose I.D. inch	A		F		B	
			inch	mm	inch	mm	inch	mm
16A79-12-12	3/4	3/4	4.90	124	1-5/8	2.84	72	
16A79-16-16	1	1	5.48	139	1-7/8	3.31	84	
16A79-20-16	1-1/4	1	4.28	109	2-1/8	2.11	54	
16A79-20-20	1-1/4	1-1/4	6.09	155	2-1/8	3.41	87	
16A79-24-24	1-1/2	1-1/2	7.11	181	1-1/2	4.07	103	

**WARNING:** This product can expose you to chemicals including Lead, which is known to the State of California to cause cancer and birth defects or other reproductive harm. For more information go to [www.p65warnings.ca.gov](http://www.p65warnings.ca.gov).

## 16F79

### SAE Code 62 Flange Head - 45° Elbow

ISO 12151-3 - E45S - S (1 Piece: ISO 12151-3 - E45M - S)

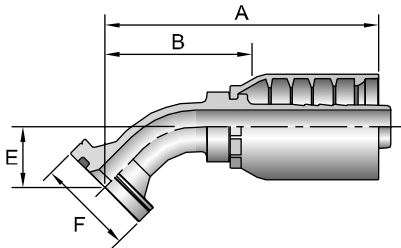

view on web page

# Part Number	Flange inch	Hose I.D. inch	A		E		F		B	
			inch	mm	inch	mm	inch	mm	inch	mm
16F79-16-16	1	1	5.33	135	1.26	32	1-7/8	3.16	80	
16F79-20-20	1-1/4	1-1/4	6.77	172	1.50	38	2-1/8	4.09	104	

**WARNING:** This product can expose you to chemicals including Lead, which is known to the State of California to cause cancer and birth defects or other reproductive harm. For more information go to [www.p65warnings.ca.gov](http://www.p65warnings.ca.gov).

## 16N79

### SAE Code 62 Flange Head - 90° Elbow

ISO 12151-3 - E90S - S (1 Piece: ISO 12151-3 - E90M - S)

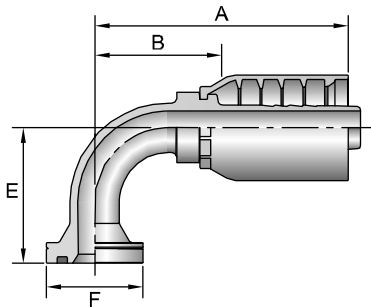

view on web page

# Part Number	Flange inch	Hose I.D. inch	A		E		F		B	
			inch	mm	inch	mm	inch	mm	inch	mm
16N79-12-12	3/4	3/4	4.27	108	2.28	58	1-5/8	2.21	56	
16N79-16-12	1	3/4	4.27	108	2.28	58	1-7/8	2.21	56	
16N79-16-16	1	1	4.95	126	2.76	70	1-7/8	2.78	71	
16N79-20-16	1-1/4	1	4.95	126	2.76	70	2-1/8	2.78	71	
16N79-20-20	1-1/4	1-1/4	6.31	160	3.54	90	2-1/8	3.63	92	
16N79-24-24	1-1/2	1-1/2	7.50	190	4.09	104	2-1/2	4.46	113	

**WARNING:** This product can expose you to chemicals including Lead, which is known to the State of California to cause cancer and birth defects or other reproductive harm. For more information go to [www.p65warnings.ca.gov](http://www.p65warnings.ca.gov).

See Accessories Section for O-Rings and Flange Kits.

# 1JS79

## Female Seal-Lok® - Swivel - Long

ISO 12151-1 - SWSB

# Part Number	Thread		Hose I.D. inch	A		H inch	W inch	B	
	inch	inch		inch	mm			inch	mm
1JS79-12-12	3/4	1-3/16x12	3/4	3.99	101	1-1/8	1-3/8	1.93	49
1JS79-16-12	1	1-7/16x12	3/4	4.26	108	1-3/8	1-5/8	2.20	56
1JS79-16-16	1	1-7/16x12	1	4.45	113	1-3/8	1-5/8	2.28	58
1JS79-20-16	1-1/4	1-11/16x12	1	4.32	110	1-3/4	1-7/8	2.15	55
1JS79-20-20	1-1/4	1-11/16x12	1-1/4	5.00	127	1-3/4	1-7/8	2.32	59
1JS79-24-24	1-1/2	2x12	1-1/2	5.28	134	2	2-1/4	2.24	57

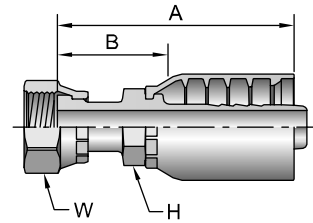

view on web page

**WARNING:** This product can expose you to chemicals including Lead, which is known to the State of California to cause cancer and birth defects or other reproductive harm. For more information go to [www.p65warnings.ca.gov](http://www.p65warnings.ca.gov).

# 1J779

## Female Seal-Lok® - Swivel - 45° Elbow

ISO 12151-1 - SWE45

# Part Number	Thread		Hose I.D. inch	A		E		W inch	B	
	inch	inch		inch	mm	inch	mm		inch	mm
1J779-12-12	3/4	1-3/16x12	3/4	4.40	112	0.83	21	1-3/8	2.34	59
1J779-16-16	1	1-7/16x12	1	5.01	127	0.94	24	1-5/8	2.84	72
1J779-20-20	1-1/4	1-11/16x12	1-1/4	6.15	156	1.00	25	1-7/8	3.49	89

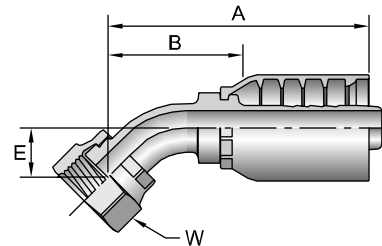

view on web page

See Accessories Section for O-Rings and Flange Kits.

**WARNING:** This product can expose you to chemicals including Lead, which is known to the State of California to cause cancer and birth defects or other reproductive harm. For more information go to [www.p65warnings.ca.gov](http://www.p65warnings.ca.gov).

**!** Refer to Pressure Rating of Hose End Connections Chart on page E-47.

### 1J979

#### Female Seal-Lok® - Swivel - 90° Elbow - Short Drop

ISO - 12151-1 - SWES90

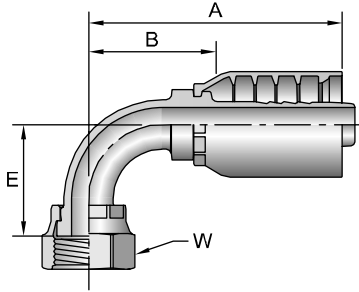

view on web page

# Part Number	Thread		Hose I.D. inch	A		E		W inch	B	
	inch	inch		inch	mm	inch	mm		inch	mm
1J979-12-12	3/4	1-3/16x12	3/4	4.27	108	1.88	48	1-3/8	2.21	56
1J979-16-16	1	1-7/16x12	1	4.95	126	2.21	56	1-5/8	2.78	71

**WARNING:** This product can expose you to chemicals including Lead, which is known to the State of California to cause cancer and birth defects or other reproductive harm. For more information go to [www.p65warnings.ca.gov](http://www.p65warnings.ca.gov).

### 1XA79

#### Caterpillar® Flange Head

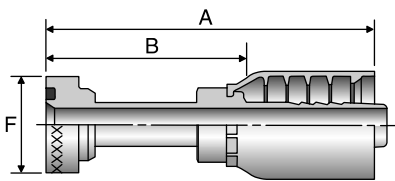

view on web page









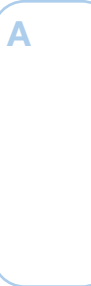

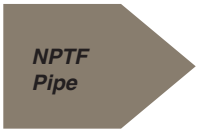
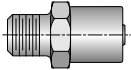
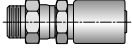
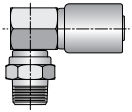

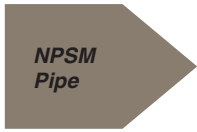
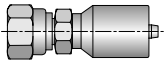

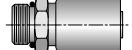

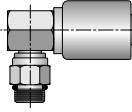

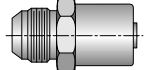
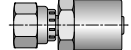
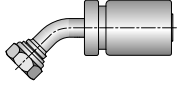
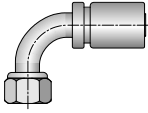
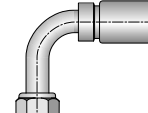

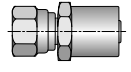
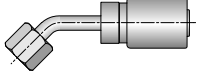
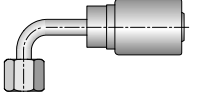

# Part Number	Flange inch	Hose I.D. inch	A		F inch	B	
			inch	mm		inch	mm
1XA79-16-16	1	1	5.75	146	1-7/8	3.59	91

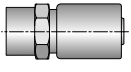
**WARNING:** This product can expose you to chemicals including Lead, which is known to the State of California to cause cancer and birth defects or other reproductive harm. For more information go to [www.p65warnings.ca.gov](http://www.p65warnings.ca.gov).

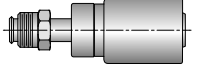
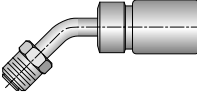
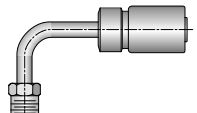
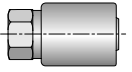
**Refer to Pressure Rating of Hose End Connections Chart on page E-47.**

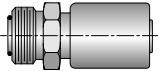
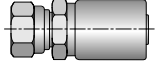
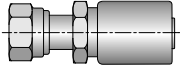
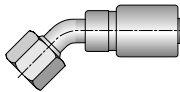
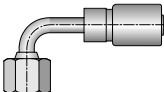
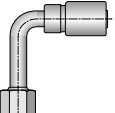
*Notes*

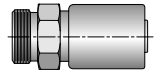
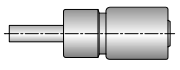

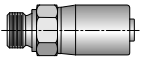
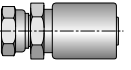
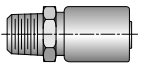
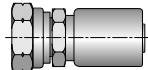
A		101HY B-131  Male - Rigid	113HY B-131  Male - Swivel	11LHY B-132  Male - Swivel 90° Elbow	102HY B-132  Female - Rigid	
	107HY B-132  Female - Swivel (60° Cone)		105HY B-133  Male - Rigid	10GHY B-133  Male - Swivel	10LHY B-134  Male - Swivel 90° Elbow	
B	103HY B-134  Male - Rigid	106HY B-135  Female - Swivel	137HY B-136  Female - Swivel 45° Elbow - Short	139HY B-136  Female - Swivel 90° Elbow - Short	141HY B-137  Female - Swivel 90° Elbow - Long	
	108HY B-137  Female - Swivel	177HY B-138  Female - Swivel 45° Elbow	179HY B-138  Female - Swivel 90° Elbow		111HY B-138  Male - Rigid	
C	1GJHY B-139  Female - Rigid		128HY B-139  Male - Swivel	167HY B-139  Male - Swivel 45° Elbow	169HY B-140  Male - Swivel 90° Elbow	129HY B-140  Female - Rigid
		1J0HY B-140  Male - Rigid w/O-Ring	1JCHY B-140  Female - Swivel Short	1JSHY B-141  Female - Swivel Long	1J7HY B-141  Female - Swivel 45° Elbow	1J9HY B-142  Female - Swivel 90° Elbow - Short
D	1J1HY B-142  Female - Swivel 90° Elbow - Long		1D0HY B-143  Male - Rigid	13DHY B-143  Male Standpipe Rigid		1D9HY B-143  Male - Rigid
	1GUHY B-144  Female - Swivel	1UTHY B-144  Male - Rigid	1XUHY B-144  Female - Metric Swivel			
E						

# 101HY

## Male NPTF Pipe - Rigid

# Part Number	Thread	Hose I.D.	A		H	B		Additional Material Stainless Steel (C)
			inch	mm		inch	mm	
101HY-2-4	1/8x27	1/4	2.34	59	5/8	1.00	25	
101HY-4-4	1/4x18	1/4	2.53	64	9/16	1.19	30	•
101HY-4-5	1/4x18	5/16	2.56	65	11/16	1.22	31	
101HY-4-6	1/4x18	3/8	2.55	65	11/16	1.19	30	
101HY-6-4	3/8x18	1/4	2.53	64	3/4	1.19	30	
101HY-6-5	3/8x18	5/16	2.56	65	3/4	1.22	31	
101HY-6-6	3/8x18	3/8	2.55	65	3/4	1.19	30	•
101HY-6-8	3/8x18	1/2	2.72	69	7/8	1.38	35	
101HY-8-4	1/2x14	1/4	2.72	69	7/8	1.38	35	
101HY-8-6	1/2x14	3/8	2.73	69	7/8	1.38	35	
101HY-8-8	1/2x14	1/2	2.91	74	7/8	1.41	40	•
101HY-8-10	1/2x14	5/8	2.94	75	1-1/8	1.59	40	
101HY-8-12	1/2x14	3/4	3.08	78	1-1/4	1.50	38	
101HY-12-8	3/4x14	1/2	2.91	74	1-1/16	1.56	40	
101HY-12-12	3/4x14	3/4	3.08	78	1-1/4	1.50	38	•
101HY-12-16	3/4x14	1	3.23	82	1-3/8	1.63	41	
101HY-16-12	1x11-1/2	3/4	3.27	83	1-3/8	1.69	43	
101HY-16-14	1x11-1/2	7/8	3.27	83	1-3/8	1.78	43	
101HY-16-16	1x11-1/2	1	3.42	87	1-3/8	1.81	46	•
101HY-20-20	1-1/4x11-1/2	1-1/4	3.84	98	1-3/4	2.00	51	

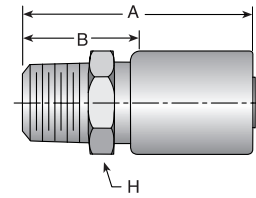

view on web page

Stainless steel fittings must be assembled with Karrykrimp 2, Phastkrimp, Superkrimp or Parkrimp 2. See CrimpSource for more information.

**WARNING:** This product can expose you to chemicals including Lead, which is known to the State of California to cause cancer and birth defects or other reproductive harm. For more information go to [www.p65warnings.ca.gov](http://www.p65warnings.ca.gov).

# 113HY

## Male NPTF Pipe - Swivel

# Part Number	Thread	Hose I.D.	A		H	W	B	
			inch	mm			inch	mm
113HY-2-4	1/8x27	1/4	2.97	75	9/16	5/8	1.63	41
113HY-4-4	1/4x18	1/4	3.06	78	9/16	5/8	1.72	44
113HY-4-6	1/4x18	3/8	3.17	81	11/16	11/16	1.81	46
113HY-6-4	3/8x18	1/4	3.13	80	5/8	11/16	1.78	45
113HY-6-6	3/8x18	3/8	3.11	79	11/16	11/16	1.75	44
113HY-6-8	3/8x18	1/2	3.31	84	7/8	7/8	1.97	50
113HY-8-6	1/2x14	3/8	3.38	86	7/8	7/8	2.03	52
113HY-8-8	1/2x14	1/2	3.50	89	7/8	7/8	2.16	55
113HY-12-12	3/4x14	3/4	3.95	100	1-1/4	1-1/4	2.38	60
113HY-16-16	1x11-1/2	1	4.23	107	1-1/2	1-1/2	2.63	67

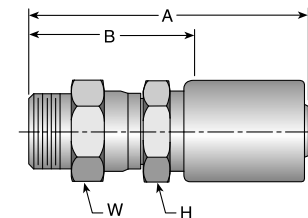

view on web page

Fitting allows minor movement under pressure to relieve stress on hose but is not to be used for continuous swiveling.

See Technical Section for Pressure Limitations.

**WARNING:** This product can expose you to chemicals including Lead, which is known to the State of California to cause cancer and birth defects or other reproductive harm. For more information go to [www.p65warnings.ca.gov](http://www.p65warnings.ca.gov).

# 11LHY

## Male NPTF Pipe - Swivel - 90° Elbow

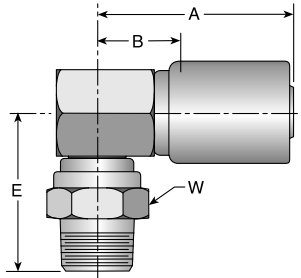

view on web page

# Part Number	Thread inch	Hose I.D. inch	A		E		W		B	
			inch	mm	inch	mm	inch	inch	mm	
11LHY-2-4	1/8x27	1/4	2.31	59	1.50	38	5/8	0.97	25	
11LHY-4-4	1/4x18	1/4	2.31	59	1.69	43	11/16	0.97	25	
11LHY-6-6	3/8x8	3/8	2.33	59	1.63	41	11/16	0.97	25	
11LHY-8-6	1/2x14	3/8	2.73	69	1.88	48	7/8	0.97	25	
11LHY-8-8	1/2x14	1/2	3.00	76	1.93	49	7/8	1.09	28	

**WARNING:** This product can expose you to chemicals including Lead, which is known to the State of California to cause cancer and birth defects or other reproductive harm. For more information go to [www.p65warnings.ca.gov](http://www.p65warnings.ca.gov).

# 102HY

## Female NPTF Pipe - Rigid

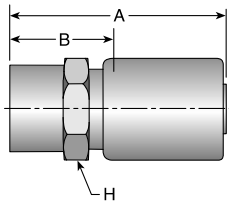

view on web page

# Part Number	Thread inch	Hose I.D. inch	A		H	B	
			inch	mm	inch	inch	mm
102HY-2-4	1/8x27	1/4	2.34	59	5/8	1.00	25
102HY-4-4	1/4x18	1/4	2.47	63	11/16	1.13	29
102HY-4-6	1/4x18	3/8	2.48	63	11/16	1.13	29
102HY-6-6	3/8x18	3/8	2.48	63	7/8	1.13	29
102HY-8-6	1/2x14	3/8	2.75	70	1	1.41	36
102HY-8-8	1/2x14	1/2	2.84	72	1	1.50	38
102HY-12-12	3/4x14	3/4	2.83	72	1-1/4	1.25	32
102HY-16-16	1x11-1/2	1	3.27	83	1-1/2	1.66	42

**WARNING:** This product can expose you to chemicals including Lead, which is known to the State of California to cause cancer and birth defects or other reproductive harm. For more information go to [www.p65warnings.ca.gov](http://www.p65warnings.ca.gov).

# 107HY

## Female NPSM Pipe - Swivel - (60° Cone)

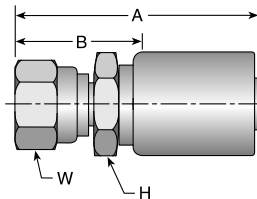

view on web page

# Part Number	Thread inch	Hose I.D. inch	A		H	W	B	
			inch	mm	inch	inch	inch	mm
107HY-4-4	1/4x18	1/4	2.66	68	9/16	11/16	1.31	33
107HY-6-4	3/8x18	1/4	2.72	69	3/4	7/8	1.38	35
107HY-6-6	3/8x18	3/8	2.55	65	3/4	7/8	1.19	30
107HY-8-8	1/2x14	1/2	2.91	74	1	1	1.56	40
107HY-12-12	3/4x14	3/4	3.22	82	1-1/4	1-1/4	1.66	42
107HY-16-16	1x11-1/2	1	3.39	86	1-3/8	1-1/2	1.78	45

**WARNING:** This product can expose you to chemicals including Lead, which is known to the State of California to cause cancer and birth defects or other reproductive harm. For more information go to [www.p65warnings.ca.gov](http://www.p65warnings.ca.gov).



## 105HY Male SAE Straight Thread with O-Ring - Rigid

# Part Number	Thread inch	Hose I.D. inch	A		H inch	B	
			inch	mm		inch	mm
105HY-4-4	7/16x20	1/4	2.33	59	9/16	0.97	25
105HY-6-4	9/16x18	1/4	2.42	61	11/16	1.06	27
105HY-6-6	9/16x18	3/8	2.38	60	11/16	1.03	26
105HY-8-6	3/4x16	3/8	2.42	61	7/8	1.06	27
105HY-8-8	3/4x16	1/2	2.59	66	7/8	1.25	32
105HY-10-8	7/8x14	1/2	2.66	68	1	1.31	33
105HY-10-10	7/8x14	5/8	2.80	71	1-1/8	1.41	36
105HY-12-8	1-1/16x12	1/2	2.81	71	1-1/4	1.47	37
105HY-12-12	1-1/16x12	3/4	2.92	74	1-1/4	1.34	34
105HY-16-12	1-5/16x12	3/4	2.92	74	1-1/2	1.34	34
105HY-16-16	1-5/16x12	1	3.08	78	1-1/2	1.47	37

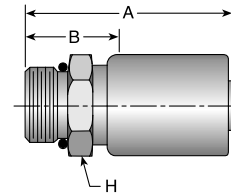

view on web page

**WARNING:** This product can expose you to chemicals including Lead, which is known to the State of California to cause cancer and birth defects or other reproductive harm. For more information go to [www.p65warnings.ca.gov](http://www.p65warnings.ca.gov).

## 10GHY Male SAE Straight Thread with O-Ring - Swivel

# Part Number	Thread inch	Hose I.D. inch	A		H inch	W inch	B	
			inch	mm			inch	mm
10GHY-4-4	7/16x20	1/4	3.00	76	9/16	5/8	1.66	42
10GHY-6-6	9/16x18	3/8	3.14	80	11/16	11/16	1.78	45
10GHY-8-6	3/4x16	3/8	3.24	82	13/16	7/8	1.88	48
10GHY-8-8	3/4x16	1/2	3.36	85	7/8	7/8	2.00	51
10GHY-10-8	7/8x14	1/2	3.44	87	1	1	2.09	53
10GHY-12-8	1-1/16x12	1/2	3.66	93	1-1/4	1-1/4	2.31	59
10GHY-16-16	1-5/16x12	1	3.95	100	1-3/8	1-1/2	2.34	59

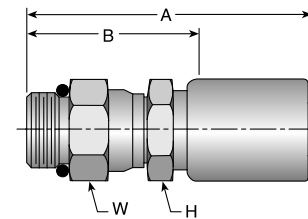

view on web page

Fitting allows minor movement under pressure to relieve stress on hose but is not to be used on extensive or continuous swiveling.

**WARNING:** This product can expose you to chemicals including Lead, which is known to the State of California to cause cancer and birth defects or other reproductive harm. For more information go to [www.p65warnings.ca.gov](http://www.p65warnings.ca.gov).

O-Ring not compatible with Phosphate Ester fluids.

### 10LHY

#### Male SAE Straight Thread with O-Ring - Swivel - 90° Elbow

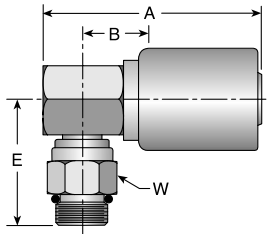

view on web page

# Part Number	Thread inch	Hose I.D. inch	A		E		W		B	
			inch	mm	inch	mm	inch	inch	mm	
10LHY-6-4	9/16x18	1/4	2.31	59	1.66	42	7/8	0.97	25	
10LHY-6-6	9/16x18	3/8	2.33	59	1.66	42	11/16	0.97	25	
10LHY-8-6	3/4x16	3/8	2.33	59	1.73	44	7/8	0.97	25	
10LHY-8-8	3/4x16	1/2	3.00	76	1.80	46	7/8	1.09	28	
10LHY-10-8	7/8x14	1/2	3.00	76	1.88	48	1	1.09	28	
10LHY-12-12	1-1/16x12	3/4	2.77	70	2.23	57	1-1/4	1.19	30	

Fitting allows minor movement under pressure to relieve stress on hose but is not to be used on extensive or continuous swiveling.

**WARNING:** This product can expose you to chemicals including Lead, which is known to the State of California to cause cancer and birth defects or other reproductive harm. For more information go to [www.p65warnings.ca.gov](http://www.p65warnings.ca.gov).

### 103HY

#### Male JIC 37° - Rigid

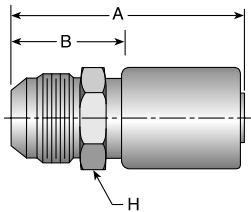

view on web page

# Part Number	Thread inch	Hose I.D. inch	A		H	B	
			inch	mm	inch	inch	mm
103HY-4-4	7/16x20	1/4	2.52	64	5/8	1.19	30
103HY-5-4	1/2x20	1/4	2.52	64	5/8	1.19	30
103HY-6-4	9/16x18	1/4	2.53	64	11/16	1.19	30
103HY-6-5	9/16x18	5/16	2.56	65	11/16	1.22	31
103HY-6-6	9/16x18	3/8	2.54	65	11/16	1.19	30
103HY-8-6	3/4x16	3/8	2.64	67	13/16	1.28	33
103HY-8-8	3/4x16	1/2	2.81	71	7/8	1.47	37
103HY-10-6	7/8x14	3/8	2.81	71	1	1.47	37
103HY-10-8	7/8x14	1/2	2.91	74	1	1.56	40
103HY-10-10	7/8x14	5/8	2.98	76	1-1/8	1.59	40
103HY-12-8	1-1/16x12	1/2	3.02	77	1-1/8	1.66	42
103HY-12-10	1-1/16x12	5/8	3.09	78	1-1/8	1.72	44
103HY-12-12	1-1/16x12	3/4	3.19	81	1-1/4	1.63	41
103HY-14-12	1-3/16x12	3/4	3.19	81	1-1/4	1.63	41
103HY-16-12	1-5/16x12	3/4	3.23	82	1-3/8	1.66	42
103HY-16-16	1-5/16x12	1	3.39	86	1-3/8	1.78	45

**WARNING:** This product can expose you to chemicals including Lead, which is known to the State of California to cause cancer and birth defects or other reproductive harm. For more information go to [www.p65warnings.ca.gov](http://www.p65warnings.ca.gov).

# 106HY

## Female JIC 37° - Swivel

# Part Number	Thread inch	Hose I.D. inch	A		H inch	W inch	B		Additional Material Stainless Steel (C)
			inch	mm			inch	mm	
106HY-3-4	3/8x24	1/4	2.58	66	9/16	1/2	1.22	31	
106HY-4-4	7/16x20	1/4	2.60	66	9/16	9/16	1.25	32	•
106HY-4-6	7/16x20	3/8	2.67	68	3/4	9/16	1.31	33	
106HY-5-4	1/2x20	1/4	2.65	67	9/16	5/8	1.31	33	
106HY-5-5	1/2x20	5/16	2.69	68	5/8	5/8	1.34	34	
106HY-5-6	1/2x20	3/8	2.73	69	3/4	5/8	1.38	35	
106HY-6-4	9/16x18	1/4	2.67	68	9/16	11/16	1.31	33	
106HY-6-5	9/16x18	5/16	2.70	69	5/8	11/16	1.34	34	
106HY-6-6	9/16x18	3/8	2.69	68	11/16	11/16	1.34	34	•
106HY-8-6	3/4x16	3/8	2.72	69	7/8	7/8	1.38	35	
106HY-8-8	3/4x16	1/2	2.90	74	7/8	7/8	1.41	40	•
106HY-8-10	3/4x16	5/8	2.98	76	1-1/8	7/8	1.59	40	
106HY-8-12	3/4x16	3/4	3.08	78	1-1/4	7/8	1.53	39	
106HY-10-6	7/8x14	3/8	2.81	71	7/8	1	1.47	37	
106HY-10-8	7/8x14	1/2	2.98	76	1	1	1.63	41	
106HY-10-10	7/8x14	5/8	3.06	78	1-1/8	1	1.69	43	
106HY-10-12	7/8x14	3/4	3.16	80	1-1/4	1	1.59	40	
106HY-12-8	1-1/16x12	1/2	3.05	77	1-1/8	1-1/4	1.69	43	
106HY-12-10	1-1/16x12	5/8	3.12	79	1-1/8	1-1/4	1.75	44	
106HY-12-12	1-1/16x12	3/4	3.22	82	1-1/4	1-1/4	1.66	42	•
106HY-12-16	1-1/16x12	1	3.38	86	1-3/8	1-1/4	1.75	44	
106HY-14-12	1-3/16x12	3/4	3.23	82	1-1/4	1 3/8	1.66	42	
106HY-16-12	1-5/16x12	3/4	3.30	84	1-3/8	1-1/2	1.72	44	
106HY-16-14	1-5/16x12	7/8	3.30	84	1-3/8	1-1/2	1.72	44	
106HY-16-16	1-5/16x12	1	3.45	88	1-3/8	1-1/2	1.84	47	•
106HY-20-16	1-5/8x12	1	3.70	94	1-3/4	2	2.09	53	
106HY-20-20	1-5/8x12	1-1/4	4.09	104	2	2	2.25	57	

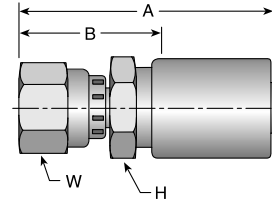

view on web page

Stainless steel fittings must be assembled with Karrykrimp 2, PHastkrimp, Superkrimp or Parkrimp 2. See CrimpSource for more information.

**WARNING:** This product can expose you to chemicals including Lead, which is known to the State of California to cause cancer and birth defects or other reproductive harm. For more information go to [www.p65warnings.ca.gov](http://www.p65warnings.ca.gov).

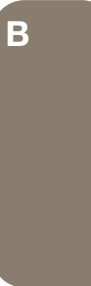

# 137HY

## Female JIC 37° - Swivel - 45° Elbow - Short Drop

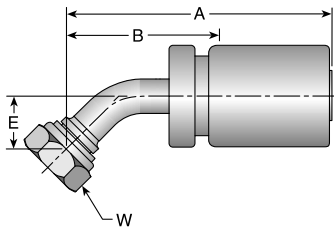

view on web page

# Part Number	Thread inch	Hose I.D. inch	A		E		W		B	
			inch	mm	inch	mm	inch	inch	mm	
137HY-4-4	7/16x20	1/4	2.59	66	0.39	10	9/16	1.32	34	
137HY-6-4	9/16x18	1/4	2.70	69	0.43	10	3/4	1.43	36	
137HY-6-6	9/16x18	3/8	2.72	69	0.43	11	11/16	1.44	37	
137HY-8-6	3/4x16	3/8	2.88	73	0.58	15	7/8	1.60	41	
137HY-8-8	3/4x16	1/2	3.10	79	0.59	15	7/8	1.81	46	
137HY-10-8	7/8x14	1/2	3.20	81	0.63	16	1	1.91	49	
137HY-10-10	7/8x14	5/8	3.29	84	0.63	16	1	1.93	49	
137HY-12-12	1-1/16x12	3/4	3.82	97	0.83	21	1-1/4	2.29	58	
137HY-16-16	1-5/16x12	1	4.31	109	0.89	23	1-1/2	2.69	68	

**WARNING:** This product can expose you to chemicals including Lead, which is known to the State of California to cause cancer and birth defects or other reproductive harm. For more information go to [www.p65warnings.ca.gov](http://www.p65warnings.ca.gov).

# 139HY

## Female JIC 37° - Swivel - 90° Elbow - Short Drop

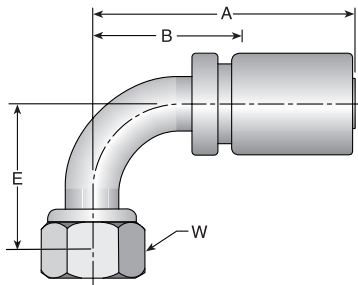

view on web page

# Part Number	Thread inch	Hose I.D. inch	A		E		W		B	
			inch	mm	inch	mm	inch	inch	mm	
139HY-4-4	7/16x20	1/4	2.40	61	0.83	21	9/16	1.13	29	
139HY-5-4	1/2x20	1/4	2.50	64	0.83	21	5/8	1.23	31	
139HY-6-4	9/16x18	1/4	2.65	67	0.91	23	3/4	1.38	35	
139HY-6-6	9/16x18	3/8	2.57	65	0.91	23	11/16	1.29	33	
139HY-8-6	3/4x16	3/8	2.64	67	1.14	29	7/8	1.37	35	
139HY-8-8	3/4x16	1/2	2.85	72	1.14	29	7/8	1.56	40	
139HY-10-8	7/8x14	1/2	3.01	76	1.26	32	1	1.72	44	
139HY-10-10	7/8x14	5/8	3.09	78	1.26	32	1	1.73	44	
139HY-12-8	1-1/16x12	1/2	3.61	92	1.83	46	1-1/4	2.25	57	
139HY-12-10	1-1/16x12	5/8	3.61	92	1.89	48	1-1/4	2.25	57	
139HY-12-12	1-1/16x12	3/4	3.68	93	1.89	48	1-1/4	2.15	55	
139HY-16-12	1-5/16x12	3/4	4.33	110	2.14	54	1-1/2	2.78	71	
139HY-16-16	1-5/16x12	1	4.31	109	2.31	59	1-1/2	2.69	68	

**WARNING:** This product can expose you to chemicals including Lead, which is known to the State of California to cause cancer and birth defects or other reproductive harm. For more information go to [www.p65warnings.ca.gov](http://www.p65warnings.ca.gov).

# 141HY

## Female JIC 37° - Swivel - 90° Elbow - Long Drop

# Part Number	Thread inch	Hose I.D. inch	A		E		W		B	
			inch	mm	inch	mm	inch	inch	inch	mm
141HY-4-4	7/16x20	1/4	2.68	68	1.81	46	9/16	1.41	36	
141HY-6-4	9/16x18	1/4	2.89	73	2.13	54	11/16	1.62	41	
141HY-6-6	9/16x18	3/8	2.76	70	2.13	54	11/16	1.49	39	
141HY-8-6	3/4x16	3/8	2.85	72	2.52	64	7/8	1.58	40	
141HY-8-8	3/4x16	1/2	2.89	73	2.52	64	7/8	1.60	41	
141HY-10-8	7/8x14	1/2	3.01	76	2.76	70	1	1.72	44	
141HY-12-12	1-1/16x12	3/4	3.59	91	3.73	95	1-1/4	2.03	52	
141HY-16-16	1-5/16x12	1	4.56	116	4.33	110	1-1/2	2.94	75	

**WARNING:** This product can expose you to chemicals including Lead, which is known to the State of California to cause cancer and birth defects or other reproductive harm. For more information go to [www.p65warnings.ca.gov](http://www.p65warnings.ca.gov).

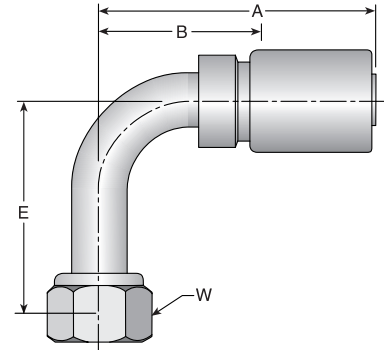

[view on web page](#)

# 108HY

## Female SAE 45° - Swivel

# Part Number	Thread inch	Hose I.D. inch	A		H	W	B	
			inch	mm	inch	inch	inch	mm
108HY-5-5	1/2x20	5/16	2.68	68	5/8	5/8	1.34	34
108HY-6-4	5/8x18	1/4	2.73	69	11/16	3/4	1.38	35
108HY-6-5	5/8x18	5/16	2.76	70	5/8	3/4	1.41	36
108HY-6-6	5/8x18	3/8	2.75	70	11/16	3/4	1.41	36
108HY-8-8	3/4x16	1/2	2.90	74	7/8	7/8	1.56	40
108HY-8-12	3/4x16	3/4	3.17	81	1-1/4	7/8	1.59	40
108HY-12-12	1-1/16x12	3/4	3.41	87	1-1/4	1-1/4	1.84	47

**WARNING:** This product can expose you to chemicals including Lead, which is known to the State of California to cause cancer and birth defects or other reproductive harm. For more information go to [www.p65warnings.ca.gov](http://www.p65warnings.ca.gov).

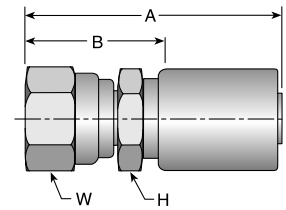

[view on web page](#)

### 177HY Female SAE 45° - Swivel - 45° Elbow

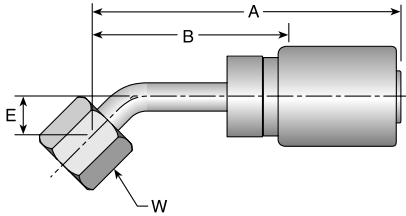

# Part Number	Thread inch	Hose I.D. inch	A		E		W		B	
			inch	mm	inch	mm	inch	inch	mm	
177HY-12-12	1-1/16x14	3/4	4.03	102	0.77	20	1-1/4	2.44	62	

**WARNING:** This product can expose you to chemicals including Lead, which is known to the State of California to cause cancer and birth defects or other reproductive harm. For more information go to [www.p65warnings.ca.gov](http://www.p65warnings.ca.gov).

### 179HY Female SAE 45° - Swivel - 90° Elbow

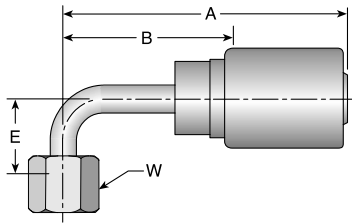

# Part Number	Thread inch	Hose I.D. inch	A		E		W		B	
			inch	mm	inch	mm	inch	inch	mm	
179HY-6-6	5/8x18	3/8	3.23	82	0.86	22	3/4	1.88	48	

**WARNING:** This product can expose you to chemicals including Lead, which is known to the State of California to cause cancer and birth defects or other reproductive harm. For more information go to [www.p65warnings.ca.gov](http://www.p65warnings.ca.gov).

view on web page

### 111HY Male Ferulok Flareless - Rigid (24° Cone w/Nut and Ferrule)

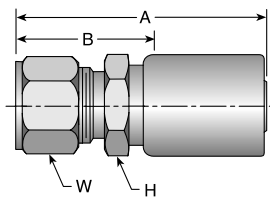

view on web page

# Part Number	Thread inch	Hose I.D. inch	A		H	W	B	
			inch	mm	inch	inch	inch	mm
111HY-4-4	7/16x20	1/4	2.42	61	9/16	9/16	1.06	27
111HY-6-6	9/16x18	3/8	2.45	62	11/16	11/16	1.09	28
111HY-8-6	3/4x16	3/8	2.61	66	7/8	7/8	1.25	32
111HY-8-8	3/4x16	1/2	2.72	69	7/8	7/8	1.38	35
111HY-10-8	7/8x14	1/2	2.78	71	1	1	1.44	37
111HY-12-12	1-1/16x12	3/4	3.02	77	1-1/4	1-1/4	1.44	37

The Parker Ferrule-Fix fitting makes it possible to salvage the bent tube section from a hose assembly for quick, easy on the job repairs. For additional information see Ferrule-Fix installation instructions in the Technical Section.

**WARNING:** This product can expose you to chemicals including Lead, which is known to the State of California to cause cancer and birth defects or other reproductive harm. For more information go to [www.p65warnings.ca.gov](http://www.p65warnings.ca.gov).

# 1GJHY

## Female Grease Connection - SPL - PTF Taper Thread - Rigid - 1/2x27

# Part Number	Thread inch	Hose I.D. inch	A		H inch	B	
			inch	mm		inch	mm
1GJHY-8-4	1/2x27	1/4	2.41	61	3/4	1.06	27

**WARNING:** This product can expose you to chemicals including Lead, which is known to the State of California to cause cancer and birth defects or other reproductive harm. For more information go to [www.p65warnings.ca.gov](http://www.p65warnings.ca.gov).

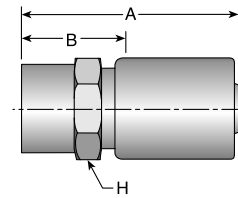

[view on web page](#)

# 128HY

## Male Inverted SAE 45° - Swivel

# Part Number	Thread inch	Hose I.D. inch	A		W inch	B	
			inch	mm		inch	mm
128HY-4-4	7/16x24	1/4	3.28	83	7/16	1.94	49
128HY-5-4	1/2x20	1/4	3.34	85	1/2	2.00	51
128HY-6-5	5/8x18	5/16	3.75	95	5/8	2.41	61
128HY-6-6	5/8x18	3/8	3.73	95	5/8	2.38	60

**WARNING:** This product can expose you to chemicals including Lead, which is known to the State of California to cause cancer and birth defects or other reproductive harm. For more information go to [www.p65warnings.ca.gov](http://www.p65warnings.ca.gov).

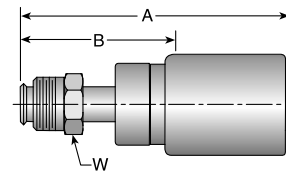

[view on web page](#)

# 167HY

## Male Inverted SAE 45° - Swivel - 45° Elbow

# Part Number	Thread inch	Hose I.D. inch	A		E		W inch	B	
			inch	mm	inch	mm		inch	mm
167HY-6-6	5/8x18	3/8	4.16	106	0.94	24	5/8	2.81	71

**WARNING:** This product can expose you to chemicals including Lead, which is known to the State of California to cause cancer and birth defects or other reproductive harm. For more information go to [www.p65warnings.ca.gov](http://www.p65warnings.ca.gov).

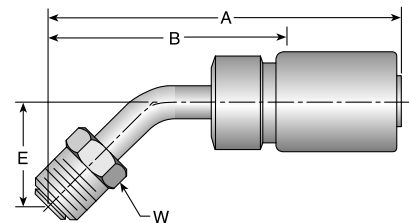

[view on web page](#)

A

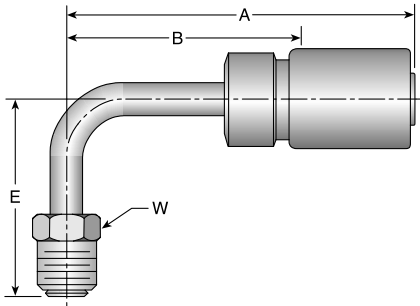

view on web page

## 169HY

### Male Inverted SAE 45° - Swivel - 90° Elbow

# Part Number	Thread inch	Hose I.D. inch	A		E		W	B	
			inch	mm	inch	mm	inch	inch	mm
169HY-5-4	1/2x20	1/4	3.52	89	1.66	42	1/2	2.16	55
169HY-6-6	5/8x18	3/8	4.03	102	1.69	43	5/8	2.69	68

**WARNING:** This product can expose you to chemicals including Lead, which is known to the State of California to cause cancer and birth defects or other reproductive harm. For more information go to [www.p65warnings.ca.gov](http://www.p65warnings.ca.gov).

B

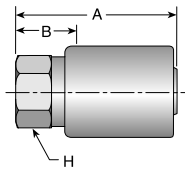

view on web page

## 129HY

### Female Inverted SAE 45° - Rigid

# Part Number	Thread inch	Hose I.D. inch	A		H	B	
			inch	mm	inch	inch	mm
129HY-5-4	1/2x20	1/4	2.25	57	5/8	0.91	23

**WARNING:** This product can expose you to chemicals including Lead, which is known to the State of California to cause cancer and birth defects or other reproductive harm. For more information go to [www.p65warnings.ca.gov](http://www.p65warnings.ca.gov).

C

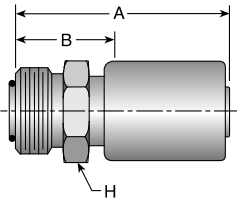

view on web page

## 1J0HY

### Male Seal-Lok® - Rigid - (with O-Ring) SAE J516 (Apr2016)

# Part Number	Thread inch	Hose I.D. inch	A		H	B	
			inch	mm	inch	inch	mm
1J0HY-4-4	9/16x18	1/4	2.36	60	5/8	1.00	25
1J0HY-6-6	11/16x16	3/8	2.49	63	3/4	1.13	29
1J0HY-8-8	13/16x16	1/2	2.69	68	7/8	1.34	34
1J0HY-12-8	1-3/16x12	1/2	2.91	74	1-1/4	1.56	40

**WARNING:** This product can expose you to chemicals including Lead, which is known to the State of California to cause cancer and birth defects or other reproductive harm. For more information go to [www.p65warnings.ca.gov](http://www.p65warnings.ca.gov).

D

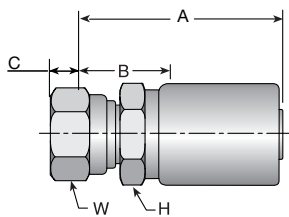

view on web page

## 1JCHY

### Female Seal-Lok® - Swivel - Short ISO 12151-1 - SWSA

# Part Number	Thread inch	Hose I.D. inch	A		C		H	W	B	
			inch	mm	inch	mm	inch	inch	inch	mm
1JCHY-4-4	9/16x18	1/4	2.61	66	0.31	7,8	9/16	11/16	0.94	24
1JCHY-6-6	11/16x16	3/8	2.69	68	0.34	8,7	11/16	13/16	0.94	24
1JCHY-8-8	13/16x16	1/2	2.91	74	0.43	11,0	7/8	15/16	1.13	29
1JCHY-12-12	1-3/16x12	3/4	3.31	84	0.55	14,0	1-1/4	1-3/8	1.13	29

**WARNING:** This product can expose you to chemicals including Lead, which is known to the State of California to cause cancer and birth defects or other reproductive harm. For more information go to [www.p65warnings.ca.gov](http://www.p65warnings.ca.gov).

See Accessories Section for O-Rings.



# 1JSHY

## Female Seal-Lok® - Swivel - Long

ISO 12151-1 - SWSB

# Part Number	Thread inch	Hose I.D. inch	A		H inch	W inch	B	
			inch	mm			inch	mm
1JSHY-4-4	9/16x18	1/4	2.59	66	9/16	11/16	1.25	32
1JSHY-6-4	11/16x16	1/4	2.67	68	5/8	13/16	1.31	33
1JSHY-6-5	11/16x16	5/16	2.70	69	5/8	13/16	1.34	34
1JSHY-6-6	11/16x16	3/8	2.75	70	11/16	13/16	1.34	34
1JSHY-8-6	13/16x16	3/8	2.84	72	7/8	15/16	1.50	38
1JSHY-8-8	13/16x16	1/2	2.95	75	7/8	15/16	1.59	40
1JSHY-10-8	1x14	1/2	3.16	80	15/16	1-1/8	1.81	46
1JSHY-10-10	1x14	5/8	3.17	81	1-1/8	1-1/8	1.78	45
1JSHY-10-12	1x14	3/4	3.27	83	1-1/4	1-1/8	1.69	43
1JSHY-12-10	1-3/16x12	5/8	3.20	81	1-1/8	1-3/8	1.81	46
1JSHY-12-12	1-3/16x12	3/4	3.30	84	1-1/4	1-3/8	1.72	44
1JSHY-16-12	1-7/16x12	3/4	3.44	87	1-3/8	1-5/8	1.88	48
1JSHY-16-16	1-7/16x12	1	3.59	91	1-3/8	1-5/8	1.97	50
1JSHY-20-16	1-11/16x12	1	3.47	88	1-5/8	1-7/8	1.75	59
1JSHY-20-20	1-11/16x12	1-1/4	3.98	101	1-3/4	1-7/8	2.16	55

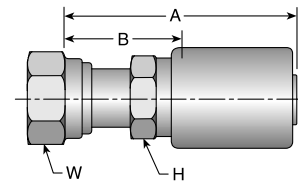

view on web page

**WARNING:** This product can expose you to chemicals including Lead, which is known to the State of California to cause cancer and birth defects or other reproductive harm. For more information go to [www.p65warnings.ca.gov](http://www.p65warnings.ca.gov).

# 1J7HY

## Female Seal-Lok® - Swivel - 45° Elbow

ISO 12151-1 - SWE45

# Part Number	Thread inch	Hose I.D. inch	A		E		W inch	B	
			inch	mm	inch	mm		inch	mm
1J7HY-4-4	9/16x18	1/4	2.59	66	0.39	10	11/16	1.32	34
1J7HY-6-4	11/16x16	1/4	2.70	69	0.43	11	13/16	1.43	36
1J7HY-6-6	11/16x16	3/8	2.72	69	0.43	11	13/16	1.44	37
1J7HY-8-4	13/16x16	1/4	2.95	75	0.59	15	15/16	1.68	43
1J7HY-8-6	13/16x16	3/8	2.89	73	0.59	15	15/16	1.62	41
1J7HY-8-8	13/16x16	1/2	3.10	79	0.59	15	15/16	1.81	46
1J7HY-10-8	1x14	1/2	3.20	81	0.63	16	1-1/8	1.91	49
1J7HY-10-10	1x14	5/8	3.29	84	0.63	16	1-1/8	1.93	49
1J7HY-12-12	1-3/16x12	3/4	3.82	97	0.83	21	1-3/8	2.29	58
1J7HY-16-16	1-7/16x12	1	4.55	116	0.97	25	1-5/8	2.94	75

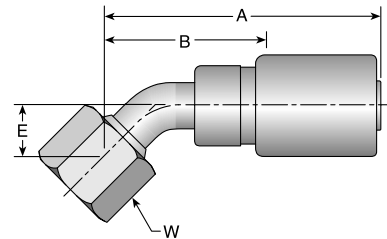

view on web page

**WARNING:** This product can expose you to chemicals including Lead, which is known to the State of California to cause cancer and birth defects or other reproductive harm. For more information go to [www.p65warnings.ca.gov](http://www.p65warnings.ca.gov).

See Accessories Section for O-Rings.

# 1J9HY

## Female Seal-Lok® - Swivel - 90° Elbow - Short Drop

ISO 12151-1 - SWES90

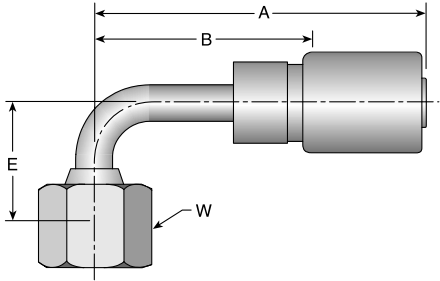

view on web page

# Part Number	Thread inch	Hose I.D. inch	A		E		W		B	
			inch	mm	inch	mm	inch	inch	mm	
1J9HY-4-4	9/16x18	1/4	2.40	61	0.83	21	11/16	1.13	29	
1J9HY-4-6	9/16x18	3/8	3.08	78	0.83	21	11/16	1.72	44	
1J9HY-6-4	11/16x16	1/4	2.65	67	0.91	23	13/16	1.38	35	
1J9HY-6-5	11/16x16	5/16	3/14	80		23	13/16	1.72	44	
1J9HY-6-6	11/16x16	3/8	2.57	65	0.91	23	13/16	1.29	33	
1J9HY-8-6	13/16x16	3/8	2.64	67	1.14	29	15/16	1.37	35	
1J9HY-8-8	13/16x16	1/2	2.85	72	1.14	29	15/16	1.56	40	
1J9HY-10-8	1x14	1/2	3.01	76	1.26	32	1-1/8	1.72	44	
1J9HY-10-10	1x14	5/8	3.09	78	1.26	32	1-1/8	1.73	44	
1J9HY-10-12	1x14	3/4	3.52	89	1.33	34	1-1/8	1.97	50	
1J9HY-12-10	1-3/16x12	5/8	3.61	92	1.89	48	1-3/8	2.25	57	
1J9HY-12-12	1-3/16x12	3/4	3.68	93	1.89	48	1-3/8	2.15	55	
1J9HY-16-12	1-7/16x12	3/4	4.27	108	2.25	57	1-5/8	2.69	68	
1J9HY-16-16	1-7/16x12	1	4.45	113	2.25	57	1-5/8	2.84	72	

**WARNING:** This product can expose you to chemicals including Lead, which is known to the State of California to cause cancer and birth defects or other reproductive harm. For more information go to [www.p65warnings.ca.gov](http://www.p65warnings.ca.gov).

# 1J1HY

## Female Seal-Lok® - Swivel - 90° Elbow - Long Drop

ISO 12151-1 - SWEL90

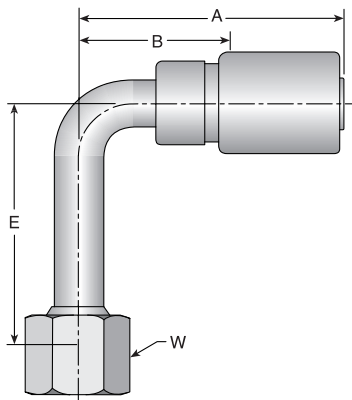

view on web page

# Part Number	Thread inch	Hose I.D. inch	A		E		W		B	
			inch	mm	inch	mm	inch	inch	mm	
1J1HY-4-4	9/16x18	1/4	2.68	68	1.81	46	11/16	1.41	36	
1J1HY-6-6	11/16x16	3/8	2.76	70	2.13	54	13/16	1.49	38	
1J1HY-8-8	13/16x16	1/2	2.94	75	2.52	64	15/16	1.65	42	
1J1HY-10-10	1x14	5/8	3.42	87	2.76	70	1-1/8	2.03	52	

**WARNING:** This product can expose you to chemicals including Lead, which is known to the State of California to cause cancer and birth defects or other reproductive harm. For more information go to [www.p65warnings.ca.gov](http://www.p65warnings.ca.gov).

See Accessories Section for O-Rings.

### 1D0HY

**Male Metric L - Rigid - (24° Cone)**  
ISO 12151-2

# Part Number	Thread mm	Hose I.D. inch	A		H mm	B	
			inch	mm		inch	mm
1D0HY-15-6	15 M22x1.5	3/8	2.52	64	24	1.16	29

**WARNING:** This product can expose you to chemicals including Lead, which is known to the State of California to cause cancer and birth defects or other reproductive harm. For more information go to [www.p65warnings.ca.gov](http://www.p65warnings.ca.gov).

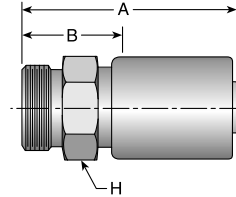

### 13DHY

**Male Standpipe Metric S - Rigid**  
End Connection per ISO 8434-1-SDS

# Part Number	R mm	Hose I.D. inch	A		B	
			inch	mm	inch	mm
13DHY-16-8	16	1/2	3.53	90	2.16	55
13DHY-30-16	30	1	4.15	105	2.53	64

**WARNING:** This product can expose you to chemicals including Lead, which is known to the State of California to cause cancer and birth defects or other reproductive harm. For more information go to [www.p65warnings.ca.gov](http://www.p65warnings.ca.gov).

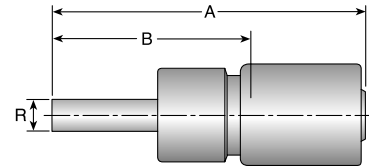

### 1D9HY

**Male BSP Parallel Pipe - Rigid - (60° Cone)**  
ISO 228-1

# Part Number	Thread inch	Hose I.D. inch	A		H inch	B	
			inch	mm		inch	mm
1D9HY-8-8	1/2x14	1/2	2.83	72	1-1/16	1.47	37

When used in a port, a bonded seal must be used. See Accessories Section for more information.

**WARNING:** This product can expose you to chemicals including Lead, which is known to the State of California to cause cancer and birth defects or other reproductive harm. For more information go to [www.p65warnings.ca.gov](http://www.p65warnings.ca.gov).

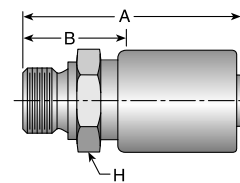

view on web page

Metric L: Mates with EO "L" Series Fittings.  
Metric S: Mates with EO "S" Series Fittings.

# 1GUHY

## Female BSP Parallel Pipe - Swivel - (60° Cone)

ISO 228-1

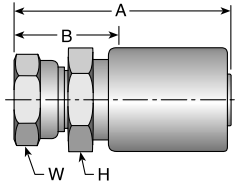

view on web page

# Part Number	Thread inch	Hose I.D. inch	A		H		W		B	
			inch	mm	inch	inch	inch	mm		
1GUHY-4-4	1/4x19	1/4	2.62	67	9/16	11/16	1.28	33		
1GUHY-6-4	3/8x19	1/4	2.69	68	3/4	7/8	1.34	34		
1GUHY-6-6	3/8x19	3/8	2.70	69	3/4	7/8	1.34	34		
1GUHY-8-6	1/2x14	3/8	2.84	72	7/8	1	1.50	38		
1GUHY-8-8	1/2x14	1/2	3.02	77	7/8	1	1.66	42		
1GUHY-12-12	3/4x14	3/4	3.25	83	1-1/4	1-1/4	1.69	43		
1GUHY-16-16	1x11	1	3.45	88	1-3/8	1-1/2	1.84	47		

**WARNING:** This product can expose you to chemicals including Lead, which is known to the State of California to cause cancer and birth defects or other reproductive harm. For more information go to [www.p65warnings.ca.gov](http://www.p65warnings.ca.gov).

# 1UTHY

## Male BSP Taper Pipe - Rigid - (60° Cone)

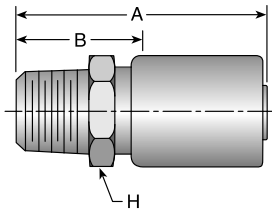

# Part Number	Thread inch	Hose I.D. inch	A		H	B	
			inch	mm	inch	inch	mm
1UTHY-2-4	1/8x28	1/4	2.34	59	9/16	1.00	25

**WARNING:** This product can expose you to chemicals including Lead, which is known to the State of California to cause cancer and birth defects or other reproductive harm. For more information go to [www.p65warnings.ca.gov](http://www.p65warnings.ca.gov).

# 1XUHY



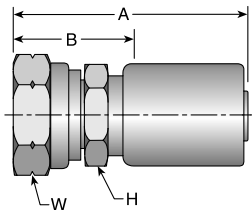







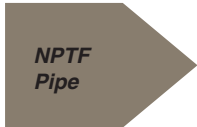
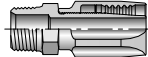

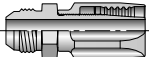

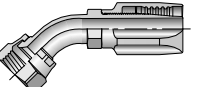
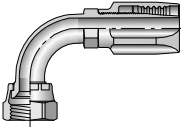
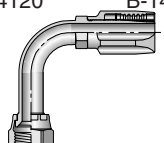

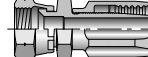
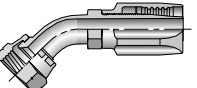
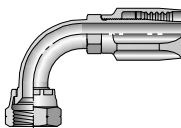
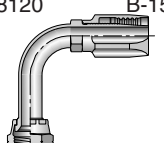

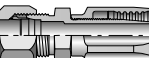

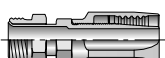
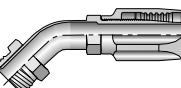
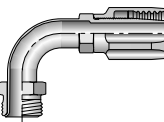
## Female Metric Swivel - (30° Flare)

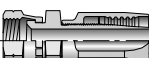

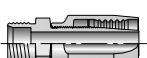
view on web page

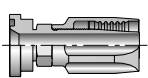
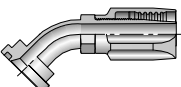
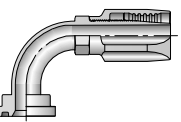
# Part Number	Thread mm		Hose I.D. inch	A		H	W	B	
				inch	mm	mm	mm	inch	mm
1XUHY-10-10	24	M24x1.5	5/8	3.22	82	30	30	1.84	47
1XUHY-12-12	30	M30x1.5	3/4	3.31	84	32	38	1.75	44
1XUHY-16-16	33	M33x1.5	1	3.62	92	36	41	2.00	51

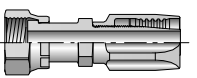
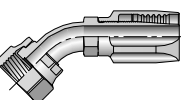
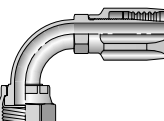
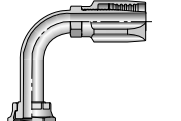
**WARNING:** This product can expose you to chemicals including Lead, which is known to the State of California to cause cancer and birth defects or other reproductive harm. For more information go to [www.p65warnings.ca.gov](http://www.p65warnings.ca.gov).

	20120 B-146  Male - Rigid		20320 B-146  Male - Rigid	20620 B-147  Female - Swivel	23720 B-147  Female - Swivel 45° Elbow - Short
23920 B-148  Female - Swivel 90° Elbow - Short	24120 B-148  Female - Swivel 90° Elbow - Long		20420 B-148  Male - Rigid	20820 B-149  Female - Swivel	27720 B-149  Female - Swivel 45° Elbow
27920 B-149  Female - Swivel 90° Elbow	28120 B-150  Female - Swivel 90° Elbow - Long		21120 B-150  Male - Rigid		22820 B-150  Male - Swivel
26720 B-150  Male - Swivel 45° Elbow	26920 B-151  Male - Swivel 90° Elbow		23220 B-151  Female - Swivel		26120 B-151  Male (without Nut or Sleeve)
	21520 B-151  Flange	21720 B-152  45° Elbow	21920 B-152  90° Elbow		2JS20 B-152  Female - Swivel Long
2J720 B-152  Female - Swivel 45° Elbow	2J920 B-153  Female - Swivel 90° Elbow - Short	2J120 B-153  Female - Swivel 90° Elbow - Long		20 Series B-154  Assembly Instructions	

A

B

C

D

E

## 20120 Male NPTF Pipe - Rigid

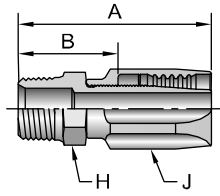

view on web page

# Part Number	Thread inch	Hose I.D. inch	A		H		J		B		Additional Material Brass (B)
			inch	mm	inch	inch	inch	mm			
20120-2-4	1/8x27	3/16	1.72	44	7/16	5/8	0.94	24			
20120-2-5	1/8x27	1/4	1.82	46	1/2	11/16	0.99	25			
20120-4-4	1/4x18	3/16	1.93	49	9/16	5/8	1.15	29			
20120-4-5	1/4x18	1/4	2.01	51	9/16	11/16	1.18	30			
20120-4-6	1/4x18	5/16	2.11	54	9/16	13/16	1.19	30			
20120-6-6	3/8x18	5/16	2.20	56	3/4	13/16	1.28	33			
20120-6-8	3/8x18	13/32	2.48	63	3/4	15/16	1.39	35			
20120-8-8	1/2x14	13/32	2.73	69	7/8	15/16	1.64	42			
20120-8-10	1/2x14	1/2	2.88	73	7/8	1-1/8	1.66	42			
20120-12-10	3/4x14	1/2	2.95	75	1-1/16	1-1/8	1.73	44			
20120-12-12	3/4x14	5/8	3.25	83	1-1/16	1-1/4	1.75	44			
20120-12-16	3/4x14	7/8	2.81	71	1-3/8	1-7/16	1.62	41			
20120-16-16	1x11-1/2	7/8	2.99	76	1-3/8	1-7/16	1.80	46			
20120-20-20	1-1/4x11-1/2	1-1/8	3.24	82	1-3/4	1-3/4	1.96	50			
20120-24-24	1-1/2x11-1/2	1-3/8	3.50	89	2	2	2.13	54		•	
20120-32-32	2 x11-1/2	1-13/16	4.05	103	2-1/2	2-1/2	2.31	59		•	

**WARNING:** This product can expose you to chemicals including Lead, which is known to the State of California to cause cancer and birth defects or other reproductive harm. For more information go to [www.p65warnings.ca.gov](http://www.p65warnings.ca.gov).

## 20320 Male JIC 37° - Rigid

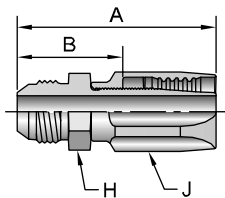

view on web page

# Part Number	Thread inch		Hose I.D. inch	A		H		J		B	
	inch	mm		inch	mm	inch	inch	inch	mm		
20320-4-4	1/4	7/16x20	3/16	1.83	46	1/2	5/8	1.05	27		
20320-6-6	3/8	9/16x18	5/16	2.11	54	5/8	13/16	1.19	30		
20320-8-8	1/2	3/4x16	13/32	2.57	65	13/16	15/16	1.48	38		
20320-10-10	5/8	7/8x14	1/2	2.88	73	15/16	1-1/8	1.66	42		
20320-12-12	3/4	1-1/16x12	5/8	3.35	85	1-1/8	1-1/4	1.85	47		
20320-16-16	1	1-5/16x12	7/8	2.95	75	1-3/8	1-7/16	1.76	45		

**WARNING:** This product can expose you to chemicals including Lead, which is known to the State of California to cause cancer and birth defects or other reproductive harm. For more information go to [www.p65warnings.ca.gov](http://www.p65warnings.ca.gov).

## 20620

### Female JIC 37° - Swivel

# Part Number	Thread		Hose I.D. inch	A		H inch	J inch	W inch	B		Additional Material Stainless Steel (C)
	inch	inch		inch	mm				inch	mm	
20620-4-4	1/4	7/16x20	3/16	1.94	49	9/16	5/8	9/16	1.16	29	•
20620-4-5	1/4	7/16x20	1/4	2.04	52	9/16	11/16	9/16	1.21	31	
20620-5-5	5/16	1/2x20	1/4	2.12	54	5/8	11/16	5/8	1.29	33	
20620-6-5	3/8	9/16x18	1/4	2.19	56	11/16	11/16	11/16	1.36	35	
20620-6-6	3/8	9/16x18	5/16	2.32	59	11/16	13/16	11/16	1.40	36	•
20620-8-6	1/2	3/4x16	5/16	2.44	62	7/8	13/16	7/8	1.52	39	
20620-8-8	1/2	3/4x16	13/32	2.79	71	7/8	15/16	7/8	1.70	43	•
20620-8-10	1/2	3/4x16	1/2	2.99	76	7/8	1-1/8	7/8	1.77	45	
20620-10-8	5/8	7/8x14	13/32	2.94	75	7/8	15/16	1	1.85	47	
20620-10-10	5/8	7/8x14	1/2	3.10	79	1	1-1/8	1	1.88	48	•
20620-10-12	5/8	7/8x14	5/8	3.40	86	1	1-1/4	1	1.90	48	
20620-12-12	3/4	1-1/16x12	5/8	3.49	89	1-1/4	1-1/4	1-1/4	1.99	51	•
20620-16-16	1	1-5/16x12	7/8	3.20	81	1-1/2	1-7/16	1-1/2	2.01	51	•
20620-20-20	1-1/4	1-5/8x12	1-1/8	3.56	90	2	1-3/4	2	2.28	58	
20620-24-24	1-1/2	1-7/8x12	1-3/8	3.95	100	2-1/4	2	2-1/4	2.58	66	
20620-32-32	2	2-1/2x12	1-13/16	4.71	120	2-7/8	2-1/2	2-7/8	2.97	75	

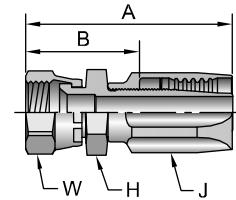

view on web page

**WARNING:** This product can expose you to chemicals including Lead, which is known to the State of California to cause cancer and birth defects or other reproductive harm. For more information go to [www.p65warnings.ca.gov](http://www.p65warnings.ca.gov).

## 23720

### Female JIC 37° - Swivel - 45° Elbow - Short Drop

# Part Number	Thread		Hose I.D. inch	A		E		H inch	J inch	W inch	B	
	inch	inch		inch	mm	inch	mm				inch	mm
23720-4-4	1/4	7/16x20	3/16	2.08	53	0.33	8	3/8	5/8	9/16	1.30	33
23720-5-5	5/16	1/2x20	1/4	2.36	60	0.39	10	1/2	11/16	5/8	1.55	39
23720-6-6	3/8	9/16x18	5/16	2.45	62	0.39	10	1/2	13/16	11/16	1.53	39
23720-8-6	1/2	3/4x16	5/16	2.77	70	0.55	14	5/8	13/16	7/8	1.85	47
23720-10-10	5/8	7/8x14	1/2	3.35	85	0.63	16	7/8	1-1/8	1	2.14	54
23720-12-12	3/4	1-1/16x12	5/8	3.94	100	0.79	20	7/8	1-1/4	1-1/4	2.44	62
23720-16-16	1	1-5/16x12	7/8	3.73	95	0.90	23	1-1/8	1-7/16	1-1/2	2.54	65
23720-20-20	1-1/4	1-5/8x12	1-1/8	4.17	106	1.19	30	1-1/2	1-3/4	2	2.89	73

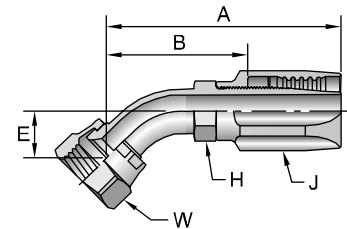

view on web page

**WARNING:** This product can expose you to chemicals including Lead, which is known to the State of California to cause cancer and birth defects or other reproductive harm. For more information go to [www.p65warnings.ca.gov](http://www.p65warnings.ca.gov).

## 23920

### Female JIC 37° - Swivel - 90° Elbow - Short Drop

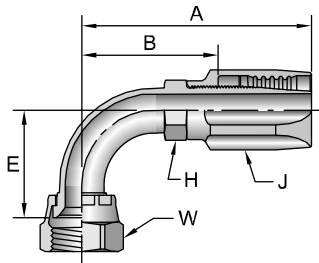

view on web page

# Part Number	Thread		Hose I.D. inch	A		E		H inch	J inch	W inch	B	
	inch			inch	mm	inch	mm				inch	mm
23920-4-4	1/4	7/16x20	3/16	1.91	49	0.83	21	3/8	5/8	9/16	1.13	29
23920-5-5	5/16	1/2x20	1/4	2.28	58	0.83	21	1/2	11/16	5/8	1.47	37
23920-6-6	3/8	9/16x18	5/16	2.35	60	0.90	23	1/2	13/16	11/16	1.43	36
23920-8-8	1/2	3/4x16	13/32	2.88	73	1.09	28	5/8	15/16	7/8	1.79	45
23920-10-10	5/8	7/8x14	1/2	3.20	81	1.26	32	7/8	1-1/8	1	1.98	50
23920-12-12	3/4	1-1/16x12	5/8	3.86	98	1.82	46	7/8	1-1/4	1-1/4	2.36	60
23920-16-16	1	1-5/16x12	7/8	3.69	94	2.14	54	1-1/8	1-7/16	1-1/2	2.50	64
23920-20-20	1-1/4	1-5/8x12	1-1/8	4.01	102	2.59	66	1-1/2	1-3/4	2	2.73	69
23920-24-24	1-1/2	1-7/8x12	1-3/8	4.43	113	2.82	72	1-3/4	2	2-1/4	3.06	78

**WARNING:** This product can expose you to chemicals including Lead, which is known to the State of California to cause cancer and birth defects or other reproductive harm. For more information go to [www.p65warnings.ca.gov](http://www.p65warnings.ca.gov).

## 24120

### Female JIC 37° - Swivel - 90° Elbow - Long Drop

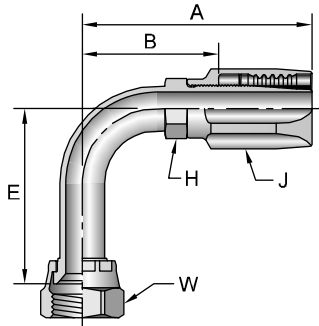

view on web page

# Part Number	Thread		Hose I.D. inch	A		E		H inch	J inch	W inch	B	
	inch			inch	mm	inch	mm				inch	mm
24120-4-4	1/4	7/16x20	3/16	2.08	53	1.80	46	3/8	5/8	9/16	1.30	33
24120-6-6	3/8	9/16x18	5/16	2.34	59	2.18	55	1/2	13/16	11/16	1.42	36
24120-8-8	1/2	3/4x16	13/32	2.95	75	2.43	62	5/8	15/16	7/8	1.86	47
24120-10-10	5/8	7/8x14	1/2	3.27	83	2.76	70	7/8	1-1/8	1	2.05	52
24120-12-12	3/4	1-1/16x12	5/8	3.78	96	3.74	95	7/8	1-1/4	1-1/4	2.28	58

**WARNING:** This product can expose you to chemicals including Lead, which is known to the State of California to cause cancer and birth defects or other reproductive harm. For more information go to [www.p65warnings.ca.gov](http://www.p65warnings.ca.gov).

## 20420

### Male SAE 45° - Rigid

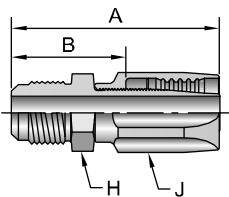

view on web page

# Part Number	Thread		Hose I.D. inch	A		H inch	J inch	B	
	inch			inch	mm			inch	mm
20420-4-4	1/4	7/16x20	3/16	1.80	46	1/2	5/8	1.02	26
20420-6-6	3/8	5/8x18	5/16	2.17	55	11/16	13/16	1.25	32
20420-8-8	1/2	3/4x16	13/32	2.67	68	13/16	15/16	1.58	40

**WARNING:** This product can expose you to chemicals including Lead, which is known to the State of California to cause cancer and birth defects or other reproductive harm. For more information go to [www.p65warnings.ca.gov](http://www.p65warnings.ca.gov).



## 20820

### Female SAE 45° - Swivel

# Part Number	Thread		Hose I.D. inch	A		H inch	J inch	W inch	B	
	inch	inch		inch	mm				inch	mm
20820-4-4	1/4	7/16x20	3/16	1.94	49	9/16	5/8	9/16	1.16	29
20820-5-5	5/16	1/2x20	1/4	2.12	54	5/8	11-16	5/8	1.29	33
20820-6-6	3/8	5/8x18	5/16	2.36	60	3/4	13/16	3/4	1.44	37
20820-8-8	1/2	3/4x16	13/32	2.79	71	7/8	15/16	7/8	1.70	43
20820-8-10	1/2	3/4x16	1/2	2.99	76	7/8	1-1/8	7/8	1.77	45
20820-10-10	5/8	7/8x14	1/2	3.10	79	1	1-1/8	1	1.88	48
20820-12-12	3/4	1-1/16x14	5/8	3.49	89	1-1/4	1-1/4	1-1/4	1.99	51

**WARNING:** This product can expose you to chemicals including Lead, which is known to the State of California to cause cancer and birth defects or other reproductive harm. For more information go to [www.p65warnings.ca.gov](http://www.p65warnings.ca.gov).

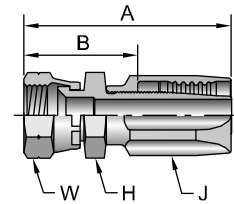

view on web page

## 27720

### Female SAE 45° - Swivel - 45° Elbow

# Part Number	Thread		Hose I.D. inch	A		E		H inch	J inch	W inch	B	
	inch	inch		inch	mm	inch	mm				inch	mm
27720-6-6	3/8	5/8x18	5/16	2.45	62	0.39	10	1/2	13/16	3/4	1.53	39

**WARNING:** This product can expose you to chemicals including Lead, which is known to the State of California to cause cancer and birth defects or other reproductive harm. For more information go to [www.p65warnings.ca.gov](http://www.p65warnings.ca.gov).

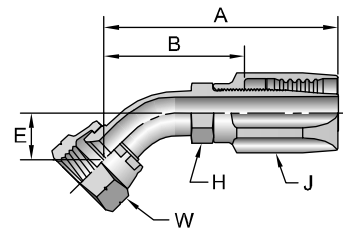

view on web page

## 27920

### Female SAE 45° - Swivel - 90° Elbow

# Part Number	Thread		Hose I.D. inch	A		E		H inch	J inch	W inch	B	
	inch	inch		inch	mm	inch	mm				inch	mm
27920-4-4	1/4	7/16x20	3/16	1.91	49	0.83	21	3/8	5/8	9/16	1.13	29
27920-6-6	3/8	5/8x18	5/16	2.33	59	0.85	22	1/2	13/16	3/4	1.41	36
27920-8-8	1/2	3/4x16	13/32	2.86	73	1.09	28	5/8	15/16	7/8	1.77	45
27920-10-10	5/8	7/8x14	1/2	3.20	81	1.24	31	3/4	1-1/8	1	1.98	50

**WARNING:** This product can expose you to chemicals including Lead, which is known to the State of California to cause cancer and birth defects or other reproductive harm. For more information go to [www.p65warnings.ca.gov](http://www.p65warnings.ca.gov).

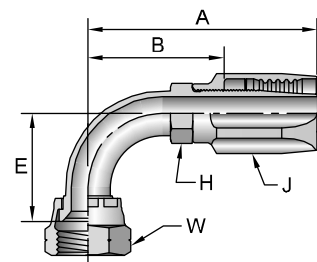

view on web page

Notch in nut signifies 45° flare.

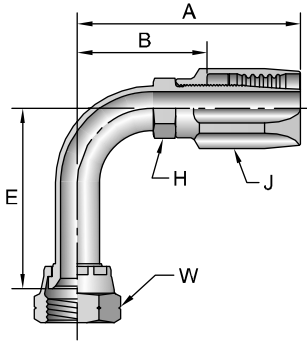

view on web page

### 28120 Female SAE 45° - Swivel - 90° Elbow - Long Drop

# Part Number	Thread inch	Hose I.D. inch	A inch mm		E inch mm		H inch	J inch	W inch	B inch mm	
28120-6-6	3/8 5/8x18	5/16	2.34	59	2.18	55	1/2	13/16	3/4	1.42	36

Notch in nut signifies 45° flare.

**WARNING:** This product can expose you to chemicals including Lead, which is known to the State of California to cause cancer and birth defects or other reproductive harm. For more information go to [www.p65warnings.ca.gov](http://www.p65warnings.ca.gov).

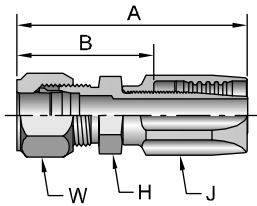

view on web page

### 21120 Male Ferulok Flareless - Rigid (24° Cone with Nut and Ferrule)

# Part Number	Thread inch	Hose I.D. inch	A inch mm		H inch	J inch	W inch	B inch mm	
21120-8-8	1/2 3/4x16	13/32	2.52	64	13/16	15/16	7/8	1.43	36

The Parker Ferrule-Fix fitting makes it possible to salvage the bent tube section from a hose assembly for quick, easy on the job repairs. For additional information see Ferrule-Fix installation instructions in the Technical Section.

**WARNING:** This product can expose you to chemicals including Lead, which is known to the State of California to cause cancer and birth defects or other reproductive harm. For more information go to [www.p65warnings.ca.gov](http://www.p65warnings.ca.gov).

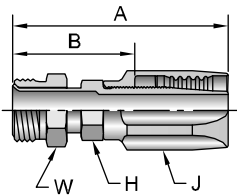

view on web page

### 22820 Male Inverted SAE 45° - Swivel

# Part Number	Thread inch	Hose I.D. inch	A inch mm		H inch	J inch	W inch	B inch mm	
22820-4-4	1/4 7/16x24	3/16	2.45	62	3/8	5/8	7/16	1.67	42
22820-5-5	5/16 1/2x20	1/4	2.70	69	7/16	11/16	1/2	1.87	47
22820-6-6	3/8 5/8x18	5/16	2.95	75	1/2	13/16	5/8	2.03	52
22820-8-8	1/2 3/4x18	13/32	3.36	85	5/8	15/16	3/4	2.27	58
22820-10-10	5/8 7/8x18	1/2	3.64	92	3/4	1-1/8	7/8	2.42	61

**WARNING:** This product can expose you to chemicals including Lead, which is known to the State of California to cause cancer and birth defects or other reproductive harm. For more information go to [www.p65warnings.ca.gov](http://www.p65warnings.ca.gov).

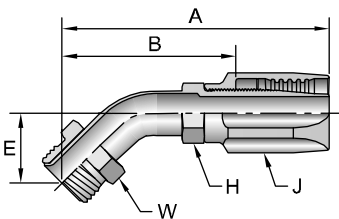

view on web page

### 26720 Male Inverted SAE 45° - Swivel - 45° Elbow

# Part Number	Thread inch	Hose I.D. inch	A inch mm		E inch mm		H inch	J inch	W inch	B inch mm	
26720-4-4	1/4 7/16x24	3/16	2.21	56	0.62	16	3/8	5/8	7/16	1.43	36
26720-5-5	5/16 1/2x20	1/4	2.44	62	0.70	18	7/16	11/16	1/2	1.61	41
26720-6-6	3/8 5/8x18	5/16	3.00	76	0.94	24	1/2	13/16	5/8	2.08	53
26720-8-8	1/2 3/4x18	13/32	3.51	89	1.09	28	5/8	15/16	3/4	2.42	61

**WARNING:** This product can expose you to chemicals including Lead, which is known to the State of California to cause cancer and birth defects or other reproductive harm. For more information go to [www.p65warnings.ca.gov](http://www.p65warnings.ca.gov).

## 26920

### Male Inverted SAE 45° - Swivel - 90° Elbow

# Part Number	Thread		Hose I.D. inch	A		E		H inch	J inch	W inch	B	
	inch	inch		inch	mm	inch	mm				inch	mm
26920-4-4	1/4	7/16x24	3/16	2.29	58	1.56	40	3/8	5/8	7/16	1.51	38
26920-5-5	5/16	1/2x20	1/4	2.55	65	1.65	42	7/16	11/16	1/2	1.72	44
26920-6-6	3/8	5/8x18	5/16	2.67	68	1.69	43	1/2	13/16	5/8	1.75	44
26920-8-8	1/2	3/4x18	13/32	3.09	78	1.88	48	5/8	15/16	3/4	2.00	51

**WARNING:** This product can expose you to chemicals including Lead, which is known to the State of California to cause cancer and birth defects or other reproductive harm. For more information go to [www.p65warnings.ca.gov](http://www.p65warnings.ca.gov).

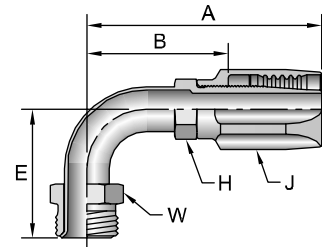

[view on web page](#)

## 23220

### Female PTT 30° - Swivel

# Part Number	Thread		Hose I.D. inch	A		H inch	J inch	W inch	B	
	inch	inch		inch	mm				inch	mm
23220-16-16	1	1-5/16x14	7/8	2.98	76	1-1/2	1-7/16	1-1/2	1.79	45

**WARNING:** This product can expose you to chemicals including Lead, which is known to the State of California to cause cancer and birth defects or other reproductive harm. For more information go to [www.p65warnings.ca.gov](http://www.p65warnings.ca.gov).

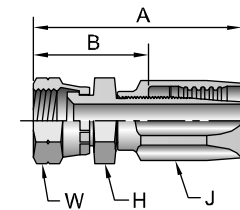

[view on web page](#)

## 26120

### Male SAE Compression Seat (without Nut or Sleeve)

# Part Number	Thread		Hose I.D. inch	A		H inch	J inch	B	
	inch	inch		inch	mm			inch	mm
26120-10-10	5/8	13/16x18	1/2	2.64	67	7/8	1-1/8	1.42	36

**WARNING:** This product can expose you to chemicals including Lead, which is known to the State of California to cause cancer and birth defects or other reproductive harm. For more information go to [www.p65warnings.ca.gov](http://www.p65warnings.ca.gov).

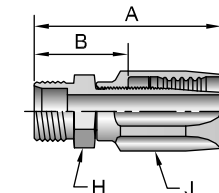

[view on web page](#)

## 21520

### SAE Code 61 Flange Head ISO 12151-3-S-L

# Part Number	Flange inch	Hose I.D. inch	A		F inch	H inch	J inch	B	
			inch	mm				inch	mm
21520-20-20	1-1/4	1-1/8	3.58	91	2	1-1/2	1-3/4	2.30	58

See Accessories Section for O-Rings and Flange Kits.

**WARNING:** This product can expose you to chemicals including Lead, which is known to the State of California to cause cancer and birth defects or other reproductive harm. For more information go to [www.p65warnings.ca.gov](http://www.p65warnings.ca.gov).

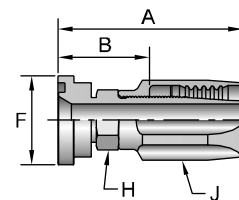

[view on web page](#)

### 21720 SAE Code 61 Flange Head - 45° Elbow

ISO 12151-3- E45S - L (1 Piece: ISO 12151-3- E45M - L)

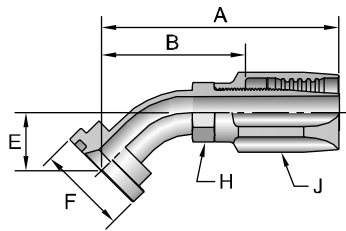

view on web page

#			A		E					B	
Part Number	Flange inch	Hose I.D. inch	inch	mm	inch	mm	inch	inch	inch	inch	mm
21720-20-20	1-1/4	1-1/8	4.10	104	1.12	28	2	1-1/2	1-3/4	2.82	72

**WARNING:** This product can expose you to chemicals including Lead, which is known to the State of California to cause cancer and birth defects or other reproductive harm. For more information go to [www.p65warnings.ca.gov](http://www.p65warnings.ca.gov).

### 21920 SAE Code 61 Flange Head - 90° Elbow

ISO 12151-3- E90S - L (1 Piece: ISO 12151-3- E90M - L)

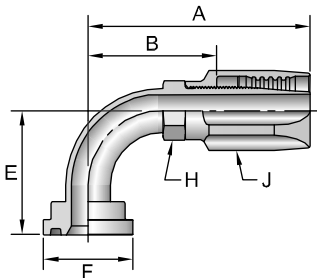

view on web page

#			A		E					B	
Part Number	Flange inch	Hose I.D. inch	inch	mm	inch	mm	inch	inch	inch	inch	mm
21920-32-32	2	1-13/16	5.44	138	3.19	81	2-13/16	2-1/4	2-1/2	3.70	94
21920-40-40	2-1/2	2-3/8	6.18	157	3.75	95	3-5/16	2-3/4	3-1/8	4.37	111

**WARNING:** This product can expose you to chemicals including Lead, which is known to the State of California to cause cancer and birth defects or other reproductive harm. For more information go to [www.p65warnings.ca.gov](http://www.p65warnings.ca.gov).

### 2JS20 Female Seal-Lok® - Swivel - Long

ISO 12151-1 - SWSB

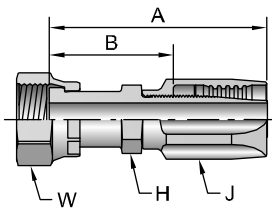

view on web page

#			A					B		
Part Number	Thread inch	Hose I.D. inch	inch	mm	inch	inch	inch	inch	mm	
2JS20-4-4	1/4	9/16x18	3/16	2.07	53	9/16	5/8	11/16	1.29	33
2JS20-6-6	3/8	11/16x16	5/16	2.36	60	1/2	13/16	13/16	1.44	37
2JS20-8-8	1/2	13/16x16	13/32	2.92	74	5/8	15/16	15/16	1.83	46
2JS20-10-10	5/8	1x14	1/2	3.15	80	3/4	1-1/8	1-1/8	1.93	49
2JS20-12-12	3/4	1-3/16x12	5/8	3.66	93	1-1/8	1-1/4	1-3/8	2.16	55

**WARNING:** This product can expose you to chemicals including Lead, which is known to the State of California to cause cancer and birth defects or other reproductive harm. For more information go to [www.p65warnings.ca.gov](http://www.p65warnings.ca.gov).

### 2J720 Female Seal-Lok® - Swivel - 45° Elbow

ISO 12151-1 - SWE45

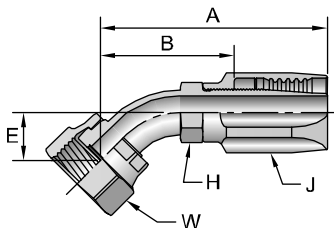

view on web page

#			A		E					B		
Part Number	Thread inch	Hose I.D. inch	inch	mm	inch	mm	inch	inch	inch	inch	mm	
2J720-4-4	1/4	9/16x18	3/16	2.24	57	0.41	10	7/16	5/8	11/16	1.46	37
2J720-6-6	3/8	11/16x16	5/16	2.52	64	0.43	11	1/2	13/16	13/16	1.60	41
2J720-8-8	1/2	13/16x16	13/32	3.19	81	0.59	15	5/8	15/16	15/16	2.10	53
2J720-10-10	5/8	1x14	1/2	3.46	88	0.65	17	3/4	1-1/8	1-1/8	2.24	57

**WARNING:** This product can expose you to chemicals including Lead, which is known to the State of California to cause cancer and birth defects or other reproductive harm. For more information go to [www.p65warnings.ca.gov](http://www.p65warnings.ca.gov).

See Accessories Section for O-Rings and Flange Kits.

## 2J920

### Female Seal-Lok® - Swivel 90° Elbow - Short Drop ISO 12151-1 - SWE90

# Part Number	Thread		Hose I.D. inch	A		E		H inch	J inch	W inch	B	
	inch	9/16x18		inch	inch	mm	inch				mm	inch
2J920-4-4	1/4	9/16x18	3/16	2.22	56	0.82	21	7/16	5/8	11/16	1.44	37
2J920-6-6	3/8	11/16x16	5/16	2.39	61	0.90	23	1/2	13/16	13/16	1.47	37
2J920-8-8	1/2	13/16x16	13/32	2.91	74	1.15	29	5/8	15/16	15/16	1.82	46
2J920-10-10	5/8	1x14	1/2	3.20	81	1.26	32	15/16	1-1/8	1-1/8	1.98	20
2J920-12-12	3/4	1-3/16x12	5/8	3.74	95	1.85	47	7/8	1-1/4	1-3/8	2.24	57

**WARNING:** This product can expose you to chemicals including Lead, which is known to the State of California to cause cancer and birth defects or other reproductive harm. For more information go to [www.p65warnings.ca.gov](http://www.p65warnings.ca.gov).

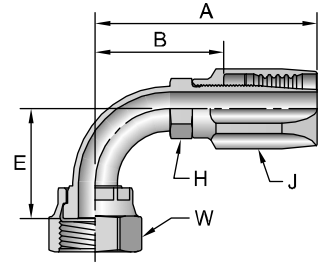

view on web page

## 2J120

### Female Seal-Lok® - Swivel - 90° Elbow - Long Drop ISO 12151-1 - SWEL90

# Part Number	Thread		Hose I.D. inch	A		E		H inch	J inch	W inch	B	
	inch	11/16x16		inch	inch	mm	inch				mm	inch
2J120-6-6	3/8	11/16x16	5/16	2.48	63	2.13	54	1/2	13/16	13/16	1.56	40
2J120-8-8	1/2	13/16x16	13/32	2.93	74	2.52	64	3/4	15/16	15/16	1.88	48

**WARNING:** This product can expose you to chemicals including Lead, which is known to the State of California to cause cancer and birth defects or other reproductive harm. For more information go to [www.p65warnings.ca.gov](http://www.p65warnings.ca.gov).

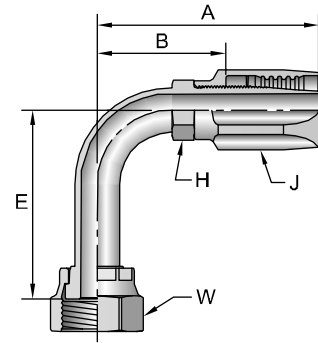

view on web page

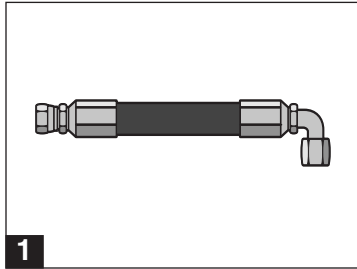

## 20 Series Hose Assembly Instructions

1. Identify over all length (OAL) of hose assembly and the cut off allowance (COA) length of fitting(s) on hose ends by use of the fitting data table. Properly measure, mark and cut hose to desired length using fine tooth hacksaw or cutoff machine. Care should be taken to ensure a square, clean cut is obtained.

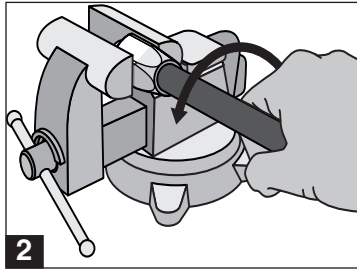

2. Air or solvent flush cut end of hose as necessary to produce a clean hose ID prior to assembly. Place socket in vice and screw in hose counter clockwise until hose bottoms. Back hose out 1/2 turn.

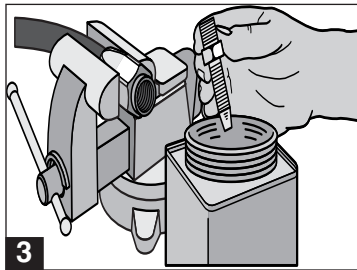

3. Oil inside of hose and nipple threads liberally with Hose-Oil. (See Section C). Do not oil hose cover.





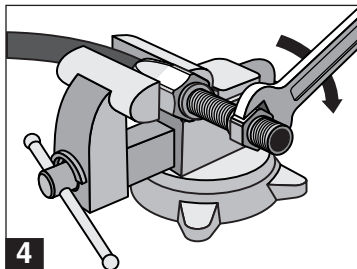





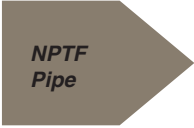
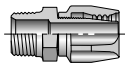

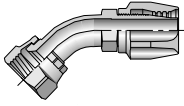
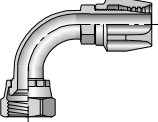

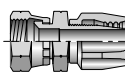
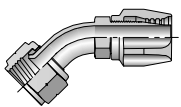
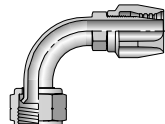
4. Screw nipple assembly into socket using a wrench on the nipple hex until the nipple hex shoulders against the socket. A 1/32" to 1/16" gap between the nipple hex and socket is allowed for displacement angle adjustment when two elbow fittings are used.

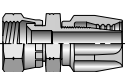
**Inspection.** Examine hose assembly internally for cut or bulged tube, obstructions and cleanliness. Clean ID of hose as necessary. Swivel nuts should turn freely. Check the layline of the hose to be sure the assembly is not twisted. Cap the ends of the assembly to keep clean.

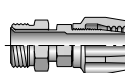
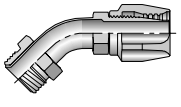
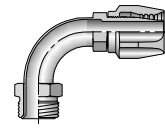

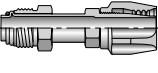
**Special Instructions for stainless steel fittings.** When assembling fittings made with 316 stainless steel, lubricate the threads of both the socket and nipple with Accrolube High Efficiency Lubricant (see Section C) or equivalent metal assembly lubricant.

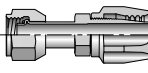
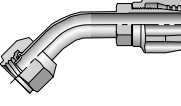
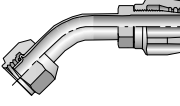
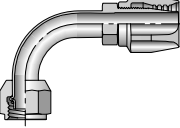
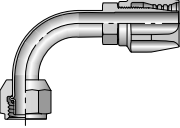
**Note:** Disassemble in reverse order.

 <p><b>NPTF Pipe</b></p>	<p>20121 B-156</p>  <p><i>Male - Rigid</i></p>	 <p><b>JIC 37°</b></p>	<p>20621 B-156</p>  <p><i>Female - Swivel</i></p>	<p>23721 B-156</p>  <p><i>Female - Swivel 45° Elbow - Short</i></p>	<p>23921 B-157</p>  <p><i>Female - Swivel 90° Elbow - Short</i></p>
 <p><b>SAE 45°</b></p>	<p>20821 B-157</p>  <p><i>Female - Swivel</i></p>	<p>27721 B-157</p>  <p><i>Female - Swivel 45° Elbow</i></p>	<p>27921 B-158</p>  <p><i>Female - Swivel 90° Elbow</i></p>	 <p><b>PTT 30°</b></p>	<p>23221 B-158</p>  <p><i>Female - Swivel</i></p>
 <p><b>Inverted Flare</b></p>	<p>22821 B-158</p>  <p><i>Male - Swivel</i></p>	<p>26721 B-159</p>  <p><i>Male - Swivel 45° Elbow</i></p>	<p>26921 B-159</p>  <p><i>Male - Swivel 90° Elbow</i></p>	 <p><b>Tube-O</b></p>	<p>2S521 B-159</p>  <p><i>Male - Swivel Short</i></p>
<p>25M21 B-160</p>  <p><i>Male - Swivel 90° Elbow - Long</i></p>	<p>25S21 B-160</p>  <p><i>Female - Swivel Short</i></p>	<p>25H21 B-160</p>  <p><i>Female - Swivel 45° Elbow - Short</i></p>	<p>25N21 B-161</p>  <p><i>Female - Swivel 45° Elbow - Long</i></p>	<p>25T21 B-161</p>  <p><i>Female - Swivel 90° Elbow - Short</i></p>	<p>25L21 B-161</p>  <p><i>Female - Swivel 90° Elbow - Long</i></p>
 <p><b>Assembly Instructions</b></p>	<p>21 Series B-162</p> <p><i>Assembly Instructions</i></p>				

A

B

C

D

E

## 20121 Male NPTF Pipe - Rigid

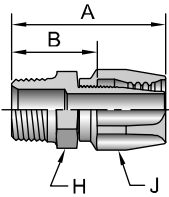

view on web page

# Part Number	Thread inch	Hose I.D. inch	A		H	J	B	
			inch	mm	inch	inch	inch	mm
20121-2-4	1/8x27	3/16	1.55	39	7/16	9/16	0.88	22
20121-4-4	1/4x18	3/16	1.77	45	9/16	9/16	1.10	28
20121-4-5	1/4x18	1/4	1.79	45	9/16	5/8	1.05	27
20121-4-6	1/4x18	5/16	1.92	49	9/16	3/4	1.14	29
20121-6-6	3/8x18	5/16	1.95	50	11/16	3/4	1.17	30
20121-6-8	3/8x18	13/32	2.10	53	11/16	7/8	1.18	30
20121-8-8	1/2x14	13/32	2.34	59	7/8	7/8	1.42	36
20121-8-10	1/2x14	1/2	2.44	62	7/8	1-1/16	1.44	37
20121-12-12	3/4x14	5/8	2.58	66	1-1/8	1-1/4	1.50	38
20121-12-16	3/4x14	7/8	2.50	64	1-1/4	1-7/16	1.51	38
20121-16-16	1x11-1/2	7/8	2.69	68	1-3/8	1-7/16	1.70	43

**WARNING:** This product can expose you to chemicals including Lead, which is known to the State of California to cause cancer and birth defects or other reproductive harm. For more information go to [www.p65warnings.ca.gov](http://www.p65warnings.ca.gov).

## 20621 Female JIC 37° - Swivel

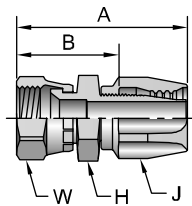

view on web page

# Part Number	Thread inch	Hose I.D. inch	A		H	J	W	B		
			inch	mm	inch	inch	inch	inch	mm	
20621-4-4	1/4	7/16x20	3/16	1.83	46	9/16	9/16	9/16	1.16	29
20621-5-5	5/16	1/2x20	1/4	1.92	49	5/8	5/8	5/8	1.18	30
20621-6-6	3/8	9/16x18	5/16	2.09	53	11/16	3/4	11/16	1.31	33
20621-8-8	1/2	3/4x16	13/32	2.46	62	7/8	7/8	7/8	1.54	39
20621-8-10	1/2	3/4x16	1/2	2.56	65	1	1-1/16	7/8	1.56	40
20621-10-10	5/8	7/8x14	1/2	2.65	67	1	1-1/16	1	1.65	42
20621-12-12	3/4	1-1/16x12	5/8	2.85	72	1-1/4	1-1/4	1-1/4	1.77	45
20621-16-16	1	1-5/16x12	7/8	2.94	75	1-1/2	1-7/16	1-1/2	1.95	50
20621-20-20	1-1/4	1-5/8x12	1-1/8	3.16	80	2	1-3/4	2	2.12	54

**WARNING:** This product can expose you to chemicals including Lead, which is known to the State of California to cause cancer and birth defects or other reproductive harm. For more information go to [www.p65warnings.ca.gov](http://www.p65warnings.ca.gov).

## 23721 Female JIC 37° - Swivel - 45° Elbow - Short Drop

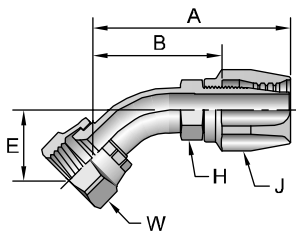

view on web page

# Part Number	Thread inch	Hose I.D. inch	A		E		H	J	W	B		
			inch	mm	inch	mm	inch	inch	inch	inch	mm	
23721-4-4	1/4	7/16x20	3/16	2.11	54	0.39	10	3/8	9/16	9/16	1.43	36
23721-6-6	3/8	9/16x18	5/16	2.26	57	0.40	10	1/2	3/4	11/16	1.48	38
23721-8-8	1/2	3/4x16	13/32	2.79	71	0.59	15	11/16	7/8	7/8	1.87	47
23721-10-10	5/8	7/8x14	1/2	2.97	75	0.63	16	7/8	1-1/16	1	1.97	50
23721-12-12	3/4	1-1/16x12	5/8	3.30	84	0.83	21	7/8	1-1/4	1-1/4	2.22	56
23721-16-16	1	1-5/16x12	7/8	3.44	87	0.90	23	1-1/8	1-7/16	1-1/2	2.45	62

**WARNING:** This product can expose you to chemicals including Lead, which is known to the State of California to cause cancer and birth defects or other reproductive harm. For more information go to [www.p65warnings.ca.gov](http://www.p65warnings.ca.gov).



# 23921

## Female JIC 37° - Swivel - 90° Elbow - Short Drop

# Part Number	Thread		Hose I.D. inch	A		E		H	J	W	B	
	inch	inch		inch	mm	inch	mm	inch	inch	inch	inch	mm
23921-4-4	1/4	7/16x20	3/16	1.88	48	0.83	21	3/8	9/16	9/16	1.20	30
23921-5-5	5/16	1/2x20	1/4	2.07	53	0.83	21	1/2	5/8	5/8	1.33	34
23921-6-6	3/8	9/16x18	5/16	2.15	55	0.85	22	1/2	3/4	11/16	1.37	35
23921-8-8	1/2	3/4x16	13/32	2.49	63	1.14	29	11/16	7/8	7/8	1.57	40
23921-10-10	5/8	7/8x14	1/2	2.78	71	1.26	32	7/8	1-1/16	1	1.78	45
23921-12-12	3/4	1-1/16x12	5/8	2.88	73	1.89	48	7/8	1-1/4	1-1/4	1.80	46
23921-16-16	1	1-5/16x12	7/8	3.40	86	2.14	54	1-1/8	1-7/16	1-1/2	2.41	61
23921-20-20	1-1/4	1-5/8x12	1-1/8	3.64	92	2.59	66	1-3/8	1-3/4	2	2.60	66

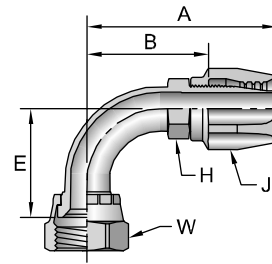

view on web page

**WARNING:** This product can expose you to chemicals including Lead, which is known to the State of California to cause cancer and birth defects or other reproductive harm. For more information go to [www.p65warnings.ca.gov](http://www.p65warnings.ca.gov).

# 20821

## Female SAE 45° - Swivel

# Part Number	Thread		Hose I.D. inch	A		H	J	W	B	
	inch	inch		inch	mm	inch	inch	inch	inch	mm
20821-4-4	1/4	7/16x20	3/16	1.83	46	9/16	9/16	9/16	1.16	29
20821-5-5	5/16	1/2x20	1/4	1.91	49	5/8	5/8	5/8	1.17	30
20821-6-6	3/8	5/8x18	5/16	2.12	54	3/4	3/4	3/4	1.34	34
20821-8-8	1/2	3/4x16	13/32	2.46	62	7/8	7/8	7/8	1.54	39
20821-10-10	5/8	7/8x14	1/2	2.65	67	1	1-1/16	1	1.65	42
20821-12-12	3/4	1-1/16x14	5/8	2.85	72	1-1/4	1-1/4	1-1/4	1.77	45

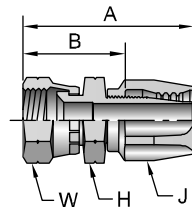

view on web page

**WARNING:** This product can expose you to chemicals including Lead, which is known to the State of California to cause cancer and birth defects or other reproductive harm. For more information go to [www.p65warnings.ca.gov](http://www.p65warnings.ca.gov).

# 27721

## Female SAE 45° - Swivel - 45° Elbow

# Part Number	Thread		Hose I.D. inch	A		E		H	J	W	B	
	inch	inch		inch	mm	inch	mm	inch	inch	inch	inch	mm
27721-6-6	3/8	5/8x18	5/16	2.26	57	0.40	10	1/2	3/4	3/4	1.48	38

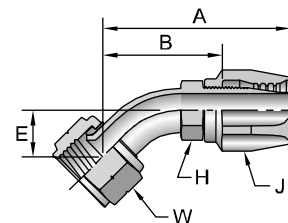

view on web page

**WARNING:** This product can expose you to chemicals including Lead, which is known to the State of California to cause cancer and birth defects or other reproductive harm. For more information go to [www.p65warnings.ca.gov](http://www.p65warnings.ca.gov).

Notch in nut signifies 45° flare.

A

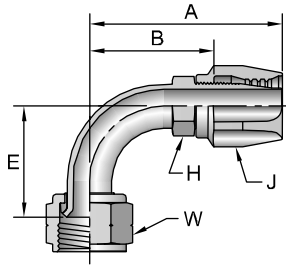

view on web page

## 27921

### Female SAE 45° - Swivel - 90° Elbow

#	Thread	Hose I.D.	A		E		H	J	W	B	
Part Number	inch	inch	inch	mm	inch	mm	inch	inch	inch	inch	mm
27921-6-6	3/8 5/8x18	5/16	2.15	55	0.85	22	1/2	3/4	3/4	1.37	35

Notch in nut signifies 45° flare.

**WARNING:** This product can expose you to chemicals including Lead, which is known to the State of California to cause cancer and birth defects or other reproductive harm. For more information go to [www.p65warnings.ca.gov](http://www.p65warnings.ca.gov).

B

## 23221

### Female PTT 30° - Swivel

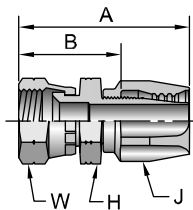

view on web page

#	Thread	Hose I.D.	A		H	J	W	B	
Part Number	inch	inch	inch	mm	inch	inch	inch	inch	mm
23221-16-16	1 1-5/16x14	7/8	2.70	69	1-1/2	1-7/16	1-1/2	1.71	43

**WARNING:** This product can expose you to chemicals including Lead, which is known to the State of California to cause cancer and birth defects or other reproductive harm. For more information go to [www.p65warnings.ca.gov](http://www.p65warnings.ca.gov).

C

## 22821

### Male Inverted SAE 45° - Swivel

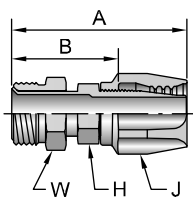

view on web page

#	Thread	Hose I.D.	A		H	J	W	B	
Part Number	inch	inch	inch	mm	inch	inch	inch	inch	mm
22821-4-4	1/4 7/16x24	3/16	2.36	60	3/8	9/16	7/16	1.68	43
22821-5-5	5/16 1/2x20	1/4	2.34	59	7/16	5/8	1/2	1.60	41
22821-5-6	5/16 1/2x20	5/16	2.47	63	1/2	3/4	1/2	1.69	43
22821-6-6	3/8 5/8x18	5/16	2.45	62	1/2	3/4	5/8	1.67	42
22821-8-8	1/2 3/4x18	13/32	2.84	72	5/8	7/8	3/4	1.92	49

**WARNING:** This product can expose you to chemicals including Lead, which is known to the State of California to cause cancer and birth defects or other reproductive harm. For more information go to [www.p65warnings.ca.gov](http://www.p65warnings.ca.gov).

D

E

Notch in nut signifies 45° flare.

## 26721

### Male Inverted SAE 45° - Swivel - 45° Elbow

# Part Number	Thread		Hose I.D. inch	A		E		H	J	W	B	
	inch	5/8x18		inch	inch	mm	inch	mm	inch	inch	inch	inch
26721-6-6	3/8	5/8x18	5/16	2.73	69	0.94	24	1/2	3/4	5/8	1.95	50

**WARNING:** This product can expose you to chemicals including Lead, which is known to the State of California to cause cancer and birth defects or other reproductive harm. For more information go to [www.p65warnings.ca.gov](http://www.p65warnings.ca.gov).

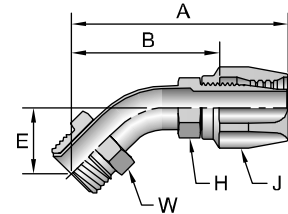

[view on web page](#)

## 26921

### Male Inverted SAE 45° - Swivel - 90° Elbow

# Part Number	Thread		Hose I.D. inch	A		E		H	J	W	B	
	inch	1/2x20		inch	inch	mm	inch	mm	inch	inch	inch	inch
26921-5-5	5/16	1/2x20	1/4	2.25	57	1.65	42	7/16	5/8	1/2	1.51	38
26921-6-6	3/8	5/8x18	5/16	2.37	60	1.63	41	1/2	3/4	5/8	1.59	40
26921-8-8	1/2	3/4x18	13/32	2.63	67	1.78	45	5/8	7/8	3/4	1.71	43

**WARNING:** This product can expose you to chemicals including Lead, which is known to the State of California to cause cancer and birth defects or other reproductive harm. For more information go to [www.p65warnings.ca.gov](http://www.p65warnings.ca.gov).

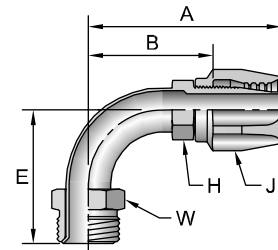

[view on web page](#)

## 2S521

### Male Tube-O - Swivel - Short Pilot

# Part Number	Thread		Hose I.D. inch	A		D		H	J	W	B	
	inch	5/8x18		inch	inch	mm	inch	mm	inch	inch	inch	inch
2S521-6-6	3/8	5/8x18	5/16	2.64	67	0.18	4,7	1/2	3/4	5/8	1.86	47

**WARNING:** This product can expose you to chemicals including Lead, which is known to the State of California to cause cancer and birth defects or other reproductive harm. For more information go to [www.p65warnings.ca.gov](http://www.p65warnings.ca.gov).

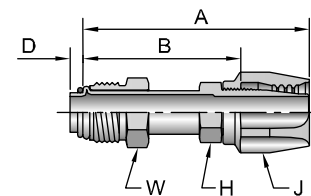

A

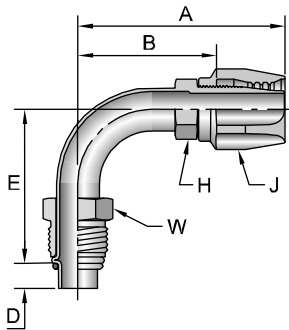

### 25M21

#### Male Tube-O - Swivel - 90° Elbow - Long Pilot

# Part Number	Thread		Hose I.D. inch	A		D		E		H inch	J inch	W inch	B	
	inch	inch		inch	mm	inch	mm	inch	mm				inch	mm
25M21-8-8	1/2	3/4x18	13/32	2.49	63	0.38	9,8	2.12	54	5/8	7/8	3/4	1.57	40
25M21-10-10	5/8	7/8x18	1/2	3.27	83	0.38	9,8	1.95	50	3/4	1-1/16	7/8	2.27	58

**WARNING:** This product can expose you to chemicals including Lead, which is known to the State of California to cause cancer and birth defects or other reproductive harm. For more information go to [www.p65warnings.ca.gov](http://www.p65warnings.ca.gov).

B

### 25S21

#### Female Tube-O - Swivel - Short Pilot

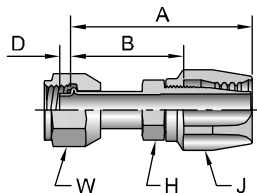

# Part Number	Thread		Hose I.D. inch	A		D		H inch	J inch	W inch	B	
	inch	inch		inch	mm	inch	mm				inch	mm
25S21-6-6	3/8	5/8x18	5/16	2.66	68	0.18	4,7	1/2	3/4	3/4	1.88	48
25S21-8-8	1/2	3/4x16	13/32	2.86	73	0.18	4,7	5/8	7/8	7/8	1.94	49

**WARNING:** This product can expose you to chemicals including Lead, which is known to the State of California to cause cancer and birth defects or other reproductive harm. For more information go to [www.p65warnings.ca.gov](http://www.p65warnings.ca.gov).

C

### 25H21

#### Female Tube-O - Swivel - 45° Elbow - Short Pilot

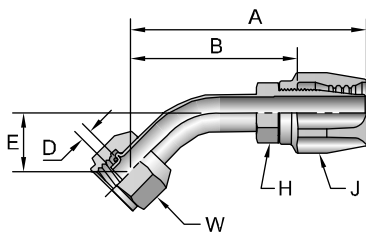

# Part Number	Thread		Hose I.D. inch	A		D		E		H inch	J inch	W inch	B	
	inch	inch		inch	mm	inch	mm	inch	mm				inch	mm
25H21-8-8	1/2	3/4x16	13/32	2.74	70	0.18	4,7	0.60	15	5/8	7/8	7/8	1.82	46

**WARNING:** This product can expose you to chemicals including Lead, which is known to the State of California to cause cancer and birth defects or other reproductive harm. For more information go to [www.p65warnings.ca.gov](http://www.p65warnings.ca.gov).

D

E

## 25N21

### Female Tube-O - Swivel - 45° Elbow - Long Pilot

# Part Number	Thread inch	Hose I.D. inch	A		D		E		H	J	W	B	
			inch	mm	inch	mm	inch	mm	inch	inch	inch	inch	mm
25N21-8-8	1/2 3/4x16	13/32	3.24	82	0.38	9,8	0.98	25	5/8	7/8	7/8	2.32	59

**WARNING:** This product can expose you to chemicals including Lead, which is known to the State of California to cause cancer and birth defects or other reproductive harm. For more information go to [www.p65warnings.ca.gov](http://www.p65warnings.ca.gov).

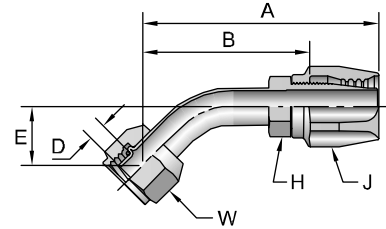

## 25T21

### Female Tube-O - Swivel - 90° Elbow - Short Pilot

# Part Number	Thread inch	Hose I.D. inch	A		D		E		H	J	W	B	
			inch	mm	inch	mm	inch	mm	inch	inch	inch	inch	mm
25T21-6-6	3/8 5/8x18	5/16	2.35	60	0.18	4,7	1.21	31	1/2	3/4	3/4	1.57	40
25T21-8-8	1/2 3/4x16	13/32	2.83	72	0.18	4,7	1.31	33	5/8	7/8	7/8	1.91	49
25T21-10-10	5/8 7/8x14	1/2	3.33	85	0.18	4,7	1.50	38	3/4	1-1/16	1-1/16	2.33	59

**WARNING:** This product can expose you to chemicals including Lead, which is known to the State of California to cause cancer and birth defects or other reproductive harm. For more information go to [www.p65warnings.ca.gov](http://www.p65warnings.ca.gov).

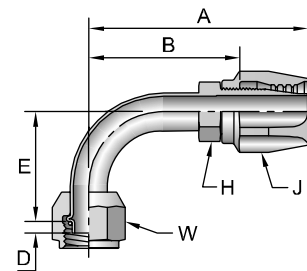

## 25L21

### Female Tube-O - Swivel - 90° Elbow - Long Pilot

# Part Number	Thread inch	Hose I.D. inch	A		D		E		H	J	W	B	
			inch	mm	inch	mm	inch	mm	inch	inch	inch	inch	mm
25L21-6-6	3/8 5/8x18	5/16	2.28	58	0.28	7,1	1.43	36	1/2	3/4	3/4	1.50	38
25L21-8-8	1/2 3/4x16	13/32	2.50	64	0.38	9,8	1.46	37	5/8	7/8	7/8	1.58	40
25L21-10-10	5/8 7/8x14	1/2	2.83	72	0.38	9,8	1.75	44	3/4	1-1/16	1-1/16	1.83	46

**WARNING:** This product can expose you to chemicals including Lead, which is known to the State of California to cause cancer and birth defects or other reproductive harm. For more information go to [www.p65warnings.ca.gov](http://www.p65warnings.ca.gov).

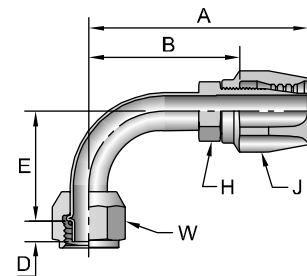

## 21 Series

### Hose Assembly Instructions

1. Identify over all length (OAL) of hose assembly and the cut off allowance (COA) length of fitting(s) on hose ends by use of the fitting data table. Properly measure, mark and cut hose to desired length using fine tooth hacksaw or a cutoff machine. Care should be taken to ensure a square, clean cut is obtained.
2. Air or solvent flush cut end of hose as necessary to produce a clean hose ID prior to assembly. Place socket in vice and screw in hose counter clockwise until hose bottoms. Back hose out ½ turn.
3. Oil inside of hose and nipple threads liberally with Hose-Oil. (See Section C). Do not oil hose cover.
4. Screw nipple assembly into socket using a wrench on the nipple hex until the nipple hex shoulders against the socket. A 1/32" to 1/16" gap between the nipple hex and socket is allowed for displacement angle adjustment when elbow fittings are used.

**Inspection.** Examine hose assembly internally for cut or bulged tube, obstructions and cleanliness. Clean ID of hose as necessary. Swivel nuts should turn freely. Check the layline of the hose to be sure the assembly is not twisted. Cap the ends of the assembly to keep clean.

**Special instructions for stainless steel fittings.** When assembling fittings made with 316 stainless steel, lubricate the threads of both the socket and nipple with Accrolube High Efficiency Lubricant (see Section C) or equivalent metal assembly lubricant.

**Note:** Disassemble in reverse order.

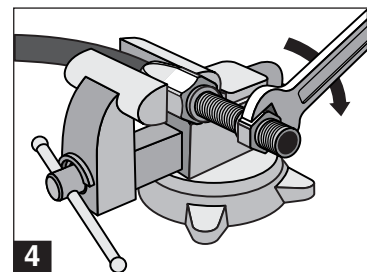
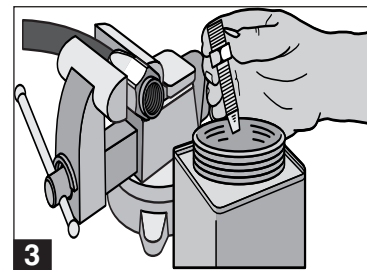
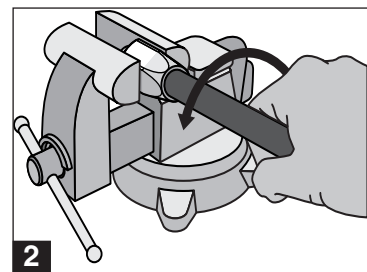
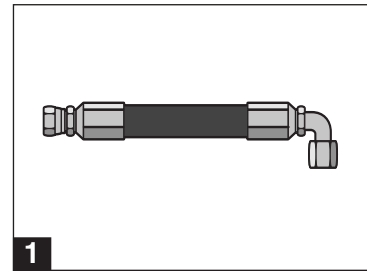







A

B

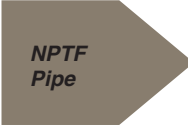
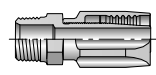
C

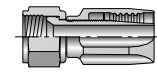
D

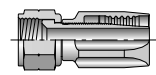
E

 <p><b>NPTF Pipe</b></p>	<p>20122      B-164</p>  <p><i>Male - Rigid</i></p>	 <p><b>JIC 37°</b></p>	<p>20622      B-164</p>  <p><i>Female - Swivel</i></p>	 <p><b>SAE 45°</b></p>	<p>20822      B-164</p>  <p><i>Female - Swivel</i></p>
 <p><b>Assembly Instructions</b></p>	<p>22 Series      B-165</p> <p><i>Assembly Instructions</i></p>				



## 20122

### Male NPTF Pipe - Rigid

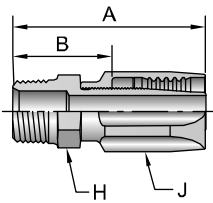

view on web page

# Part Number	Thread inch	Hose I.D. inch	A		H inch	J inch	B		Additional Material Brass (B)
			inch	mm			inch	mm	
20122-4-6	1/4x18	5/16	2.11	54	9/16	13/16	1.19	30	•

**WARNING:** This product can expose you to chemicals including Lead, which is known to the State of California to cause cancer and birth defects or other reproductive harm. For more information go to [www.p65warnings.ca.gov](http://www.p65warnings.ca.gov).

## 20622

### Female JIC 37° - Swivel

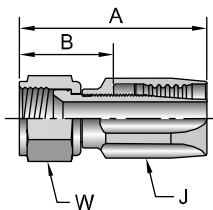

view on web page

# Part Number	Thread inch		Hose I.D. inch	A		J inch	W inch	B		Additional Material Brass (B)
	inch	mm		inch	mm			inch	mm	
20622-4-4	1/4	7/16x20	3/16	1.74	44	5/8	9/16	0.96	24	•
20622-6-6	3/8	9/16x18	5/16	2.05	52	13/16	11/16	1.13	29	•
20622-8-8	1/2	3/4x16	13/32	2.55	65	15/16	7/8	1.46	37	•
20622-10-10	5/8	7/8x14	1/2	2.80	71	1-1/8	1	1.58	40	•
20622-12-12	3/4	1-1/16x12	5/8	3.15	80	1-1/4	1-1/8	1.65	42	•
20622-16-16	1	1-5/16x12	7/8	2.84	72	1-7/16	1-1/2	1.65	42	•
20622-20-20	1-1/4	1-5/8x12	1-1/8	3.00	76	1-3/4	2	1.72	44	•
20622-24-24	1-1/2	1-7/8x12	1-3/8	3.30	84	2	2-1/4	1.93	49	•
20622-32-32	2	2-1/2x12	1-13/16	4.05	103	2-1/2	2-7/8	2.31	59	•

**WARNING:** This product can expose you to chemicals including Lead, which is known to the State of California to cause cancer and birth defects or other reproductive harm. For more information go to [www.p65warnings.ca.gov](http://www.p65warnings.ca.gov).

## 20822

### Female SAE 45° - Swivel

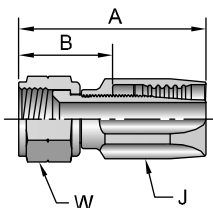

view on web page

# Part Number	Thread inch		Hose I.D. inch	A		J inch	W inch	B		Additional Material Brass (B)
	inch	mm		inch	mm			inch	mm	
20822-4-4	1/4	7/16x20	3/16	1.74	44	5/8	9/16	0.96	24	•
20822-5-5	5/16	1/2x20	1/4	1.91	49	11/16	5/8	1.08	27	•
20822-6-6	3/8	5/8x18	5/16	2.08	53	13/16	3/4	1.16	29	•
20822-8-8	1/2	3/4x16	13/32	2.45	62	15/16	7/8	1.36	35	•
20822-10-10	5/8	7/8x14	1/2	2.80	71	1-1/8	1	1.58	40	•

Notch in nut for SAE (45°) flare.

**WARNING:** This product can expose you to chemicals including Lead, which is known to the State of California to cause cancer and birth defects or other reproductive harm. For more information go to [www.p65warnings.ca.gov](http://www.p65warnings.ca.gov).



## 22 Series

### Mandrel Assembly Instructions

1. Identify over all length (OAL) of hose assembly and the cut off allowance (COA) length of fitting(s) on hose ends by use of the fitting data table. Properly measure, mark and cut hose to desired length using fine tooth hacksaw or a cutoff machine. Care should be taken to ensure a square, clean cut is obtained. Air or solvent flush cut end of hose as necessary to produce a clean hose ID prior to assembly. Place socket in vice and screw in hose counter clockwise until hose bottoms. Back hose out  $\frac{1}{2}$  turn.
2. When assembling male pipe ends, slide nipple onto mandrel.
3. When assembling swivel ends, slide swivel nut over nipple. Slide nut and nipple onto mandrel. Screw mandrel threads into nipple and wrench tighten.
4. Oil inside of hose and nipple threads liberally with Hose-Oil. (See Section C). **Do not oil hose cover.**
5. Push nipple into socket.
  - Male ends: Thread nipple in until it bottoms against socket.
  - Swivel ends: Thread nipple into socket using hex on assembly mandrel. Leave clearance of approximately  $\frac{1}{32}$ " (.784mm) between nut and socket to allow nut to swivel. **Remove mandrel.**

**Note:** Disassemble in reverse order.

**Caution: Do Not Attempt to Assemble These Fittings to the Hose Without Using a Mandrel.**

**Inspection.** Examine hose assembly internally for cut or bulged tube, obstructions and cleanliness. Clean ID of hose as necessary. Swivel nuts should turn freely. Check the layline of the hose to be sure the assembly is not twisted. Cap the ends of the assembly to keep clean.

**Special Instructions for Refrigerant Hose.** Oil inside of hose and nipple threads liberally with the same oil used in refrigeration system. **Do not oil hose cover.** Do not allow hose to contact any petroleum base fluids.

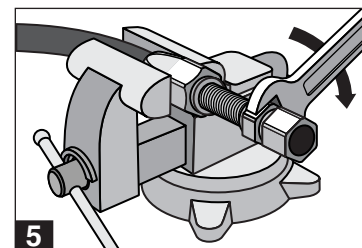
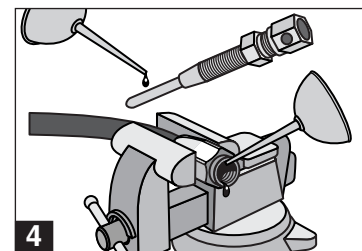
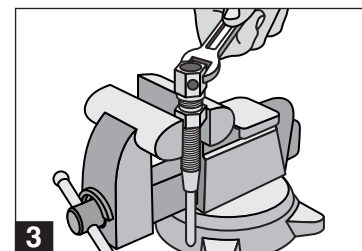
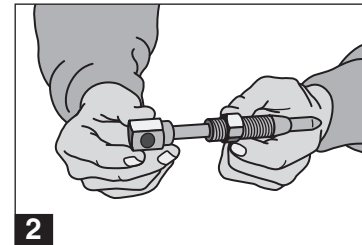
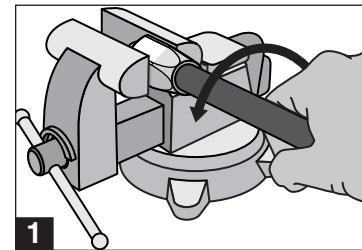

A

B





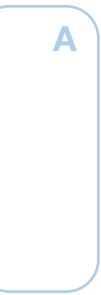

C

D

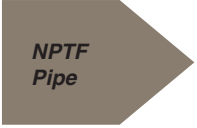
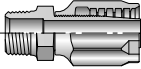
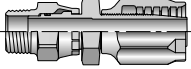
E

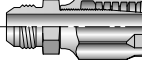
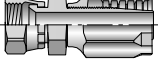
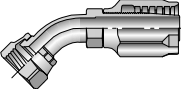
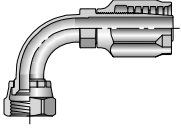
*Notes*

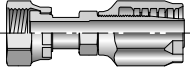
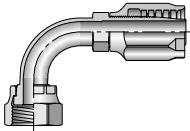

 <p><b>NPTF Pipe</b></p>	<p>20130      B-168</p>  <p><i>Male - Rigid</i></p>	<p>21330      B-168</p>  <p><i>Male - Swivel</i></p>	 <p><b>JIC 37°</b></p>	<p>20330      B-169</p>  <p><i>Male - Rigid</i></p>	<p>20630      B-169</p>  <p><i>Female - Swivel</i></p>
<p>23730      B-170</p>  <p><i>Female - Swivel 45° Elbow - Short</i></p>	<p>23930      B-170</p>  <p><i>Female - Swivel 90° Elbow - Short</i></p>	 <p><b>Seal-Lok® O-Ring Face Seal</b></p>	<p>2JS30      B-171</p>  <p><i>Female - Swivel Long</i></p>	<p>2J930      B-171</p>  <p><i>Female - Swivel 90° Elbow - Short</i></p>	 <p><b>Assembly Instructions</b></p>
<p>30 Series      B-172</p> <p><i>Assembly Instructions</i></p>					

A

B

C

D

E

## 20130 Male NPTF Pipe - Rigid

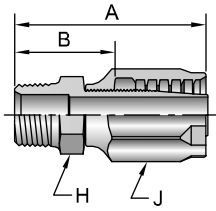

view on web page

# Part Number	Thread inch	Hose I.D. inch	A		H	J	B	
			inch	mm	inch	inch	inch	mm
20130-2-4	1/8x27	1/4	2.19	56	9/16	3/4	1.23	31
20130-4-4	1/4x18	1/4	2.38	60	9/16	3/4	1.42	36
20130-6-6	3/8x18	3/8	2.58	66	3/4	15/16	1.44	37
20130-8-8	1/2x14	1/2	3.11	79	7/8	1-1/16	1.77	45
20130-12-12	3/4x14	3/4	3.20	81	1-1/8	1-3/8	1.77	45
20130-16-16	1x11-1/2	1	3.74	95	1-3/8	1-3/4	2.03	52

**WARNING:** This product can expose you to chemicals including Lead, which is known to the State of California to cause cancer and birth defects or other reproductive harm. For more information go to [www.p65warnings.ca.gov](http://www.p65warnings.ca.gov).

## 21330 Male NPTF Pipe - Swivel

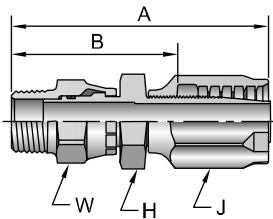

view on web page

# Part Number	Thread inch	Hose I.D. inch	A		H	J	W	B	
			inch	mm	inch	inch	inch	inch	mm
21330-6-6	3/8x18	3/8	3.67	93	7/8	15/16	3/4	2.53	64
21330-8-8	1/2x14	1/2	4.20	107	1	1-1/16	7/8	2.86	73

**WARNING:** This product can expose you to chemicals including Lead, which is known to the State of California to cause cancer and birth defects or other reproductive harm. For more information go to [www.p65warnings.ca.gov](http://www.p65warnings.ca.gov).

O-Rings are not compatible with Phosphate Ester fluids.

## 20330 Male JIC 37° - Rigid

# Part Number	Thread		Hose I.D. inch	A		H inch	J inch	B	
	inch	7/16x20		inch	mm			inch	mm
20330-4-4	1/4	7/16x20	1/4	2.37	60	9/16	3/4	1.41	36
20330-6-6	3/8	9/16x18	3/8	2.58	66	3/4	15/16	1.44	37
20330-8-8	1/2	3/4x16	1/2	3.02	77	7/8	1-1/16	1.68	43
20330-10-10	5/8	7/8x14	5/8	3.29	84	15/16	1-1/4	1.83	46
20330-12-12	3/4	1-1/16x12	3/4	3.31	84	1-1/8	1-3/8	1.88	48

**WARNING:** This product can expose you to chemicals including Lead, which is known to the State of California to cause cancer and birth defects or other reproductive harm. For more information go to [www.p65warnings.ca.gov](http://www.p65warnings.ca.gov).

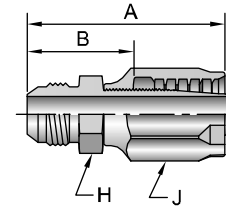

view on web page

## 20630 Female JIC 37° - Swivel

# Part Number	Thread		Hose I.D. inch	A		H inch	J inch	W inch	B		Additional Material Stainless Steel (C)
	inch	1/2x20		inch	mm				inch	mm	
20630-4-4	1/4	7/16x20	1/4	2.45	62	9/16	3/4	9/16	1.49	38	•
20630-5-4	5/16	1/2x20	1/4	2.52	64	5/8	3/4	5/8	1.56	40	
20630-6-4	3/8	9/16x18	1/4	2.54	65	11/16	3/4	11/16	1.58	40	
20630-6-6	3/8	9/16x18	3/8	2.74	70	11/16	15/16	11/16	1.60	41	•
20630-8-8	1/2	3/4x16	1/2	3.20	81	7/8	1-1/16	7/8	1.86	47	•
20630-10-8	5/8	7/8x14	1/2	3.30	84	1	1-1/16	1	1.96	50	
20630-10-10	5/8	7/8x14	5/8	3.54	90	1	1-1/4	1	2.08	53	
20630-16-16	1	1-5/16x12	1	3.94	100	1-1/2	1-3/4	1-1/2	2.23	57	
20630-20-20	1-1/4	1-5/8x12	1-1/4	4.96	126	2	2-1/4	2	2.83	72	

**WARNING:** This product can expose you to chemicals including Lead, which is known to the State of California to cause cancer and birth defects or other reproductive harm. For more information go to [www.p65warnings.ca.gov](http://www.p65warnings.ca.gov).

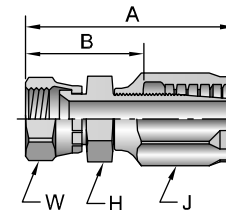

view on web page

## 23730

### Female JIC 37° - Swivel - 45° Elbow - Short Drop

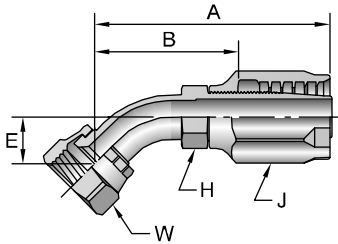

view on web page

# Part Number	Thread		Hose I.D.		A		E		H	J	W	B	
	inch		inch	mm	inch	mm	inch	mm	inch	inch	inch	inch	mm
23730-12-12	3/4	1-1/16x12	3/4	3.93 100	0.79	20	15/16	1-3/8	1-1/4	2.50	64		

**WARNING:** This product can expose you to chemicals including Lead, which is known to the State of California to cause cancer and birth defects or other reproductive harm. For more information go to [www.p65warnings.ca.gov](http://www.p65warnings.ca.gov).

## 23930

### Female JIC 37° - Swivel - 90° Elbow - Short Drop

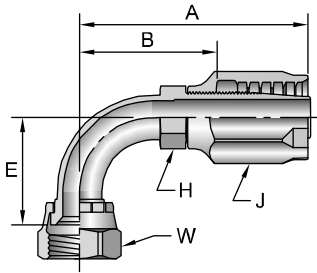

view on web page

# Part Number	Thread		Hose I.D.		A		E		H	J	W	B	
	inch		inch	mm	inch	mm	inch	mm	inch	inch	inch	inch	mm
23930-6-6	3/8	9/16x18	3/8	2.95 75	0.91	23	9/16	15/16	11/16	1.81	46		
23930-8-8	1/2	3/4x16	1/2	3.40 86	1.14	29	11/16	1-1/16	7/8	2.06	52		

**WARNING:** This product can expose you to chemicals including Lead, which is known to the State of California to cause cancer and birth defects or other reproductive harm. For more information go to [www.p65warnings.ca.gov](http://www.p65warnings.ca.gov).

## 2JS30

### Female Seal-Lok® - Swivel - Long ISO 12151-1 - SWSB

# Part Number	Thread		Hose I.D. inch	A		H	J	W	B	
	inch	inch		inch	mm	inch	inch	inch	inch	mm
2JS30-4-4	1/4	9/16x18	1/4	2.62	67	9/16	3/4	11/16	1.66	42
2JS30-6-6	3/8	11/16x16	3/8	2.89	73	9/16	15/16	13/16	1.75	44
2JS30-8-8	1/2	13/16x16	1/2	3.32	84	11/16	1-1/16	15/16	1.98	50
2JS30-12-12	3/4	1-3/16x12	3/4	3.65	93	15/16	1-3/8	1-3/8	2.22	56

**WARNING:** This product can expose you to chemicals including Lead, which is known to the State of California to cause cancer and birth defects or other reproductive harm. For more information go to [www.p65warnings.ca.gov](http://www.p65warnings.ca.gov).

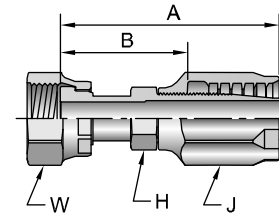

[view on web page](#)

## 2J930

### Female Seal-Lok® - Swivel - 90° Elbow - Short Drop ISO 12151-1 - SWES90

# Part Number	Thread		Hose I.D. inch	A		E		H	J	W	B	
	inch	inch		inch	mm	inch	mm	inch	inch	inch	inch	mm
2J930-4-4	1/4	9/16x18	1/4	2.83	72	0.82	21	7/16	3/4	11/16	1.87	47
2J930-8-8	1/2	13/16x16	1/2	3.40	86	1.14	29	3/4	1-1/16	15/16	2.06	52

**WARNING:** This product can expose you to chemicals including Lead, which is known to the State of California to cause cancer and birth defects or other reproductive harm. For more information go to [www.p65warnings.ca.gov](http://www.p65warnings.ca.gov).

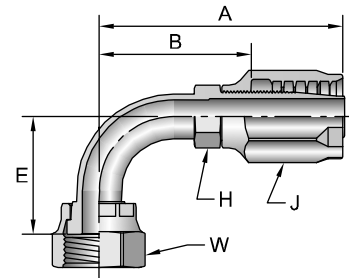

[view on web page](#)

A

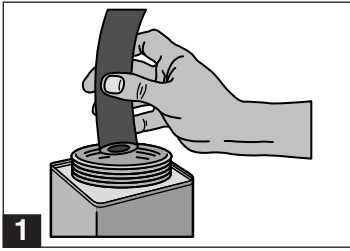

1

B

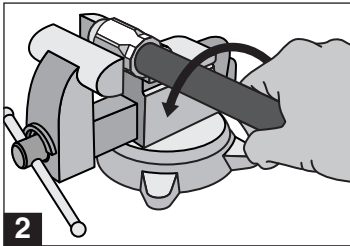

2

C

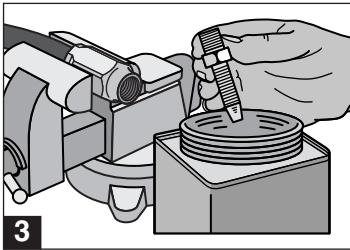

3

D

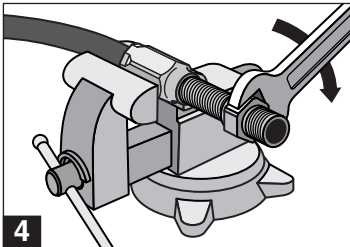

4

E







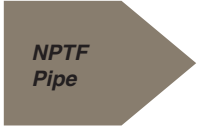
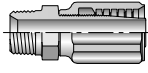
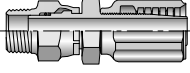

## 30 Series

### Hose Assembly Instructions

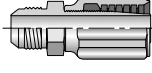
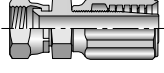
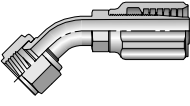
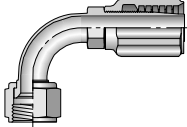
1. Identify over all length (OAL) of hose assembly and the cut off allowance (COA) length of fitting(s) on hose ends by use of the fitting data table. Properly measure, mark and cut hose to desired length using fine tooth hacksaw or a cutoff machine. Dip hose end into Hose-Oil (See Section C) or heavy oil.
2. Place socket in vice and screw in hose counter-clockwise until hose bottoms. Back hose out 1/2 turn.
3. Dip hose end of nipple into Hose-Oil or other heavy oil up to the hex. When assembling fittings of 316 stainless steel lubricate the threads of both the socket and nipple with Dow Corning Molykote G-n or equivalent metal assembly lubricant.
4. Screw nipple assembly into socket using wrench on nipple hex until nipple hex shoulders against socket.

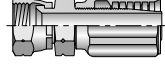
**Note:** Disassemble in reverse order.

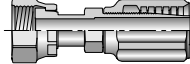

 <p><b>NPTF Pipe</b></p>	<p>20142 B-174</p>  <p><i>Male - Rigid</i></p>	<p>21342 B-174</p>  <p><i>Male - Swivel</i></p>	 <p><b>JIC 37°</b></p>	<p>20342 B-174</p>  <p><i>Male - Rigid</i></p>	<p>20642 B-175</p>  <p><i>Female - Swivel</i></p>
<p>23742 B-175</p>  <p><i>Female - Swivel 45° Elbow - Short</i></p>	<p>23942 B-175</p>  <p><i>Female - Swivel 90° Elbow - Short</i></p>	 <p><b>SAE</b></p>	<p>20842 B-176</p>  <p><i>Female - Swivel</i></p>	 <p><b>Seal-Lok® O-Ring Face Seal</b></p>	<p>2JS42 B-176</p>  <p><i>Female - Swivel Long</i></p>
 <p><b>Assembly Instructions</b></p>	<p>42 Series B-177</p> <p><i>Assembly Instructions</i></p>				

A

B

C

D

E

## 20142

### Male NPTF Pipe - Rigid

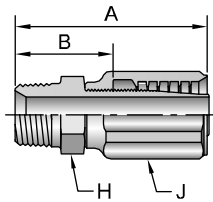

view on web page

# Part Number	Thread inch	Hose I.D. inch	A		H	J	B	
			inch	mm	inch	inch	inch	mm
20142-2-4	1/8x27	1/4	2.17	55	9/16	11/16	1.25	32
20142-4-4	1/4x18	1/4	2.36	60	9/16	11/16	1.44	37
20142-4-5	1/4x18	5/16	2.39	61	9/16	13/16	1.44	37
20142-4-6	1/4x18	3/8	2.60	66	11/16	7/8	1.45	37
20142-6-6	3/8x18	3/8	2.60	66	3/4	7/8	1.45	37
20142-8-8	1/2x14	1/2	3.02	77	7/8	1	1.69	43
20142-12-12	3/4x14	3/4	3.23	82	1-1/8	1-3/8	1.75	44

**WARNING:** This product can expose you to chemicals including Lead, which is known to the State of California to cause cancer and birth defects or other reproductive harm. For more information go to [www.p65warnings.ca.gov](http://www.p65warnings.ca.gov).

## 21342

### Male NPTF Pipe - Swivel

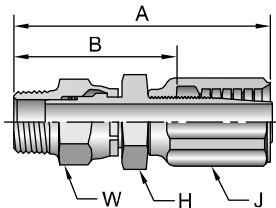

view on web page

# Part Number	Thread inch	Hose I.D. inch	A		H	J	W	B	
			inch	mm	inch	inch	inch	inch	mm
21342-4-4	1/4x18	1/4	3.40	86	9/16	11/16	5/8	2.48	63
21342-6-6	3/8x18	3/8	3.69	94	7/8	7/8	3/4	2.54	65

**WARNING:** This product can expose you to chemicals including Lead, which is known to the State of California to cause cancer and birth defects or other reproductive harm. For more information go to [www.p65warnings.ca.gov](http://www.p65warnings.ca.gov).

## 20342

### Male JIC 37° - Rigid

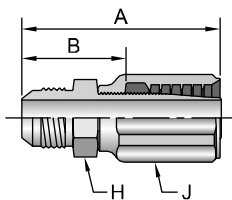

view on web page

# Part Number	Thread inch		Hose I.D. inch	A		H	J	B	
	1/4	7/16x20		inch	mm	inch	inch	inch	mm
20342-4-4	1/4	7/16x20	1/4	2.35	60	9/16	11/16	1.43	36
20342-6-6	3/8	9/16x18	3/8	2.60	66	3/4	7/8	1.45	37
20342-8-8	1/2	3/4x16	1/2	2.93	74	7/8	1	1.60	41

**WARNING:** This product can expose you to chemicals including Lead, which is known to the State of California to cause cancer and birth defects or other reproductive harm. For more information go to [www.p65warnings.ca.gov](http://www.p65warnings.ca.gov).

## 20642

### Female JIC 37° - Swivel

# Part Number	Thread		Hose I.D. inch	A		H inch	J inch	W inch	B		Additional Material Stainless Steel (C)
	inch	inch		inch	mm				inch	mm	
20642-4-3	1/4	7/16x20	3/16	2.34	59	9/16	5/8	9/16	1.56	40	
20642-4-4	1/4	7/16x20	1/4	2.43	62	9/16	11/16	9/16	1.51	38	
20642-6-4	3/8	9/16x18	1/4	2.52	64	11/16	11/16	11/16	1.60	41	
20642-6-6	3/8	9/16x18	3/8	2.76	70	11/16	7/8	11/16	1.61	41	•
20642-8-6	1/2	3/4x16	3/8	2.88	73	7/8	7/8	7/8	1.73	44	•
20642-8-8	1/2	3/4x16	1/2	3.11	79	7/8	1	7/8	1.78	45	•
20642-10-10	5/8	7/8x14	5/8	3.49	89	1	1-1/8	1	2.07	53	
20642-12-12	3/4	1-1/16x12	3/4	3.53	90	1-1/4	1-3/8	1-1/4	2.05	52	
20642-16-16	1	1-5/16x12	1	3.81	97	1-1/2	1-5/8	1-1/2	2.27	58	

**WARNING:** This product can expose you to chemicals including Lead, which is known to the State of California to cause cancer and birth defects or other reproductive harm. For more information go to [www.p65warnings.ca.gov](http://www.p65warnings.ca.gov).

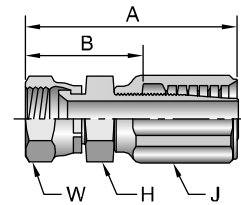

view on web page

## 23742

### Female JIC 37° - Swivel - 45° Elbow - Short Drop

# Part Number	Thread		Hose I.D. inch	A		E		H inch	J inch	W inch	B	
	inch	inch		inch	mm	inch	mm				inch	mm
23742-6-6	3/8	9/16x18	3/8	3.03	77	0.39	10	9/16	7/8	11/16	1.88	48

**WARNING:** This product can expose you to chemicals including Lead, which is known to the State of California to cause cancer and birth defects or other reproductive harm. For more information go to [www.p65warnings.ca.gov](http://www.p65warnings.ca.gov).

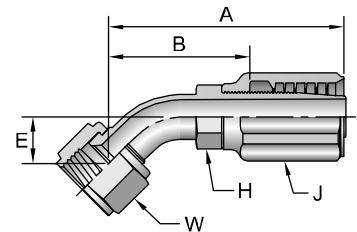

view on web page

## 23942

### Female JIC 37° - Swivel - 90° Elbow - Short Drop

# Part Number	Thread		Hose I.D. inch	A		E		H inch	J inch	W inch	B	
	inch	inch		inch	mm	inch	mm				inch	mm
23942-4-4	1/4	7/16x20	1/4	2.50	64	0.83	21	7/16	11/16	9/16	1.58	40
23942-6-6	3/8	9/16x18	3/8	2.93	74	0.85	22	9/16	7/8	11/16	1.78	45
23942-8-8	1/2	3/4x16	1/2	3.22	82	1.09	28	11/16	1	7/8	1.90	48

**WARNING:** This product can expose you to chemicals including Lead, which is known to the State of California to cause cancer and birth defects or other reproductive harm. For more information go to [www.p65warnings.ca.gov](http://www.p65warnings.ca.gov).

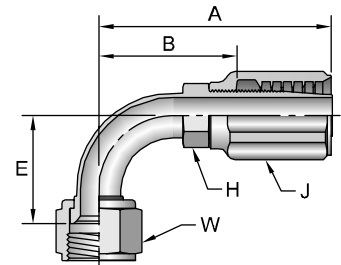

view on web page

## 20842

### Female SAE 45° - Swivel

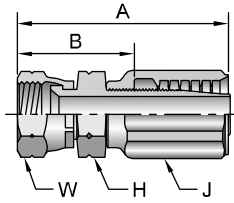

[view on web page](#)

# Part Number	Thread inch	Hose I.D. inch	A		H	J	W	B	
			inch	mm	inch	inch	inch	inch	mm
20842-6-6	3/8 5/8x18	3/8	2.82	72	3/4	7/8	3/4	1.67	42

Notch on nut signifies SAE 45° flare.

**WARNING:** This product can expose you to chemicals including Lead, which is known to the State of California to cause cancer and birth defects or other reproductive harm. For more information go to [www.p65warnings.ca.gov](http://www.p65warnings.ca.gov).

## 2JS42

### Female Seal-Lok® - Swivel - Long

ISO - 12151-1 - SWSB

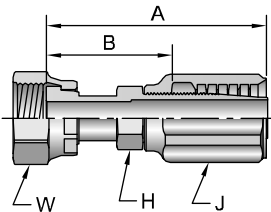

[view on web page](#)

# Part Number	Thread inch	Hose I.D. inch	A		H	J	W	B	
			inch	mm	inch	inch	inch	inch	mm
2JS42-6-6	3/8 11/16x16	3/8	2.91	74	9/16	7/8	13/16	1.76	45
2JS42-8-8	1/2 13/16x16	1/2	3.23	82	11/16	1	15/16	1.90	48

**WARNING:** This product can expose you to chemicals including Lead, which is known to the State of California to cause cancer and birth defects or other reproductive harm. For more information go to [www.p65warnings.ca.gov](http://www.p65warnings.ca.gov).

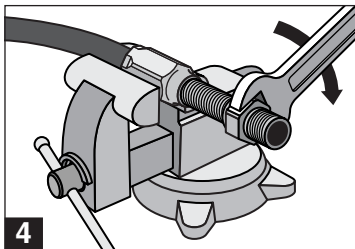
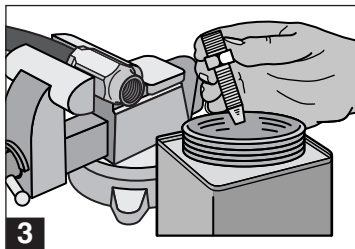
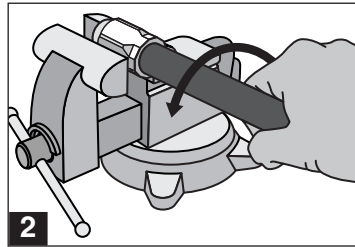
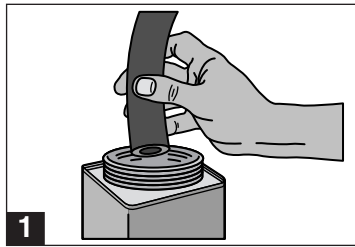









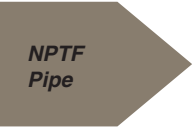
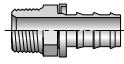
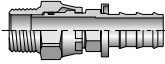
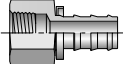
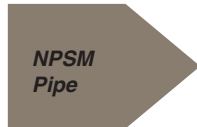
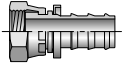



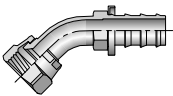
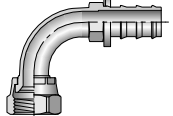
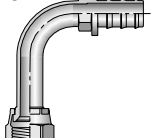

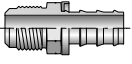

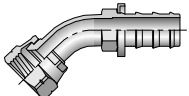
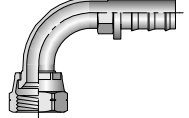

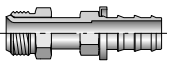
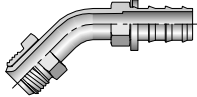
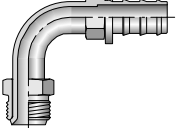

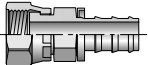
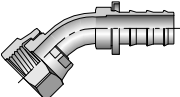
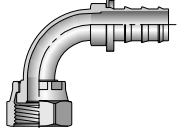

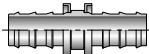

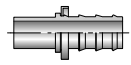
## 42 Series Hose Assembly Instructions

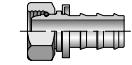
1. Identify over all length (OAL) of hose assembly and the cut off allowance (COA) length of fitting(s) on hose ends by use of the fitting data table. Properly measure, mark and cut hose to desired length using fine tooth hacksaw or a cutoff machine. Dip hose end into Hose-Oil (See Section C) or heavy oil.
2. Place socket in vice and screw in hose counter-clockwise until hose bottoms. Back hose out 1/2 turn.
3. Dip hose end of nipple into Hose-Oil or other heavy oil up to the hex. When assembling fittings of 316 stainless steel lubricate the threads of both the socket and nipple with Dow Corning Molykote G-n or equivalent metal assembly lubricant.
4. Screw assembly into socket using wrench on nipple hex until nipple hex shoulders against socket.

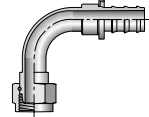
**Note:** Disassemble in reverse order.

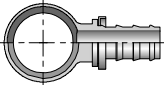
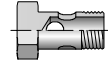

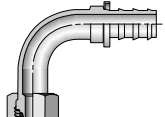
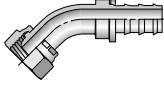
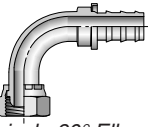
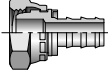
A		30182 B-179  Male - Rigid	31382 B-179  Male - Swivel	30282 B-180  Female - Rigid		37G82 B-180  Female - Swivel Gasket Joint
		30382 B-180  Male - Rigid	30682 B-181  Female - Swivel	33782 B-181  Female - Swivel 45° Elbow - Short	33982 B-182  Female - Swivel 90° Elbow - Short	34182 B-182  Female - Swivel 90° Elbow - Long
B		30482 B-182  Male - Rigid	30882 B-183  Female - Swivel	37782 B-183  Female - Swivel 45° Elbow	37982 B-183  Female - Swivel 90° Elbow	
	32882 B-184  Male - Swivel	36782 B-184  Male - Swivel 45° Elbow	36982 B-184  Male - Swivel 90° Elbow	32982 B-185  Female - Rigid		3JC82 B-185  Female - Swivel Short
C	3J782 B-186  Female - Swivel 45° Elbow	3J982 B-186  Female - Swivel 90° Elbow - Short		38282 B-187  Push-Lok Union		3D082 B-187  Male - Rigid
	31D82 B-187  Male Standpipe Rigid		39282 B-188  Female - Swivel	3D982 B-188  Male - Rigid	3B282 B-188  Female - Swivel 90° Elbow	
D	34982 B-189  Metric - Banjo	AM B-189  Banjo Bolt		3CA82 B-190  Swivel - 24° Cone	3CF82 B-190  Swivel - 90° Elbow - 24° Cone	3C482 B-190  Swivel - 45° Elbow - Ball Nose
	3C582 B-191  Swivel - 90° Elbow - Ball Nose	3C382 B-191  Swivel - Ball Nose	82 Series B-192  Assembly Instructions			
E						

## 30182 Male NPTF Pipe - Rigid

# Part Number	Thread inch	Hose I.D. inch	A		H	B		Additional Material	
			inch	mm	inch	inch	mm	Brass (B)	Stainless Steel (C)
30182-2-4	1/8x27	1/4	1.39	35	7/16	0.64	16	•	•
30182-4-4	1/4x18	1/4	1.57	40	9/16	0.82	21	•	•
30182-4-6	1/4x18	3/8	1.78	45	9/16	0.88	22	•	•
30182-4-8	1/4x18	1/2	1.93	49	5/8	0.88	22	•	•
30182-6-6	3/8x18	3/8	1.78	45	11/16	0.88	22	•	•
30182-6-8	3/8x18	1/2	1.93	49	11/16	0.88	22	•	•
30182-8-8	1/2x14	1/2	2.18	55	7/8	1.13	29	•	•
30182-8-10	1/2x14	5/8	2.58	66	7/8	1.13	29	•	•
30182-12-10	3/4x14	5/8	2.61	66	1-1/16	1.16	29	•	•
30182-12-12	3/4x14	3/4	2.61	66	1-1/16	1.16	29	•	•

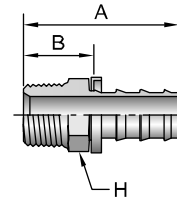

view on web page

**WARNING:** This product can expose you to chemicals including Lead, which is known to the State of California to cause cancer and birth defects or other reproductive harm. For more information go to [www.p65warnings.ca.gov](http://www.p65warnings.ca.gov).

## 31382 Male NPTF Pipe - Swivel

# Part Number	Thread inch	Hose I.D. inch	A		W	B		Additional Material Brass (B)
			inch	mm	inch	inch	mm	
31382-4-4	1/4x18	1/4	1.60	41	9/16	0.85	22	
31382-6-6	3/8x18	3/8	1.79	45	11/16	0.89	23	
31382-8-8	1/2x14	1/2	2.20	56	7/8	1.15	29	
31382-8-10	1/2x14	5/8	3.50	90	7/8	2.05	52	•
31382-12-12	3/4x14	3/4	3.70	94	1-1/4	2.25	57	

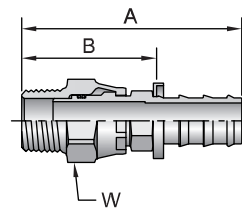

view on web page

O-Ring not compatible with Phosphate Ester fluids.

**WARNING:** This product can expose you to chemicals including Lead, which is known to the State of California to cause cancer and birth defects or other reproductive harm. For more information go to [www.p65warnings.ca.gov](http://www.p65warnings.ca.gov).

### 30282 Female NPTF Pipe - Rigid

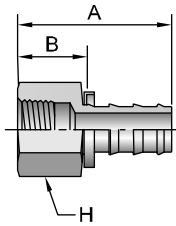

view on web page

# Part Number	Thread inch	Hose I.D. inch	A		H inch	B		Additional Material Brass (B)
			inch	mm		inch	mm	
30282-4-4	1/4x18	1/4	1.56	40	3/4	0.81	21	•
30282-6-6	3/8x18	3/8	1.82	46	7/8	0.92	23	•

**WARNING:** This product can expose you to chemicals including Lead, which is known to the State of California to cause cancer and birth defects or other reproductive harm. For more information go to [www.p65warnings.ca.gov](http://www.p65warnings.ca.gov).

### 37G82 Female NPSM Pipe - Gasket Joint - Swivel

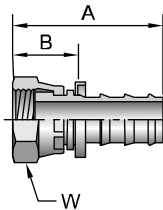

view on web page

# Part Number	Gasket	Thread inch	Hose I.D. inch	A		W inch	B	
				inch	mm		inch	mm
37G82-4-4	07G-4	1/4x18	1/4	1.55	39	11/16	0.80	20
37G82-4-6	07G-4	1/4x18	3/8	1.70	43	11/16	0.80	20
37G82-6-6	07G-6	3/8x18	3/8	1.75	44	7/8	0.85	22
37G82-8-8	07G-8	1/2x14	1/2	2.07	53	1	1.02	26
37G82-8-10	07G-8	1/2x14	5/8	2.47	63	1	1.02	26
37G82-12-12	07G-12	3/4x14	3/4	2.54	65	1-1/4	1.09	28

Textile gasket included with fitting.

**WARNING:** This product can expose you to chemicals including Lead, which is known to the State of California to cause cancer and birth defects or other reproductive harm. For more information go to [www.p65warnings.ca.gov](http://www.p65warnings.ca.gov).

### 30382 Male JIC 37° - Rigid

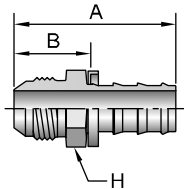

view on web page

# Part Number	Thread inch		Hose I.D. inch	A		H inch	B		Additional Material Brass (B)
	inch	mm		inch	mm		inch	mm	
30382-4-4	1/4	7/16x20	1/4	1.56	40	1/2	0.81	21	
30382-6-6	3/8	9/16x18	3/8	1.78	45	5/8	0.88	22	•
30382-8-8	1/2	3/4x16	1/2	2.06	52	3/4	1.01	26	
30382-12-12	3/4	1-1/16x12	3/4	2.72	69	1-1/8	1.27	32	

**WARNING:** This product can expose you to chemicals including Lead, which is known to the State of California to cause cancer and birth defects or other reproductive harm. For more information go to [www.p65warnings.ca.gov](http://www.p65warnings.ca.gov).



# 30682

## Female JIC 37° - Swivel

# Part Number	Thread		Hose I.D. inch	A		W inch	B		Additional Material	
	inch			inch	mm		inch	mm	Brass (B)	Stainless Steel (C)
30682-4-4	1/4	7/16x20	1/4	1.52	39	9/16	0.77	20	•	•
30682-5-4	5/16	1/2x20	1/4	1.58	40	5/8	0.83	21	•	•
30682-6-6	3/8	9/16x18	3/8	1.75	44	11/16	0.85	22	•	•
30682-6-8	3/8	9/16x18	1/2	1.90	48	11/16	0.85	22	•	•
30682-8-6	1/2	3/4x16	3/8	1.87	47	7/8	0.97	25	•	•
30682-8-8	1/2	3/4x16	1/2	2.02	51	7/8	0.97	25	•	•
30682-10-10	5/8	7/8x14	5/8	2.54	65	1	1.09	28	•	•
30682-12-12	3/4	1-1/16x12	3/4	2.65	67	1-1/4	1.20	30	•	•

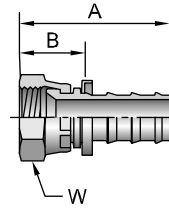

view on web page

**WARNING:** For Carbon Steel Fittings Only: This product can expose you to chemicals including Lead, which is known to the State of California to cause cancer and birth defects or other reproductive harm. For more information go to [www.p65warnings.ca.gov](http://www.p65warnings.ca.gov).

# 33782

## Female JIC 37° - Swivel - 45° Elbow - Short Drop

# Part Number	Thread		Hose I.D. inch	A		E		H inch	W inch	B	
	inch			inch	mm	inch	mm			inch	mm
33782-4-4	1/4	7/16x20	1/4	1.74	44	0.39	10	7/16	9/16	0.99	25
33782-6-6	3/8	9/16x18	3/8	1.99	51	0.43	11	1/2	11/16	1.09	28
33782-8-8	1/2	3/4x16	1/2	2.58	66	0.55	14	5/8	7/8	1.53	39
33782-10-10	5/8	7/8x14	5/8	3.03	77	0.65	17	3/4	1	1.58	40

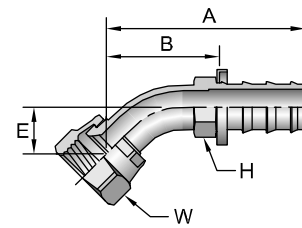

view on web page

**WARNING:** This product can expose you to chemicals including Lead, which is known to the State of California to cause cancer and birth defects or other reproductive harm. For more information go to [www.p65warnings.ca.gov](http://www.p65warnings.ca.gov).

### 33982 Female JIC 37° - Swivel - 90° Elbow - Short Drop

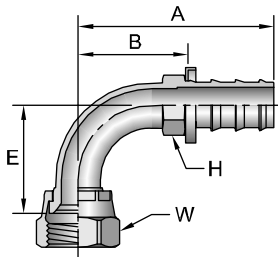

view on web page

# Part Number	Thread		Hose I.D. inch	A		E		H inch	W inch	B	
	inch	inch		inch	mm	inch	mm			inch	mm
33982-4-4	1/4	7/16x20	1/4	1.55	39	0.83	21	---	9/16	0.80	20
33982-6-6	3/8	9/16x18	3/8	1.86	47	0.91	23	---	11/16	0.95	24
33982-8-8	1/2	3/4x16	1/2	2.16	55	1.14	29	5/8	7/8	1.28	32
33982-10-10	5/8	7/8x14	5/8	2.76	70	1.26	32	3/4	1	1.31	33
33982-12-12	3/4	1-1/16x12	3/4	3.27	83	1.89	48	7/8	1-1/4	1.82	46

**WARNING:** This product can expose you to chemicals including Lead, which is known to the State of California to cause cancer and birth defects or other reproductive harm. For more information go to [www.p65warnings.ca.gov](http://www.p65warnings.ca.gov).

### 34182 Female JIC 37° - Swivel - 90° Elbow - Long Drop

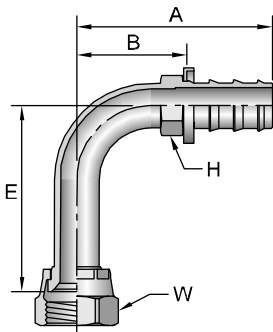

view on web page

# Part Number	Thread		Hose I.D. inch	A		E		H inch	W inch	B	
	inch	inch		inch	mm	inch	mm			inch	mm
34182-4-4	1/4	7/16x20	1/4	1.79	45	1.80	46	7/16	9/16	1.04	26
34182-6-6	3/8	9/16x18	3/8	1.97	50	2.18	55	1/2	11/16	1.07	27

**WARNING:** This product can expose you to chemicals including Lead, which is known to the State of California to cause cancer and birth defects or other reproductive harm. For more information go to [www.p65warnings.ca.gov](http://www.p65warnings.ca.gov).

### 30482 Male SAE 45° - Rigid

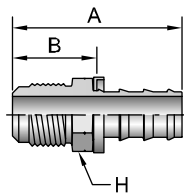

view on web page

# Part Number	Thread		Hose I.D. inch	A		H inch	B	
	inch	inch		inch	mm		inch	mm
30482-4-4B	1/4	7/16x20	1/4	1.51	38	7/16	0.76	19
30482-5-4B	5/16	1/2x20	1/4	1.61	41	9/16	0.86	22
30482-6-6B	3/8	5/8x18	3/8	1.84	47	5/8	0.94	24
30482-8-8B	1/2	3/4x16	1/2	2.15	55	3/4	1.10	28

**WARNING:** This product can expose you to chemicals including Lead, which is known to the State of California to cause cancer and birth defects or other reproductive harm. For more information go to [www.p65warnings.ca.gov](http://www.p65warnings.ca.gov).

Notch in nut signifies 45° flare.

### 30882 Female SAE 45° - Swivel

# Part Number	Thread		Hose I.D. inch	A		W inch	B		Additional Material Brass (B)
	inch	7/16x20		inch	mm		inch	mm	
30882-4-4	1/4	7/16x20	1/4	1.52	39	9/16	0.77	20	•
30882-6-6	3/8	5/8x18	3/8	1.81	46	3/4	0.91	23	•
30882-8-8	1/2	3/4x16	1/2	2.02	51	7/8	0.97	25	•
30882-10-10	5/8	7/8x14	5/8	2.54	65	1	1.09	28	•
30882-12-12	3/4	1-1/16x14	3/4	2.65	67	1-1/4	1.20	30	•

**WARNING:** This product can expose you to chemicals including Lead, which is known to the State of California to cause cancer and birth defects or other reproductive harm. For more information go to [www.p65warnings.ca.gov](http://www.p65warnings.ca.gov).

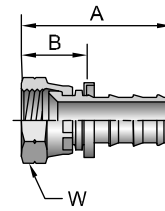

[view on web page](#)

### 37782 Female SAE 45° - Swivel - 45° Elbow

# Part Number	Thread		Hose I.D. inch	A		E		H	W	B	
	inch	5/8x18		inch	mm	inch	mm	inch	inch	inch	mm
37782-6-6	3/8	5/8x18	3/8	2.08	53	0.39	10	1/2	3/4	1.18	30

**WARNING:** This product can expose you to chemicals including Lead, which is known to the State of California to cause cancer and birth defects or other reproductive harm. For more information go to [www.p65warnings.ca.gov](http://www.p65warnings.ca.gov).

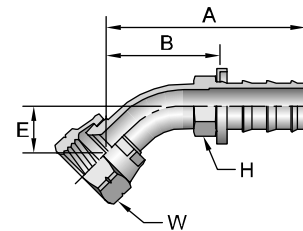

[view on web page](#)

### 37982 Female SAE 45° - Swivel - 90° Elbow

# Part Number	Thread		Hose I.D. inch	A		E		H	W	B	
	inch	7/16x20		inch	mm	inch	mm	inch	inch	inch	mm
37982-4-4	1/4	7/16x20	1/4	1.60	41	0.83	21	7/16	9/16	0.85	22
37982-6-6	3/8	5/8x18	3/8	1.98	50	0.85	22	1/2	3/4	1.08	27

**WARNING:** This product can expose you to chemicals including Lead, which is known to the State of California to cause cancer and birth defects or other reproductive harm. For more information go to [www.p65warnings.ca.gov](http://www.p65warnings.ca.gov).

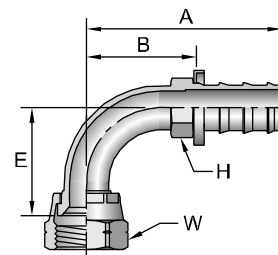

[view on web page](#)

Notch in nut signifies 45° flare.

### 32882 Male Inverted SAE 45° - Swivel

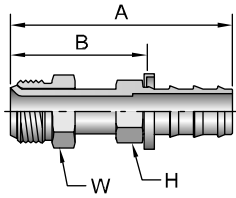

view on web page

# Part Number	Thread		Hose I.D. inch	A		H inch	W inch	B	
	inch	inch		inch	mm			inch	mm
32882-3-4	3/16	3/8x24	1/4	2.15	55	3/8	3/8	1.40	36
32882-4-4	1/4	7/16x24	1/4	2.15	55	7/16	7/16	1.40	36
32882-5-4	5/16	1/2x20	1/4	2.31	59	7/16	1/2	1.56	40
32882-6-6	3/8	5/8x18	3/8	2.58	66	1/2	5/8	1.68	43
32882-8-8	1/2	3/4x18	1/2	2.82	72	5/8	3/4	1.77	45

**WARNING:** This product can expose you to chemicals including Lead, which is known to the State of California to cause cancer and birth defects or other reproductive harm. For more information go to [www.p65warnings.ca.gov](http://www.p65warnings.ca.gov).

### 36782 Male Inverted SAE 45° - Swivel - 45° Elbow

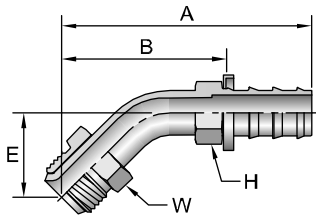

view on web page

# Part Number	Thread		Hose I.D. inch	A		E		H inch	W inch	B	
	inch	inch		inch	mm	inch	mm			inch	mm
36782-6-6	3/8	5/8x18	3/8	2.64	67	0.94	24	1/2	5/8	1.74	44

**WARNING:** This product can expose you to chemicals including Lead, which is known to the State of California to cause cancer and birth defects or other reproductive harm. For more information go to [www.p65warnings.ca.gov](http://www.p65warnings.ca.gov).

### 36982 Male Inverted SAE 45° - Swivel - 90° Elbow

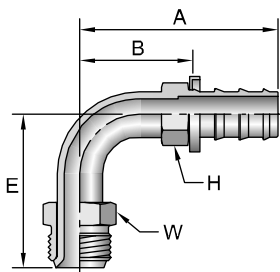

view on web page

# Part Number	Thread		Hose I.D. inch	A		E		H inch	W inch	B	
	inch	inch		inch	mm	inch	mm			inch	mm
36982-6-6	3/8	5/8x18	3/8	2.30	58	1.69	43	1/2	5/8	1.40	36

**WARNING:** This product can expose you to chemicals including Lead, which is known to the State of California to cause cancer and birth defects or other reproductive harm. For more information go to [www.p65warnings.ca.gov](http://www.p65warnings.ca.gov).

### 32982

#### Female Inverted SAE 45° - Rigid

# Part Number	Thread		Hose I.D. inch	A		H inch	B	
	inch			inch	mm		inch	mm
32982-4-4B	1/4	7/16x24	1/4	1.19	30	1/2	0.44	11
32982-5-4B	5/16	1/2x20	1/4	1.25	32	9/16	0.50	13
32982-6-6B	3/8	5/8x18	3/8	1.44	37	3/4	0.54	14
32982-8-8B	1/2	3/4x18	1/2	1.62	41	7/8	0.57	14

**WARNING:** This product can expose you to chemicals including Lead, which is known to the State of California to cause cancer and birth defects or other reproductive harm. For more information go to [www.p65warnings.ca.gov](http://www.p65warnings.ca.gov).

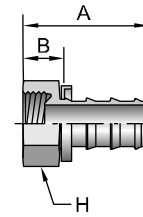

view on web page

### 3JC82

#### Female Seal-Lok® - Swivel - Short

ISO 12151-1 - SWSA

# Part Number	Thread		Hose I.D. inch	A		C		H inch	W inch	B		Additional Material	
	inch			inch	mm	inch	mm			inch	mm	Brass (B)	Stainless Steel (C)
3JC82-4-4	1/4	9/16x18	1/4	1.40	36	0.32	8	9/16	11/16	0.65	17		•
3JC82-6-6	3/8	11/16x16	3/8	1.59	40	0.38	10	11/16	13/16	0.69	18		•
3JC82-8-6	1/2	13/16x16	3/8	1.65	42	0.38	10	13/16	15/16	0.76	19		•
3JC82-8-8	1/2	13/16x16	1/2	1.80	46	0.43	11	13/16	15/16	0.75	19		•
3JC82-10-10	5/8	1x14	5/8	2.40	61	0.53	13	15/16	1-1/8	0.95	24		•
3JC82-12-12	3/4	1-3/16x12	3/4	2.63	67	0.57	14	1-1/8	1-3/8	1.18	30		•

When measuring overall length to the end of the nut, B+C dimensions must be used to calculate cut-off allowance.

**WARNING:** This product can expose you to chemicals including Lead, which is known to the State of California to cause cancer and birth defects or other reproductive harm. For more information go to [www.p65warnings.ca.gov](http://www.p65warnings.ca.gov).

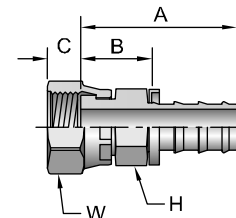

view on web page

See Accessories Section for O-Rings.

### 3J782

#### Female Seal-Lok® - Swivel - 45° Elbow ISO 12151-1 - SWE45

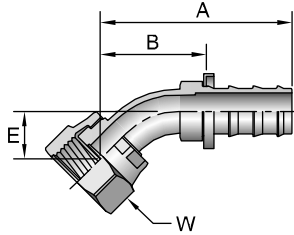

view on web page

# Part Number	Thread		Hose I.D. inch	A		E		W inch	B	
	inch	inch		inch	mm	inch	mm		inch	mm
3J782-4-4	1/4	9/16x18	1/4	1.74	44	0.39	10	11/16	0.99	25
3J782-6-6	3/8	11/16x16	3/8	1.99	51	0.43	11	13/16	1.09	28
3J782-8-8	1/2	13/16x16	1/2	2.41	61	0.59	15	15/16	1.36	35

**WARNING:** This product can expose you to chemicals including Lead, which is known to the State of California to cause cancer and birth defects or other reproductive harm. For more information go to [www.p65warnings.ca.gov](http://www.p65warnings.ca.gov).

### 3J982

#### Female Seal-Lok® - Swivel - 90° Elbow - Short Drop ISO 12151-1 - SWES90

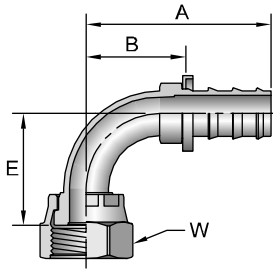

view on web page

# Part Number	Thread		Hose I.D. inch	A		E		W inch	B	
	inch	inch		inch	mm	inch	mm		inch	mm
3J982-4-4	1/4	9/16x18	1/4	1.55	39	0.83	21	11/16	0.80	20
3J982-6-6	3/8	11/16x16	3/8	1.85	47	0.91	23	13/16	0.95	24
3J982-6-8	3/8	11/16x16	1/2	2.09	53	0.91	23	13/16	1.04	26
3J982-8-6	1/2	13/16x16	3/8	1.94	49	1.14	29	15/16	1.04	26
3J982-8-8	1/2	13/16x16	1/2	2.16	55	1.14	29	15/16	1.11	28
3J982-10-10	5/8	1x14	5/8	2.76	70	1.26	32	1-1/8	1.31	33
3J982-12-12	3/4	1-3/6x12	3/4	3.27	83	1.89	48	1-3/8	1.82	46

**WARNING:** This product can expose you to chemicals including Lead, which is known to the State of California to cause cancer and birth defects or other reproductive harm. For more information go to [www.p65warnings.ca.gov](http://www.p65warnings.ca.gov).

See Accessories Section for O-Rings.

### 38282 Push-Lok Union

# Part Number	Hose I.D. inch	A		Additional Material Brass (B)
		inch	mm	
38282-8-8	1/2	2.51	64	•
38282-10-10	5/8	3.31	84	•
38282-12-12	3/4	3.31	84	•

**WARNING:** This product can expose you to chemicals including Lead, which is known to the State of California to cause cancer and birth defects or other reproductive harm. For more information go to [www.p65warnings.ca.gov](http://www.p65warnings.ca.gov).

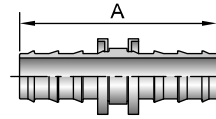

[view on web page](#)

### 3D082 Male Metric L - Rigid - (24° Cone)

# Part Number	Thread mm	Hose I.D. inch	A		H mm	B	
			inch	mm		inch	mm
3D082-6-4	6 M12x1,5	1/4	1.34	34	12	0.55	14
3D082-8-4	8 M14x1,5	1/4	1.38	35	14	0.59	15
3D082-10-6	10 M16x1,5	3/8	1.57	40	17	0.63	16
3D082-12-6	12 M18x1,5	3/8	1.61	41	19	0.67	17

**WARNING:** This product can expose you to chemicals including Lead, which is known to the State of California to cause cancer and birth defects or other reproductive harm. For more information go to [www.p65warnings.ca.gov](http://www.p65warnings.ca.gov).

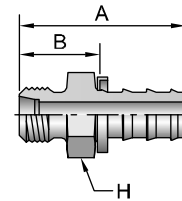

[view on web page](#)

### 31D82 Male Standpipe Metric L - Rigid

# Part Number	R mm	Hose I.D. inch	A		D		B	
			inch	mm	inch	mm	inch	mm
31D82-6-4	6	1/4	1.73	44	0.87	22	0.98	25
31D82-8-4	8	1/4	1.73	44	0.87	22	0.98	25
31D82-10-6	10	3/8	1.93	49	0.91	23	1.02	26
31D82-12-6	12	3/8	1.93	49	0.91	23	1.06	27
31D82-18-10	18	5/8	2.64	67	1.02	26	1.10	28
31D82-22-12	22	3/4	2.72	69	1.10	28	1.22	31

**WARNING:** This product can expose you to chemicals including Lead, which is known to the State of California to cause cancer and birth defects or other reproductive harm. For more information go to [www.p65warnings.ca.gov](http://www.p65warnings.ca.gov).

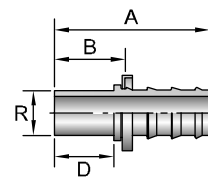

[view on web page](#)

### 39282 Female BSP Parallel Pipe - Swivel - (60° Cone)

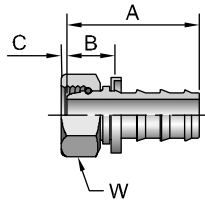

view on web page

# Part Number	Thread inch	Hose I.D. inch	A		C		W mm	B		Additional Material Brass (B)
			inch	mm	inch	mm		inch	mm	
39282-4-4	1/4x19	1/4	1.34	34	0.22	6	17	0.55	14	•
39282-6-6	3/8x19	3/8	1.50	38	0.26	7	19	0.55	14	
39282-8-8	1/2x14	1/2	1.77	45	0.28	7	27	1.06	27	
39282-12-12	3/4x14	3/4	2.13	54	0.35	9	36	1.42	36	

When measuring overall length to the end of the nut, B + C dimensions must be used to calculate cut-off allowances.

**WARNING:** This product can expose you to chemicals including Lead, which is known to the State of California to cause cancer and birth defects or other reproductive harm. For more information go to [www.p65warnings.ca.gov](http://www.p65warnings.ca.gov).

### 3D982 Male BSP Parallel Pipe - Rigid - (60° Cone)

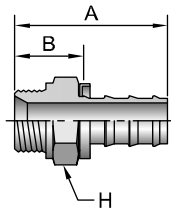

view on web page

# Part Number	Hose I.D. inch	A		H mm	B	
		inch	mm		inch	mm
3D982-2-4	1/4	1.42	36	14	0.63	16
3D982-4-4	1/4	1.61	41	19	0.83	21
3D982-4-6	3/8	1.77	45	19	0.83	21
3D982-6-6	3/8	1.77	45	22	0.87	22
3D982-8-8	1/2	2.09	53	27	0.98	25
3D982-8-10	5/8	2.44	62	27	0.94	24
3D982-12-12	3/4	2.56	65	32	1.06	27

Bonded seal required if fitting is used directly in a port. See Accessories Section.

**WARNING:** This product can expose you to chemicals including Lead, which is known to the State of California to cause cancer and birth defects or other reproductive harm. For more information go to [www.p65warnings.ca.gov](http://www.p65warnings.ca.gov).

### 3B282 Female BSP Parallel Pipe - Swivel - 90° Elbow - (60° Cone)

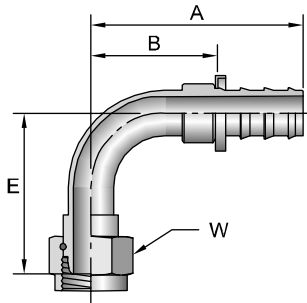



view on web page

# Part Number	Thread inch	Hose I.D. inch	A		E		W mm	B	
			inch	mm	inch	mm		inch	mm
3B282-4-4	1/4x19	1/4	1.65	42	1.02	26	17	1.02	26
3B282-6-6	3/8x19	3/8	2.09	53	1.18	30	19	1.18	30
3B282-8-8	1/2x14	1/2	2.56	65	1.57	40	27	1.57	40
3B282-10-10	5/8x14	5/8	2.99	76	1.57	40	30	1.57	40

**WARNING:** This product can expose you to chemicals including Lead, which is known to the State of California to cause cancer and birth defects or other reproductive harm. For more information go to [www.p65warnings.ca.gov](http://www.p65warnings.ca.gov).



## 34982 DIN Metric Banjo

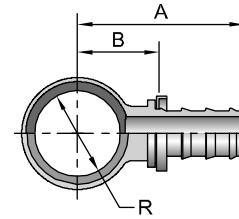

# Part Number			A		B	
	R mm	Hose I.D. inch	inch	mm	inch	mm
34982-8-4	8	1/4	1.42	36	0.63	16
34982-10-4	10	1/4	1.50	38	0.71	18
34982-12-4	12	1/4	1.57	40	0.79	20
34982-12-6	12	3/8	1.73	44	0.79	20
34982-14-4	14	1/4	1.65	42	0.87	22
34982-14-6	14	3/8	1.85	47	0.91	23
34982-16-6	16	3/8	1.93	49	0.98	25
34982-18-8	18	1/2	2.17	55	1.06	27



view on web page

**⚠ WARNING:** This product can expose you to chemicals including Lead, which is known to the State of California to cause cancer and birth defects or other reproductive harm. For more information go to [www.p65warnings.ca.gov](http://www.p65warnings.ca.gov).

## AM Banjo Bolt with DIN Metric Thread

# Part Number			Copper Washer (2)	
R Thread mm	H mm			
AM-03	8	M8x1	12	853009-8
AM-04	10	M10x1	14	853009-10
AM-06	12	M12x1.5	17	853009-12
AM-08	14	M14x1.5	19	853009-14
AM-10	16	M16x1.5	22	853009-16
AM-13	18	M18x1.5	24	853009-18
AM-16	22	M22x1.5	27	853009-22
AM-20	26	M26x1.5	32	853009-26
AM-30	30	M30x1.5	36	853009-30

Two (2) copper washers per bolt must be ordered separately.

**⚠ WARNING:** This product can expose you to chemicals including Lead, which is known to the State of California to cause cancer and birth defects or other reproductive harm. For more information go to [www.p65warnings.ca.gov](http://www.p65warnings.ca.gov).

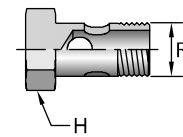

### 3CA82

#### Female Metric L - Swivel - (24° Cone with O-Ring)

ISO 12151-2 - SWS

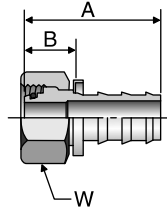

view on web page

# Part Number	Thread mm	Hose I.D. inch	A		W mm	B	
			inch	mm		inch	mm
3CA82-8-4	8	M14x1,5	1/4	1.42	36	17	0.67 17
3CA82-10-6	10	M16x1,5	3/8	1.57	40	19	0.67 17
3CA82-12-6	12	M18x1,5	3/8	1.57	40	22	0.67 17
3CA82-15-8	15	M22x1,5	1/2	1.73	44	27	0.71 18
3CA82-22-12	22	M30x2	3/4	2.28	58	36	0.83 21

**WARNING:** This product can expose you to chemicals including Lead, which is known to the State of California to cause cancer and birth defects or other reproductive harm. For more information go to [www.p65warnings.ca.gov](http://www.p65warnings.ca.gov).

### 3CF82

#### Female Metric L - Swivel - 90° Elbow - (24° Cone with O-Ring)

ISO 12151-2 - SWE

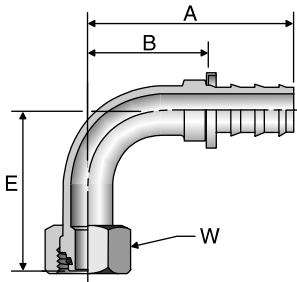

view on web page

# Part Number	Thread mm	Hose I.D. inch	A		E		W mm	B	
			inch	mm	inch	mm		inch	mm
3CF82-12-6	12	M18x1,5	3/8	1.93	49	1.42	36	22	1.06 27

**WARNING:** This product can expose you to chemicals including Lead, which is known to the State of California to cause cancer and birth defects or other reproductive harm. For more information go to [www.p65warnings.ca.gov](http://www.p65warnings.ca.gov).

### 3C482

#### Female Metric L - Swivel - 45° Elbow - (Ball Nose)

End Connection per ISO 8434-1-SWOE

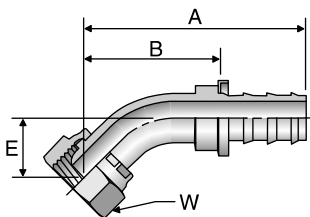

view on web page

# Part Number	Thread mm	Hose I.D. inch	A		E		W mm	B	
			inch	mm	inch	mm		inch	mm
3C482-10-6B	10	M16x1,5	3/8	2.28	58	0.71	18	19	1.38 35

**WARNING:** This product can expose you to chemicals including Lead, which is known to the State of California to cause cancer and birth defects or other reproductive harm. For more information go to [www.p65warnings.ca.gov](http://www.p65warnings.ca.gov).

### 3C582

#### Female Metric L - Swivel - 90° Elbow - (Ball Nose)

End Connection per ISO 8434-1-SWOE

# Part Number	Thread		Hose I.D. inch	A		E		W mm	B	
	mm			inch	mm	inch	mm		inch	mm
3C582-10-6B	10	M16x1,5	3/8	1.93	49	1.30	33	19	1.06	27
3C582-15-8B	15	M22x1,5	1/2	2.36	60	1.54	39	27	1.34	34

**WARNING:** This product can expose you to chemicals including Lead, which is known to the State of California to cause cancer and birth defects or other reproductive harm. For more information go to [www.p65warnings.ca.gov](http://www.p65warnings.ca.gov).

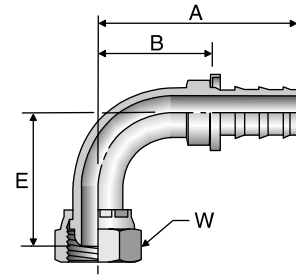

view on web page

### 3C382

#### Female Metric L - Swivel - (Ball Nose)

End Connection per ISO 8434-1-SWOS

# Part Number	Thread		Hose I.D. inch	A		W mm	B	
	mm			inch	mm		inch	mm
3C382-10-6B	10	M16x1,5	3/8	1.50	38	19	0.59	15

**WARNING:** This product can expose you to chemicals including Lead, which is known to the State of California to cause cancer and birth defects or other reproductive harm. For more information go to [www.p65warnings.ca.gov](http://www.p65warnings.ca.gov).

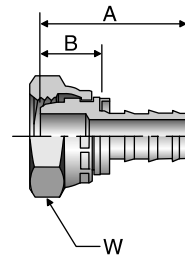

view on web page

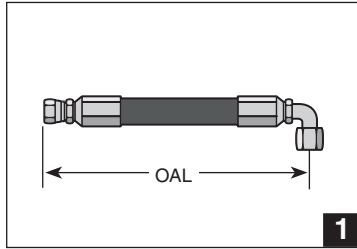

OAL : Straight to 90° Elbow

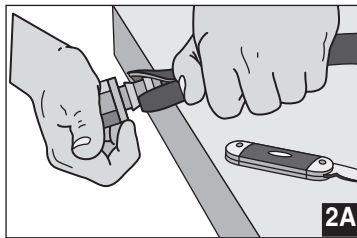
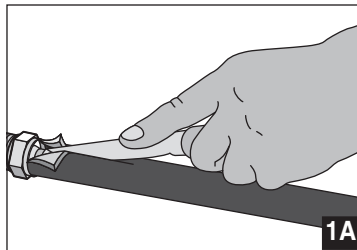
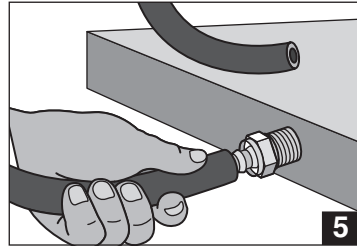

## 82 Series

### Assembly Instructions











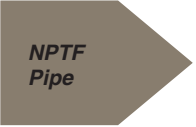
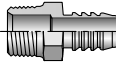
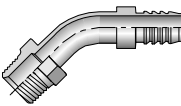
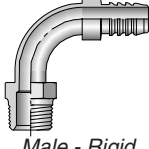



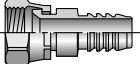
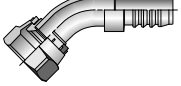
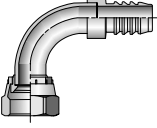

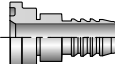
1. Identify over all length (OAL) of hose assembly and the cut off allowance (COA) length of fitting(s) on hose ends by use of the fitting data table.
2. Properly measure and mark hose. Cut hose squarely with a Parker Push-Lok cut-off tool or a sharp knife.
3. Lubricate the Push-Lok fitting, hose I.D., or both with light oil or soapy water only - DO NOT USE HEAVY OIL OR GREASE.
4. Insert fitting into hose until first barb is in the hose.
5. Place end fitting against a flat object such as a work bench or wall. Grip hose approximately one inch from end and push with a steady force until the end of the hose is covered by the yellow plastic cap.

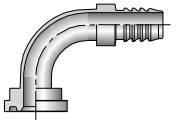
### Disassembly Instructions

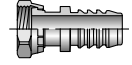
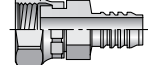
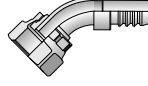
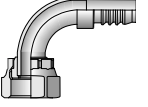
- 1A. Leave fitting in place, and cut hose approximately one inch lengthwise from the yellow plastic cap. **IMPORTANT:** Be careful not to nick barbs when cutting hose.
- 2A. Grip hose firmly and give it a sharp downward tug away from the fitting for disassembly.

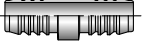
**Caution:** Insert the Push-Lok fitting all the way into the Push-Lok hose until the cut end is concealed by the yellow plastic cap.

**Caution:** Sealing integrity may be damaged by use of exterior clamps.

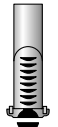
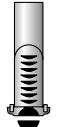
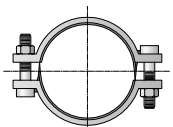
 <p><b>NPTF Pipe</b></p>	<p>0188 B-194</p>  <p>Male - Rigid</p>	<p>3188 B-194</p>  <p>Male - Rigid 45° Elbow</p>	<p>2188 B-194</p>  <p>Male - Rigid 90° Elbow</p>	 <p><b>Straight Thread</b></p>	<p>0588 B-195</p>  <p>Male - Rigid</p>
 <p><b>JIC 37°</b></p>	<p>0688 B-195</p>  <p>Female - Swivel</p>	<p>3788 B-195</p>  <p>Female - Swivel</p>	<p>3988 B-196</p>  <p>Female - Swivel</p>	 <p><b>Flange</b></p>	<p>1588 B-196</p>  <p>Flange Heads</p>
<p>1788 B-197</p>  <p>45° Elbow</p>	<p>1988 B-197</p>  <p>90° Elbow</p>	 <p><b>Seal-Lok® O-Ring Face Seal</b></p>	<p>JS88 B-197</p>  <p>Female - Swivel Long</p>	<p>JC88 B-198</p>  <p>Female - Swivel Short</p>	<p>J788 B-198</p>  <p>Female - Swivel 45° Elbow</p>
<p>J988 B-198</p>  <p>Female - Swivel 90° Elbow</p>	 <p><b>Union</b></p>	<p>8888 B-199</p>  <p>Union</p>	 <p><b>81 Series Crimp Shell</b></p>	<p>81 Series consists of a 10081 crimp shell and is completed by adding any 88 Series fittings.</p>	<p>10081 B-199</p>  <p>81 Series Crimp Shell</p>
 <p><b>Hose Clamp</b></p>	<p>88HC B-199</p>  <p>Hose Clamp</p>	<p>88HC-H B-199</p>  <p>Hose-Clamp</p>	<p>88DB B-199</p>  <p>Heavy Duty Clamp</p>		

**Product Definition**

An 81 series fitting includes any 88 series body plus an 81 series crimp shell (0081). An 88 series fitting includes an 88 series body plus a hose clamp (88HC, 88HC-H or 88DB). To configure either an 81 or 88 series fitting, you will need to order the components separately.

### 0188 Male NPTF Pipe - Rigid

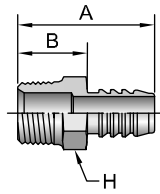

view on web page

# Part Number	Thread inch	Hose I.D. inch	A		H inch	B	
			inch	mm		inch	mm
0188-12-12	3/4x14	3/4	2.25	57	1-1/8	1.13	29
0188-16-16	1x11-1/2	1	2.75	70	1-3/8	1.37	35
0188-20-20	1-1/4x11-1/2	1-1/4	3.05	77	1-3/4	1.47	37
0188-20-24	1-1/4x11-1/2	1-1/2	3.21	82	1-3/4	1.47	37
0188-24-24	1-1/2x11-1/2	1-1/2	3.24	82	2	1.50	38
0188-32-32	2x11-1/2	2	3.49	89	2-1/2	1.66	42

**WARNING:** This product can expose you to chemicals including Lead, which is known to the State of California to cause cancer and birth defects or other reproductive harm. For more information go to [www.p65warnings.ca.gov](http://www.p65warnings.ca.gov).

### 3188 Male NPTF Pipe - Rigid - 45° Elbow

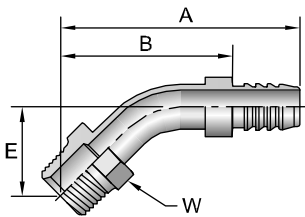

view on web page

# Part Number	Thread inch	Hose I.D. inch	A		E		W inch	B	
			inch	mm	inch	mm		inch	mm
3188-16-16	1x11-1/2	1	4.12	105	1.63	41	1-3/8	2.74	70
3188-20-20	1-1/4x11-1/2	1-1/4	4.54	115	1.77	45	1-3/4	2.96	75

**WARNING:** This product can expose you to chemicals including Lead, which is known to the State of California to cause cancer and birth defects or other reproductive harm. For more information go to [www.p65warnings.ca.gov](http://www.p65warnings.ca.gov).

### 2188 Male NPTF Pipe - Rigid - 90° Elbow

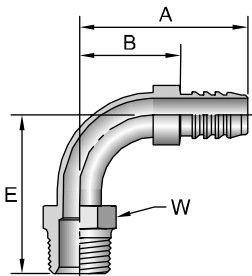

view on web page

# Part Number	Thread inch	Hose I.D. inch	A		E		W inch	B	
			inch	mm	inch	mm		inch	mm
2188-16-16	1x11-1/2	1	3.35	85	3.18	81	1-3/8	1.97	50
2188-20-20	1-1/4x11-1/2	1-1/4	3.80	97	3.41	87	1-3/4	2.21	56
2188-24-24	1-1/2x11-1/2	1-1/2	4.20	107	3.61	92	2	2.46	62
2188-32-32	2x11-1/2	2	4.86	123	4.23	107	2-1/2	3.03	77

**WARNING:** This product can expose you to chemicals including Lead, which is known to the State of California to cause cancer and birth defects or other reproductive harm. For more information go to [www.p65warnings.ca.gov](http://www.p65warnings.ca.gov).

See page B-199 for 81 Series crimp shells and clamps for 88 Series fittings.  
See Equipment Section for assembly and crimping instructions.  
See Accessories Section for O-Rings and Flange Kits.

# 0588

## Male SAE Straight Thread with O-Ring - Rigid

# Part Number	Thread		Hose I.D.		A		H		B	
	inch	inch	inch	inch	inch	mm	inch	inch	inch	mm
0588-12-12	1-1/16x12	3/4	2.13	54	1-1/4	1	25			
0588-16-16	1-5/16x12	1	2.38	60	1-1/2	1	25			
0588-20-20	1-5/8x12	1-1/4	2.59	66	1-7/8	1	25			

**WARNING:** This product can expose you to chemicals including Lead, which is known to the State of California to cause cancer and birth defects or other reproductive harm. For more information go to [www.p65warnings.ca.gov](http://www.p65warnings.ca.gov).

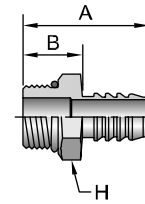

[view on web page](#)

# 0688

## Female JIC 37° - Swivel

# Part Number	Thread		Hose I.D.		A		W		B	
	inch	inch	inch	inch	inch	mm	inch	inch	inch	mm
0688-12-12	3/4	1-1/16x12	3/4	2.66	68	1-1/4	1.53	39		
0688-16-12	1	1-5/16x12	3/4	1.86	47	1-1/2	1.38	35		
0688-16-16	1	1-5/16x12	1	2.72	69	1-1/2	1.34	34		
0688-20-20	1-1/4	1-5/8x12	1-1/4	3.34	85	2	1.75	44		
0688-24-24	1-1/2	1-7/8x12	1-1/2	3.67	93	2-1/4	1.93	49		
0688-32-32	2	2-1/2x12	2	4.14	105	2-7/8	2.31	59		

**WARNING:** This product can expose you to chemicals including Lead, which is known to the State of California to cause cancer and birth defects or other reproductive harm. For more information go to [www.p65warnings.ca.gov](http://www.p65warnings.ca.gov).

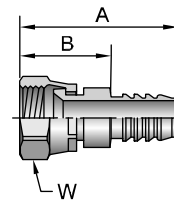

[view on web page](#)

# 3788

## Female JIC 37° - Swivel

# Part Number	Thread		Hose I.D.		A		E		W		B	
	inch	inch	inch	inch	inch	mm	inch	mm	inch	inch	inch	mm
3788-16-16	1	1-5/16x12	1	3.51	89	0.90	23	1-1/2	2.13	54		
3788-20-20	1-1/4	1-5/8x12	1-1/4	3.97	101	1.19	30	2	2.38	60		

**WARNING:** This product can expose you to chemicals including Lead, which is known to the State of California to cause cancer and birth defects or other reproductive harm. For more information go to [www.p65warnings.ca.gov](http://www.p65warnings.ca.gov).

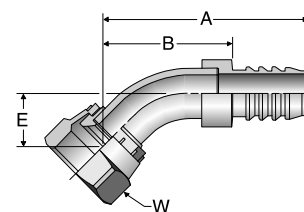

[view on web page](#)

See page B-199 for 81 Series crimp shells and clamps for 88 Series fittings.  
 See Equipment Section for assembly and crimping instructions.  
 See Accessories Section for O-Rings and Flange Kits.

### 3988

#### Female JIC 37° - Swivel

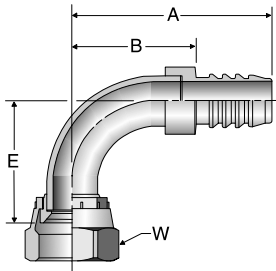

view on web page

# Part Number	Thread		Hose I.D. inch	A		E		W inch	B	
	inch	inch		inch	mm	inch	mm		inch	mm
3988-16-16	1	1-5/16x12	1	3.48	88	2.14	54	1-1/2	2.10	53
3988-20-20	1-1/4	1-5/8x12	1-1/4	3.81	97	2.59	66	2	2.22	56
3988-24-24	1-1/2	1-7/8x12	1-1/2	4.21	107	2.81	71	2-1/4	2.47	63

**WARNING:** This product can expose you to chemicals including Lead, which is known to the State of California to cause cancer and birth defects or other reproductive harm. For more information go to [www.p65warnings.ca.gov](http://www.p65warnings.ca.gov).

### 1588

#### SAE Code 61 Flange Head

#### ISO 12151-3 - S - L

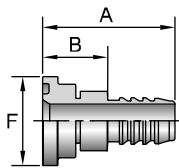

view on web page

# Part Number	Flange inch	Hose I.D. inch	A		F inch	B	
			inch	mm		inch	mm
1588-16-16	1	1	2.57	65	1-3/4	1.19	30
1588-20-20	1-1/4	1-1/4	3.37	86	2	1.78	4
1588-24-24	1-1/2	1-1/2	3.78	96	2-3/8	2.04	52
1588-32-32	2	2	4.32	110	2-13/16	2.49	63
1588-48-40	3	2-1/2	4.62	117	4	2.79	71

See page B-199 for 81 Series crimp shells and clamps for 88 Series fittings.  
See Equipment Section for assembly and crimping instructions.  
See Accessories Section for O-Rings and Flange Kits.

**WARNING:** This product can expose you to chemicals including Lead, which is known to the State of California to cause cancer and birth defects or other reproductive harm. For more information go to [www.p65warnings.ca.gov](http://www.p65warnings.ca.gov).



# 1788

## SAE Code 61 Flange Head - 45° Elbow

ISO 12151-3 - E45S - L (1 Piece: ISO 12151-3 - E45M - L)

# Part Number	Flange inch	Hose I.D. inch	A		E		F inch	B	
			inch	mm	inch	mm		inch	mm
1788-16-16	1	1	3.55	90	1.06	27	1-3/4	2.17	55
1788-20-20	1-1/4	1-1/4	3.90	99	1.13	29	2	2.31	59
1788-24-24	1-1/2	1-1/2	4.15	105	1.11	28	2-3/8	2.41	61
1788-32-32	2	2	4.58	116	1.25	32	2-13/16	2.75	70

**WARNING:** This product can expose you to chemicals including Lead, which is known to the State of California to cause cancer and birth defects or other reproductive harm. For more information go to [www.p65warnings.ca.gov](http://www.p65warnings.ca.gov).

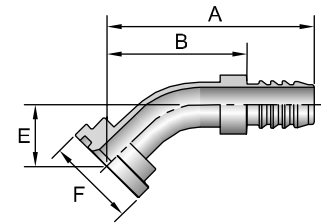

[view on web page](#)

# 1988

## SAE Code 61 Flange Head - 90° Elbow

ISO 12151-3 - E90S - L (1 Piece: ISO 12151-3 - E90M - L)

# Part Number	Flange inch	Hose I.D. inch	A		E		F inch	B	
			inch	mm	inch	mm		inch	mm
1988-16-16	1	1	3.35	85	2.37	60	1-3/4	1.97	50
1988-20-20	1-1/4	1-1/4	3.80	97	2.50	64	2	2.21	56
1988-24-24	1-1/2	1-1/2	4.20	107	2.74	70	2-3/8	2.46	62
1988-32-32	2	2	4.86	123	3.19	81	2-13/16	3.03	77
1988-40-40	2-1/2	2-1/2	5.52	140	3.75	95	3-5/16	3.69	94

**WARNING:** This product can expose you to chemicals including Lead, which is known to the State of California to cause cancer and birth defects or other reproductive harm. For more information go to [www.p65warnings.ca.gov](http://www.p65warnings.ca.gov).

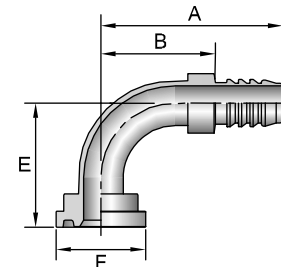

[view on web page](#)

# JS88

## Female Seal-Lok® - Swivel - Long

ISO - 12151-1 - SWSB

# Part Number	Thread		Hose I.D. inch	A		W inch	B		C	
	inch	inch		inch	mm		inch	mm	inch	mm
JS88-20-20	1-1/4	1-11/16x12	1-1/4	3.21	82	1-7/8	1.62	41,1	0.59	15,0
JS88-24-24	1-1/2	2x12	1-1/2	3.47	88	2-1/4	1.73	43,9	0.62	15,7

**WARNING:** This product can expose you to chemicals including Lead, which is known to the State of California to cause cancer and birth defects or other reproductive harm. For more information go to [www.p65warnings.ca.gov](http://www.p65warnings.ca.gov).

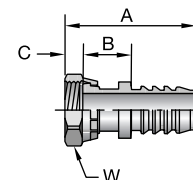

[view on web page](#)

See page B-199 for 81 Series crimp shells and clamps for 88 Series fittings.  
See Equipment Section for assembly and crimping instructions.  
See Accessories Section for O-Rings and Flange Kits.

### JC88

#### Female Seal-Lok - Swivel - Short

ISO 12151- 1 - SWSA

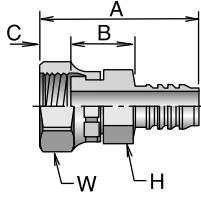

view on web page

# Part Number	Thread		Hose I.D. inch	A		C	H		W		B
	inch	inch		inch	mm		inch	inch	inch	mm	
JC88-12-12	3/4	1-3/16x12	3/4	2.80	71	0.57	1-1/8	1-3/8	1.70	43	
JC88-16-12	1	1-7/16x12	3/4	2.82	72	0.58	1-3/8	1-5/8	1.69	43	
JC88-16-16	1	1-7/16x12	1	3.07	78	0.59	1-3/8	1-5/8	1.69	43	
JC88-20-16	1-1/4	1-11/16x12	1	3.08	78	0.59	1-7/8	1-5/8	1.70	43	
JC88-20-20	1-1/4	1-11/16x12	1-1/4	3.29	84	0.59	1-7/8	1-7/8	1.70	43	

When measuring overall length to the end of the nut, B+C dimensions must be used to calculate cut-off allowance.

**WARNING:** This product can expose you to chemicals including Lead, which is known to the State of California to cause cancer and birth defects or other reproductive harm. For more information go to [www.p65warnings.ca.gov](http://www.p65warnings.ca.gov).

### J788

#### Female Seal-Lok - Swivel - 45° Elbow

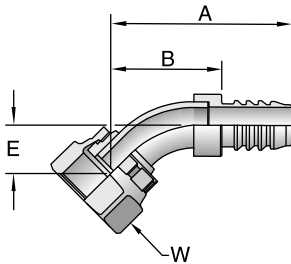

view on web page

# Part Number	Thread		Hose I.D. inch	A		E		W	B	
	inch	inch		inch	mm	inch	mm		inch	mm
J788-16-16	1	1-7/16x12	1	3.79	96	0.94	24	1-5/8	2.41	61
J788-20-20	1-1/4	1-11/16x12	1-1/4	3.71	94	0.94	24	1-7/8	2.12	54

**WARNING:** This product can expose you to chemicals including Lead, which is known to the State of California to cause cancer and birth defects or other reproductive harm. For more information go to [www.p65warnings.ca.gov](http://www.p65warnings.ca.gov).

### J988

#### Female Seal-Lok - Swivel - 90° Elbow - Short Drop

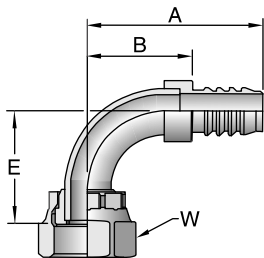

view on web page

# Part Number	Thread		Hose I.D. inch	A		E		W	B	
	inch	inch		inch	mm	inch	mm		inch	mm
J988-12-12	3/4	1-3/16x12	3/4	2.85	72	1.83	46	1-3/8	1.72	44
J988-16-16	1	1-7/16x12	1	3.74	95	2.19	56	1-5/8	2.36	60
J988-16-16C	1	1-7/16x12	1	3.75	95	2.22	56	1-5/8	2.37	60
J988-20-20	1-1/4	1-11/16x12	1-1/4	4.26	108	2.51	64	1-7/8	2.67	68
J988-24-24	1-1/2	2x12	1-1/2	5.27	134	2.68	68	2-1/4	3.53	90

**WARNING:** This product can expose you to chemicals including Lead, which is known to the State of California to cause cancer and birth defects or other reproductive harm. For more information go to [www.p65warnings.ca.gov](http://www.p65warnings.ca.gov).

## 8888 Union (Hose Splicer)

# Part Number	Hose I.D. inch	A	
		inch	mm
8888-16-16	1	3.21	82
8888-20-20	1-1/4	3.61	92

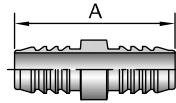

view on web page

**WARNING:** This product can expose you to chemicals including Lead, which is known to the State of California to cause cancer and birth defects or other reproductive harm. For more information go to [www.p65warnings.ca.gov](http://www.p65warnings.ca.gov).

## 88HC Hose Clamp (Worm Gear)

# Part Number	Hose I.D. inch
88HC-12	3/4
88HC-16	1
88HC-20	1-1/4
88HC-24	1-1/2
88HC-32	2



view on web page

See page D-38 for more information.

**WARNING:** This product can expose you to chemicals including Lead, which is known to the State of California to cause cancer and birth defects or other reproductive harm. For more information go to [www.p65warnings.ca.gov](http://www.p65warnings.ca.gov).

## 10081 Crimp Shell

# Part Number	Hose I.D. inch
10081-12	3/4
10081-16	1
10081-20	1-1/4
10081-24	1-1/2
10081-32	2



view on web page

81 Series consists of a 10081 crimp shell and is completed by adding any 88 Series Fittings. See Equipment Section for complete 81 Series Assembly and Crimping instructions.

## 88HC-H Hose Clamp (High Torque Worm Gear)

# Part Number	Hose I.D. inch
88HC-16H	1
88HC-20H	1-1/4
88HC-32H	2
88HC-40H	2-1/2
88HC-48H	3



view on web page

See page D-38 for more information.

## 88DB Heavy Hose Clamp (Double Bolt)

# Part Number	Hose I.D. inch
88DB-12	3/4
88DB-16	1
88DB-20	1-1/4
88DB-24	1-1/2
88DB-32	2

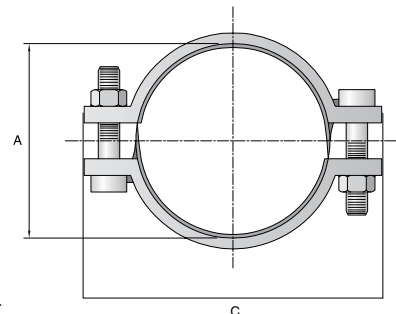

See page D-38 for more information.

**WARNING:** This product can expose you to chemicals including Lead, which is known to the State of California to cause cancer and birth defects or other reproductive harm. For more information go to [www.p65warnings.ca.gov](http://www.p65warnings.ca.gov).

## 88 Series

### Hose Assembly Instructions

1. Identify Over All Length (OAL) of hose assembly and the Cut Off Allowance (COA) length of fitting(s) by use of the fitting data table. Properly measure and mark hose. Cut hose cleanly and squarely to length. Trim any exposed wire reinforcement to prevent injury in service.
  2. Slide clamp(s) onto hose and lubricate hose. Push hose onto fitting until hose bottoms against stop ring or hex.
  3. Position hose clamp(s) as shown and secure with a screwdriver or wrench to tightening torque listed on page D-37. Maintain "A" dimensions as shown below for proper clamp positioning of both HC clamps and HC-H clamps.
- 3A. Evenly attach double bolt clamps for maximum grip.

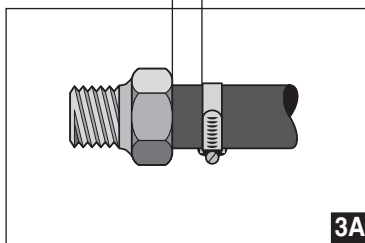
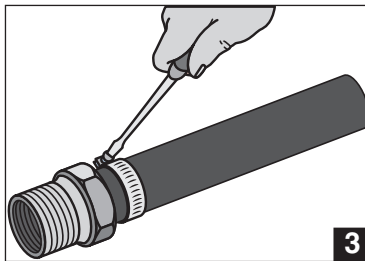
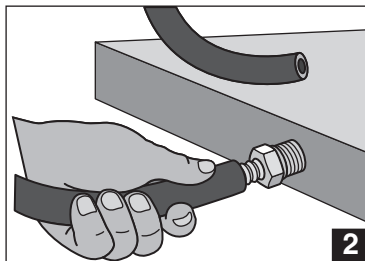
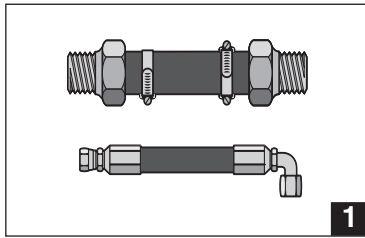

Hose I.D. inch	A	
	inch	mm
-12	1/4	6.35
-16	3/8	9.53
-20	3/8	9.53
-24	1/2	12.70
-32	1/2	12.70

**Note:** For permanent installation of 88 Series Fittings, an 81 Series Crimp Shell must be added. See Equipment Section for assembly and crimping instructions.



# Equipment

Parkrimp Crimpers Die Selection Charts  
Pumps Hose Assembly Equipment

A	<b>Crimpers</b>	KrimpNODE™ C-6 	Karrykrimp C-7 	Karrykrimp Bench Mount C-7 	Karrykrimp 2 C-9 	Karrykrimp 2 Bench Mount C-9 
	Parkrimp 1 C-11 	Parkrimp 2 C-12 	TH8-380 C-14 	<b>Conversion Kits</b>	Weatherhead Conversion Kit C-16  8WC-001	<b>Portable Pumps</b>
B	82C-0HP C-16  Hand Pump	85C-0HP C-16  Hand Pump	82C-0EP C-17  Electric Pump	85C-0EP C-17  Electric Pump	82C-0AP C-17  Air/Hydraulic Pump	<b>Hose Cut-Off Machines</b>
	86C-220V and 86C-220V3 C-23 	TH3-EM3-110V C-23 	332T-115V C-24 	239 and 339 C-24 	<b>Hose Cleaning Kits</b>	TH6-10-HL-10-2 C-25  Premium Hose Cleaning Kit
C	TH6-10-EL-8 C-25  Economy Hose Cleaning Kit	<b>Accessories</b>	Parker Clean Seal C-26 	871522 C-27  Handycut - Hose Cut-Off Machine	881540 C-27  Push-Lok Cut-Off & Assembly Tool	TH9-1 C-27  Hose Insertion Depth Blocks
	TH11-1 C-27  Hose Cut-Off Tool	432-115V C-28  Hozemblem	80C-0DR and 83C-0DR C-28  Die Storage Racks	80C-SDR C-28  Swivel Die Rack	TH2-7 C-28  Fittings Push-On Stand	652200 C-29  Mandrel Tool Kit 22 Series
D	2727 and 2726 C-29  Mandrel Tool Kit 23 Series	TH2-7M25-6 and TH2-7M25-8 C-29  Mandrels - 25 Series	652201 C-29  Assembly Tools 22 Series	Hose Oil C-30  Hose Oil	Lubricant C-30  Accrolube High Efficiency	Small Crimper Hood C-30 
	Large Crimper Hood C-30 					
E						

*Notes*

**A**

**B**

**C**

**D**

**E**



# Hose Assemblies Are Easy With the Parkrimp System.

Since its introduction in 1980, the Parkrimp family of crimping machines has led the industry in ease of use and rugged durability.

*With Parkrimp, you benefit from a full length crimp.*

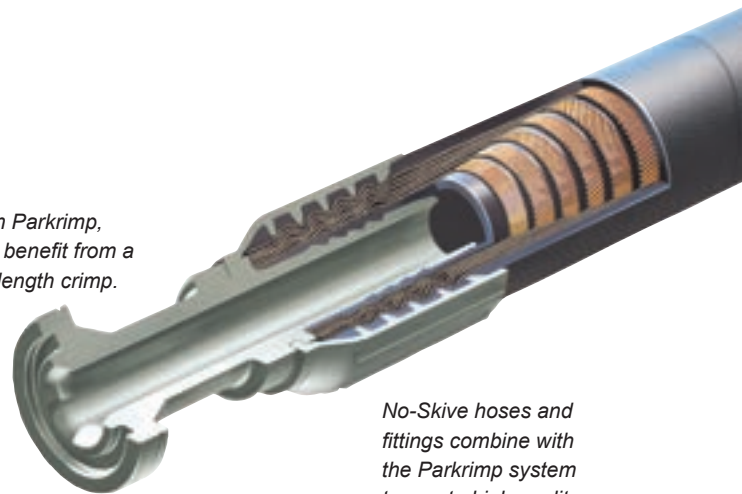

*No-Skive hoses and fittings combine with the Parkrimp system to create high quality, reliable hydraulic hose assemblies every time.*

*Our low profile design makes routing hose assemblies easy.*

When it comes to hose assemblies, no one puts it all together like Parker. From high-volume productivity to portable on-site assembly, we offer a variety of crimping machines, No-Skive hoses, and No-Skive fittings to meet your needs.

With Parkrimp equipment, anyone can make factory-quality hose assemblies quickly, easily, and cost effectively. Parkrimp machines are simple to operate and they're built to provide years of dependable service. Seven Parkrimp models – an entire family of crimpers – are available to meet your bench-mounted or portable needs, crimping straight or bent-stem fittings from 1/4" to 2" in diameter. Just use our No-Skive hoses and fittings to create leak-free hose assemblies whenever and wherever you need them.

The complete system from one source: No-Skive hose, No-Skive fittings, and crimping machines with worldwide availability and service.

*Eight segment crimp dies provide a smooth, even, 360-degree crimp.*

*Our linked crimp dies keep die segments together. No loose parts to mismatch or misplace.*

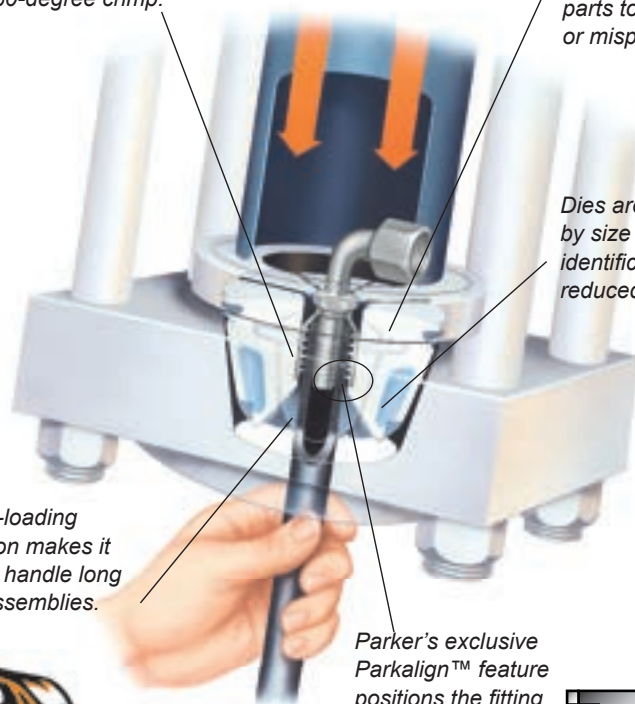

*Dies are color-coded by size for easy identification and reduced set-up time.*

*Bottom-loading operation makes it easy to handle long hose assemblies.*

*Parker's exclusive Parkalign™ feature positions the fitting in the dies perfectly every time.*

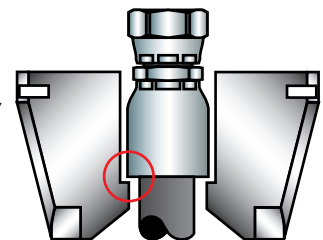

## Selecting the right die.

Once the proper Parker Hose and Fitting is selected that meets your application requirements, you will need to select the proper die to assemble them together.

Based on the hose size and approved fitting, select the proper color coded die, as called out in the chart below.

**Example:**

Hose	387-4
Fitting	43 Series
Die Body Color	Silver
Die Cavity Color (-4)	<b>RED</b>

Based on the Parkrimp machine being used to assemble the hose and fitting, individual die part numbers and tooling selection for your assembly can be found in Section C of this catalog.

For general hose assembly instructions for all Parkrimp machines, please turn to pages C-19 and C-20. (An instructional video is a standard part of each Parkrimp machine shipped from the manufacturer.)

Parker Hose Products Division also offers a full line of crimping accessories, including conversion kits, cabinets, cut-off saws, push-on tables, die racks, and mandrel tool kits.

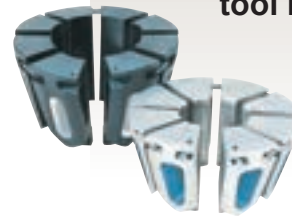

Hose Dash Size	Die Cavity Color Code	43 & 26 Series Die Body Color	77 Series Die Body Color	79 Series Die Body Color	76 Series Die Body Color	25 Series Die Body Color	81 Series Die Body Color
		Silver	Black	Olive Drab	Silver	Silver	Silver
-4	RED		N/A	N/A	N/A	N/A	N/A
-5	PURPLE		N/A	N/A	N/A	N/A	N/A
-6	YELLOW			N/A	N/A		N/A
-8	BLUE			N/A	N/A		N/A
-10	ORANGE			N/A	N/A	N/A	N/A
-12	GREEN			N/A		N/A	
-16	BLACK			N/A		N/A	
-20	WHITE				N/A	N/A	
-24	RED				N/A	N/A	
-32	GREEN				N/A	N/A	

Hose Dash Size	Die Cavity Color Code	HY Series Die Body Color
		Silver
-4	BROWN	
-5	BROWN	
-6	BROWN	
-8	BROWN	
-10	BROWN	
-12	BROWN	
-16	BROWN	

**WARNING:** This product can expose you to chemicals including Lead, which is known to the State of California to cause cancer and birth defects or other reproductive harm. For more information go to [www.p65warnings.ca.gov](http://www.p65warnings.ca.gov).

Reference pages C-6 through C-14 for specific tool information regarding hose, fitting, and crimper combinations. Be sure to check [www.parker.com/crimpsource](http://www.parker.com/crimpsource) for the most up to date information and crimp specifications.

A

B

C

D

E

# KrimpNODE™

## Smarter Crimper. Smarter Choice.

A

Do you know where your crimpers are? Parker's Hose Products Division can help you take the guess work out of determining their location. Are your crimpers being used? Our new KrimpNODE™ sensor can track crimper usage and deliver this data, allowing you to analyze both usage and location.

B

If you have an existing crimper, order our KrimpNODE™ Retrofit Kit or if you need a new crimper, order one of our Parkrimp crimpers that come standard with KrimpNODE™.

KrimpNODE™ sensors can be added to existing crimpers via our KrimpNODE™ Retrofit Kit through any Parker Distributor.

Karrykrimp 2, Parkrimp 1 and Parkrimp 2 come standard with KrimpNODE™ sensor

Activate, track and increase sales with Parker Hose Products KrimpNODE™.

C

**For anyone having existing crimpers that want to order the sensor to attach:**

<u>Crimper</u>	<u>Sensor Retrofit Kit:</u>
Parkrimp 1	PT# PKT26189
Parkrimp 2	PT#PKT26189
Karrykrimp 2	PT#PK26190

D

### Capability:

- Records crimp activity
- Real time connection to the cloud
- GPS position
- Unlimited capacity, all your crimpers can be monitored

### Features:

- Alerts/notifications via email or text
- Customizable dashboards

E



### Specifications:

- Available on Parkrimp1, Parkrimp2, and Karrykrimp2
- Retrofit kits available for installed units

**Note:**

- For crimp instructions, see pages C-19 and C-20.
- Hose assemblies must be inspected for cleanliness and free of all foreign particles.
- Parker Hannifin will not accept responsibility for the operation of, or provide warranty coverage for, a crimper that is operated by a power unit other than equipment supplied by Parker Hannifin for the express purpose of operating the crimper.

# Karrykrimp

The Karrykrimp is now available in a modular design with all the familiar Parkrimp System advantages.

The same unit now offers portability and bench mountability.



[view on web page](#)

## Capability

- Up to 1-1/4" ID 2 wire braided hose
- Up to 5/8" ID 4 wire spiral hose
- Only steel fittings

## Features

- Now comes standard with KrimpNODE  
See page C-6 for more information on KrimpNODE™
- Portable, compact rugged design
- Numerous portable power unit options available
- Pivoting pusher design for easy die change out
- Increased height enables longer bent tube fittings to be crimped
- For use with 25, 26, 43, 81, and HY Series fittings

## Specifications

- Dimensions: 15" wide, 12" deep, 30" high
- Weight: 70 lbs (without power unit)
- Rating: 30 ton force @ 10,000 psi maximum
- Crimp Cycle Time: 30 seconds 82C-0EP power unit (1/2" 43 Series)
- Reference pages C-16 and C-17 for information on available power units

## Standard Equipment

Part Number			Description	Individual Part Number
82C-CHD	82C-061L	82C-KKB		
●	●	●	Crimp Head	82C-CHD
		●	Bench Power Unit Assembly	*85C-ZMS
●	●	●	Silver Die Ring	82C-R01
●	●	●	Black Die Ring	82C-R02
	●		Hose Assembly	85C-00L
	●		Stand Assembly	85C-STD
		●	Hose Assembly	85C-03L

**WARNING:** This product can expose you to chemicals including Lead, which is known to the State of California to cause cancer and birth defects or other reproductive harm. For more information go to [www.p65warnings.ca.gov](http://www.p65warnings.ca.gov).

**Note:**

- For crimp instructions, see pages C-19 and C-20.
- Hose assemblies must be inspected for cleanliness and free of all foreign particles.
- Parker Hannifin will not accept responsibility for the operation of, or provide warranty coverage for, a crimper that is operated by a power unit other than equipment supplied by Parker Hannifin for the express purpose of operating the crimper.

# Karrykrimp Bench Mount



[view on web page](#)

## Capability

- Up to 1-1/4" ID 2 wire braided hose
- Up to 5/8" ID 4 wire spiral hose
- Only steel fittings

## Features

- Faster cycle times on bench mounted units
- Pivoting pusher design for easy die change out
- Compact bench mount design
- Increased height enables longer bent tube fittings to be crimped
- For use with 25, 26, 43, 81, and HY Series fittings

## Specifications

- Dimensions: 19" wide, 23" deep, 27-1/2" high
- Weight: 220 lbs
- Rating: 30 ton force @ 10,000 psi maximum
- Crimp Cycle Time: 8 seconds (1/2" 43 Series straight fittings)
- Full Stroke Crimp Time: 15 seconds
- Hydraulic Fluid: Enerpac Oil
- This unit is designed to make about 200 crimps per day and is not designed to be a production crimper. Exceeding these suggested production amounts will significantly reduce the life expectancy of the crimper components.

**\*Note:** Power unit is factory wired to operate at 115 volt. **A 20 amp dedicated circuit is required to operate at this voltage. Do not use extension cords to operate this machine.**

The electric motor is dual voltage, 50/60 HZ, suitable for 208-230/115 volt. The motor and control circuit can be rewired by a qualified electrician to operate at alternate voltage. See motor name plate and wiring diagrams.

## Optional Tooling

- Die Kit 43K-KDA (Includes 43 Series dies in sizes 1/4", 3/8", 1/2", 3/4", 1" and 1-1/4" only)



Parker Hannifin Corporation  
Hose Products Division  
30240 Lakeland Blvd.  
Wickliffe, Ohio 44092

### Karrykrimp/Karrykrimp Bench Mount Hose Die Selection Chart

Fitting Series	HOSE	-4 RED	-5 PUR	-6 YEL	-8 BLU	-10 ORG	-12 GRN	-16 BLK	-20 WHT	Die Ring
43 Series	Die Part Number	80C-A04	80C-A05	80C-A06	80C-A08	80C-A10	80C-A12	80C-A16	80C-A20	
	<b>GLOBALCORE</b> 187/187ST/TC (-8 THRU -16) 387/387ST/TC (-4 THRU -16), 487/487ST/TC (-4 THRU -12) 787/787ST/TC (-4 & -6), 797/797ST/TC (-4 & -6)	0.645 0.665	0.710 0.730	0.825 0.845	0.945 0.965	1.060 1.080	1.245 1.265	1.590 1.610	1.970 1.990	
	351ST/TC 422 426 431 436 451ST/TC 471ST/TC 472LT 482ST/TC									SILVER
	<b>GLOBALCORE</b> 722/722ST/TC (-6 THRU -10)	0.685 0.705	0.750 0.770	0.865 0.885	0.985 1.005	1.100 1.120	1.285 1.305	1.630 1.650	2.010 2.030	
	421WC 302 722LT (-6 THRU -10) 881									BLACK
25 Series	Die Part Number			80C-Y06	80C-Y08					
	271			0.680 0.700	0.825 0.845					
26 Series	Die Part Number	80C-E04	80C-E05	80C-E06	80C-E08	80C-E10	80C-E12	80C-E16		
	213 285 293	0.460 0.480	0.520 0.540	0.575 0.595	0.670 0.690	0.805 0.825	0.915 0.935	1.175 1.195		
	201 206 221FR 225 226 244 266 SS25UL	0.500 0.520	0.560 0.580	0.615 0.635	0.710 0.730	0.845 0.865	0.955 0.975	1.215 1.235		
81 Series	Die Part Number						80C-V12	80C-V16	80C-V20	
	811 811HT 881						1.155 1.175	1.450 1.470	1.740 1.760	
HY Series	Die Part Number	80C-H595		80C-H735	80C-H860	80C-H1015	80C-H1170			
	611HT	0.575 0.595		0.720 0.740	0.860 0.880	0.995 1.015	1.140 1.160			
	Die Part Number	80C-H595				80C-H1015	80C-H1170	80C-H1365		
	801 836	0.575 0.595				0.995 1.015	1.140 1.160	1.350 1.370		
	Die Part Number			80C-H735	80C-H860					
	801 836			0.755 0.775	0.890 0.910					

Caution: Read the operations and technical manual before attempting to operate this machine. Do not operate this machine without guard in place. Keep hands clear of moving parts when operating machine.

Note: Do not use this machine to assemble stainless steel fittings.

Information on this decal is subject to change without notice. For the most current crimp specifications, please visit Crimpsource at [www.parker.com/crimpsource](http://www.parker.com/crimpsource). New decals can be ordered at Parker website <https://parker.cp.imtco.com/Account/Login>.

Decal Part Number:  
82C-CRIMPDECAL  
REV. F

**WARNING:** This product can expose you to chemicals including Lead, which is known to the State of California to cause cancer and birth defects or other reproductive harm. For more information go to [www.p65warnings.ca.gov](http://www.p65warnings.ca.gov).

# Karrykrimp 2

The Karrykrimp 2 is now available in a modular design with all the familiar Parkrimp System advantages.

The same unit now offers portability and bench mountability.



view on web page

## Capability

- Up to 1-1/4" ID 2 wire braided hose
- Up to 1-1/4" ID 4 wire spiral hose
- Up to 1" ID 6 wire spiral hose

## Features

- Now comes standard with KrimpNODE  
See page C-6 for more information on KrimpNODE™
- Portable, compact rugged design
- Numerous portable power unit options available
- Pivoting pusher design for easy die change out
- For use with 25,26, 43, 70, 71, 77, 81 and HY Series fittings

## Specifications

- Dimensions: 14" wide, 14" deep, 31-1/2" high
- Weight: 120 lbs (without power unit)
- Rating: 60 ton force @ 10,000 psi maximum
- Cycle Time: 15 seconds with 85C-0EP power unit (1/2" 43 series)
- Reference pages C-16 and C-17 for information on available power units

## Standard Equipment

Part Number			Description	Individual Part Number
85C-CHD	85C-061L	85C-KKB		
●	●	●	Crimp Head	85C-CHD
		●	Bench Power Unit Assembly	*85C-ZMS
●	●	●	Silver Die Ring	85C-R01
●	●	●	Black Die Ring	85C-R02
	●		Hose Assembly	85C-00L
	●		Stand Assembly	85C-STD
		●	Hose Assembly	85C-03L

**WARNING:** This product can expose you to chemicals including Lead, which is known to the State of California to cause cancer and birth defects or other reproductive harm. For more information go to [www.p65warnings.ca.gov](http://www.p65warnings.ca.gov).

**Note:**

- For crimp instructions, see pages C-19 and C-20.
- Hose assemblies must be inspected for cleanliness and free of all foreign particles.
- Parker Hannifin will not accept responsibility for the operation of, or provide warranty coverage for, a crimping tool that is operated by a power unit other than equipment supplied by Parker Hannifin for the express purpose of operating the crimping tool.

# Karrykrimp 2 Bench Mount



view on web page

## Capability

- Up to 1-1/4" ID 2 wire braided hose
- Up to 1-1/4" ID 4 wire spiral hose
- Up to 1" ID 6 wire spiral hose

## Features

- Faster cycle times on bench mounted units
- Pivoting pusher design for easy die change out
- Compact bench mount design
- For use with 25, 26, 43, 70, 71, 77, 81 and HY Series fittings

## Specifications

- Dimensions: 19" wide, 24" deep, 28" high
- Weight: 265 lbs
- Rating: 60 ton force @ 10,000 psi maximum
- Crimp Cycle Time: 15 seconds (1/2" 43 series straight fitting)
- Full Stroke Cycle Time: 24 seconds
- Hydraulic Fluid: Enerpac Oil
- This unit is designed to make about 200 crimps per day and is not designed to be a production crimper. Exceeding these suggested production amounts will significantly reduce the life expectancy of the crimper components.

**\*Note:** Power unit is factory wired to operate at 115 volt. **A 20 amp dedicated circuit is required to operate at this voltage. Do not use extension cords to operate this machine.**

The electric motor is dual voltage, 50/60 HZ, suitable for 208-230/115 volt. The motor and control circuit can be rewired by a qualified electrician to operate at alternate voltage. See motor name plate and wiring diagrams.

## Optional Tooling

- Die Kit KK2-KDA (Includes 43 Series dies in sizes 1/4", 3/8", 1/2", 3/4", 1" and 1-1/4" and 77 Series dies in sizes 1/2", 5/8", 3/4" and 1" only).



Parker Hannifin Corporation  
Hose Products Division  
30240 Lakeland Blvd.  
Wickliffe, Ohio 44092

### Karrykrimp 2/Karrykrimp 2 Bench Mount Hose Die Selection Chart

Fitting Series	HOSE	-4 RED	-5 PUR	-6 YEL	-8 BLU	-10 ORG	-12 GRN	-16 BLK	-20 WHT	Die Ring
	Die Part Number	80C-A04	80C-A05	80C-A06	80C-A08	80C-A10	80C-A12	80C-A16	80C-A20	
43 Series	<b>GLOBALCORE</b> 187/187ST/TC 387/387ST/TC (-4 THRU -16), 487/487ST/TC (-4 THRU -12) 787/787ST/TC (-4 & -6), 797/797ST/TC (-4 & -6)	0.645 0.665	0.710 0.730	0.825 0.845	0.945 0.965	1.060 1.080	1.245 1.265	1.590 1.610	1.970 1.990	 SILVER
	351ST/TC 422 426 431 436 451ST/TC 471ST/TC 472TC/LT 482ST/TC									
	<b>GLOBALCORE</b> 387/387ST/TC (-20 ONLY) 487/487ST/TC (-16 ONLY) 722/722ST/TC (-6 THRU -16)	0.685 0.705	0.750 0.770	0.865 0.885	0.985 1.005	1.100 1.120	1.285 1.305	1.630 1.650	2.010 2.030	 BLACK
	302 421WC 722LT (-6 THRU -20) 881 722ST/TC (-20 ONLY)									
NOTES		Crimp Diameter range for 722/722LT/ST/TC Size -16 is 1.630/1.660. Crimp Diameter range for 722/722LT/ST/TC Size -20 is 2.010/2.040.								
71 Series	Die Part Number			83C-D06	83C-D08	83C-D10	83C-D12	83C-D16	83C-D20	
	721/721ST/TC			0.950 0.970	1.100 1.120	1.220 1.240	1.355 1.375	1.695 1.715	2.025 2.045	 SILVER
NOTES		71 Series Size -20 Stainless Steel Fittings can not be Crimped on this Machine.								
77 Series	Die Part Number			80C-CS08	80C-CS10	80C-CS12	80C-CS16			
	<b>GLOBALCORE</b> 787/787ST/TC 797/797ST/TC (-8 THRU -12)			0.930 0.950	1.057 1.077	1.245 1.265	1.541 1.571			 BLACK
NOTES		77 Series Size -16 Stainless Steel Fittings can not be Crimped on this Machine.								
25 Series	Die Part Number			80C-Y06	80C-Y08					 SILVER
	271			0.680 0.700	0.825 0.845					
26 Series	Die Part Number	80C-E04	80C-E05	80C-E06	80C-E08	80C-E10	80C-E12	80C-E16		
	213 285 293	0.460 0.480	0.520 0.540	0.575 0.595	0.670 0.690	0.805 0.825	0.915 0.935	1.175 1.195		 SILVER
	201 221FR 226 266	0.500	0.560	0.615	0.710	0.845	0.955	1.215		 BLACK
	206 225 244 SS25UL	0.520	0.580	0.635	0.730	0.865	0.975	1.235		
81 Series	Die Part Number					80C-V12	80C-V16	80C-V20		
	811 811HT 881					1.155 1.175	1.450 1.470	1.740 1.760		 SILVER
HY Series	Die Part Number	80C-H595		80C-H735	80C-H860	80C-H1015	80C-H1170			
	611HT	0.575 0.595		0.720 0.740	0.860 0.880	0.995 1.015	1.140 1.160			 SILVER
	Die Part Number	80C-H595				80C-H1015	80C-H1170	80C-H1365		
	801 836	0.575 0.595				0.995 1.015	1.140 1.160	1.350 1.370		 SILVER
	Die Part Number			80C-H735	80C-H860					
	801 836			0.755 0.775	0.890 0.910					 BLACK
Caution: Read the operations and technical manual before attempting to operate this machine. Do not operate this machine without guard in place. Keep hands clear of moving parts when operating machine.						Note: Stainless steel crimp diameters can be up to .010" greater than table listings.				
Information on this decal is subject to change without notice. For the most current crimp specifications, please visit Crimpsource at <a href="http://www.parker.com/crimpsource">www.parker.com/crimpsource</a> . New decals can be ordered at Parker website <a href="https://parker.cp.imtco.com/Account/Login">https://parker.cp.imtco.com/Account/Login</a> .						Decal Part Number: 85C-CRIMPDECAL REV. G				

**WARNING:** This product can expose you to chemicals including Lead, which is known to the State of California to cause cancer and birth defects or other reproductive harm. For more information go to [www.p65warnings.ca.gov](http://www.p65warnings.ca.gov).

# Parkrimp 1



## Features

- Now comes standard with KrimpNODE  
See page C-6 for more information on KrimpNODE™
- Compact bench mount design
- Engineered for optimal reliability, consistency, and durability
- All in one crimper and power unit design
- For use with 25, 26, 43, 81, and HY Series fittings

## Specifications

- Dimensions: 26" wide, 20" deep, 25" high
- Weight: 275 lbs (with power unit)
- Rating: 30 ton force @ 3,000 psi maximum
- Full Cycle Time: 20 seconds
- Hydraulic Fluid: AW32 oil
- **Note:** Includes a 115/230 volt, 1 phase, 60 hertz power unit wired for 115V. This unit comes with a 20 AMP male plug and must be run on a dedicated 20 AMP circuit.

## Standard Equipment

Part Number	Description	Individual Part Number
80C-061	Parkrimp 1 crimper with 115/230 volt, 1 phase, 60 Hz power unit wired for 115V	80C-181
●	Silver die ring	80C-R01
●	Black die ring	80C-R02

**WARNING:** This product can expose you to chemicals including Lead, which is known to the State of California to cause cancer and birth defects or other reproductive harm. For more information go to [www.p65warnings.ca.gov](http://www.p65warnings.ca.gov).

**Note:**

- For crimp instructions, see pages C-19 and C-20.
- Hose assemblies must be inspected for cleanliness and free of all foreign particles.
- Parker Hannifin will not accept responsibility for the operation of, or provide warranty coverage for, a crimper that is operated by a power unit other than equipment supplied by Parker Hannifin for the express purpose of operating the crimper.

## Capability

For use with 25, 26, 43, 81, and HY fittings.

- 1" 1 and 2 wire braided hose
- 5/8" 4 spiral hose
- 3/8" Compact Spiral Hose

No Stainless Steel Fittings

**Crimp Cycle Time:** 15-20 seconds, depending on Pusher position. (1/2" 43 series straight fittings)

**Note:** Cycle times vary depending on hose, fitting styles and sizes.

This machine may require the use of the Molykote GN grease for larger hose and fittings. For best performance and longevity of crimper components, use the Molykote GN grease for all crimping.

This machine is designed to make about 200 crimps per day and is not designed for production use. Exceeding the suggested production amounts will significantly reduce the life expectancy of the machine components.

**80C-061 Includes:**

- Parkrimp 1 Crimper
- Die ring Silver
- Die ring Black
- No Dies - Order Separately





# Parkrimp 2



[view on web page](#)

A

B

C

D

E

## Capability

- Up to 2" ID 2 wire braided hose
- Up to 2" ID 4/6 wire spiral hose\*

## Features

- Now comes standard with KrimpNODE  
See page C-6 for more information on KrimpNODE™
- Easy to use vertical design
- Crimps full range of Parker hoses from 1/4" through 2" I.D.\*
- Crimps both steel and stainless steel fittings\*
- For use with 25, 26, 43, 70, 71, 76, 77, 79, 81 and HY Series fittings

## Specifications

- Dimensions: 31" wide, 24" deep, 77" high
- Weight: 842 lbs (Head is 558 lbs and base is 284 lbs)
- Rating: 125 ton force @ 5,000 psi maximum
- Full Stroke: 30 seconds without adapter bowl
- Cycle Time: 20 seconds with adapter bowl
- Hydraulic oil: Enerpac oil

## Standard Equipment

Part Number		Description	Individual Part Number
83C-081	83C-082		
●	●	Parkrimp 2 Crimper Head Assembly	83C-080
●		Parkrimp 2 Stand Assembly with 230/460 volt, 3 phase, 50/60 Hz power unit (wired for 230 volt)	83C-S40
	●	Parkrimp 2 Stand Assembly with 230 volt, 1 phase, 50/60 Hz power unit	83C-S20
●	●	Adapter Bowl	83C-OCB
●	●	Spacer Ring	83C-R02
●	●	Spacer Plate	83C-R02H

\*Can crimp 77 Series stainless steel fittings up to 1-1/2"





## Optional Tooling

- Die Kit PK2-KDA (Includes 43 Series dies in sizes 1/4", 3/8", 1/2", 3/4", 1", 1-1/4" and 77 Series dies in sizes 1/2", 5/8", 3/4", 1", 1-1/4", 1-1/2" and 2" only)
- Die Kit 77K-KDA (Includes 77 Series dies in sizes 1/2", 5/8", 3/4", 1", 1-1/4", 1-1/2" and 2" only)

**WARNING:** This product can expose you to chemicals including Lead, which is known to the State of California to cause cancer and birth defects or other reproductive harm. For more information go to [www.p65warnings.ca.gov](http://www.p65warnings.ca.gov).

**Note:**

- For crimp instructions, see pages C-19 and C-20.
- Hose assemblies must be inspected for cleanliness and free of all foreign particles.
- Parker Hannifin will not accept responsibility for the operation of, or provide warranty coverage for, a crimper that is operated by a power unit other than equipment supplied by Parker Hannifin for the express purpose of operating the crimper.

 Parker Hannifin Corporation Hose Products Division 30240 Lakeland Blvd. Wickliffe, Ohio 44092		Parkrimp 2 Hose Die Selection Chart									
Fitting Series	HOSE	-4 RED	-5 PUR	-6 YEL	-8 BLU	-10 ORG	-12 GRN	-16 BLK	-20 WHT	-24 RED	-32 GRN
	Die Part Number	80C-A04	80C-A05	80C-A06	80C-A08	80C-A10	80C-A12	80C-A16	80C-A20	83C-A24	83C-A32
43 Series	GLOBAL CORE 187/187ST/TC (-8 THRU -32) 387/387ST/TC (-4 THRU -16) 487/487ST/TC (-4 THRU -12) 787/787ST/TC (-4 AND -6) 797/797ST/TC (-4 AND -6)	0.645	0.710	0.825	0.945	1.060	1.245	1.590	1.970	2.290	2.735
	351ST/TC 422 426 431 436 451ST/TC 471ST/TC 472TC/LT 482ST/TC	0.665	0.730	0.845	0.965	1.080	1.265	1.610	1.990	2.310	2.755
	Tooling Required										
	GLOBAL CORE 387/387ST/TC (-20 ONLY) 487/487ST/TC (-16 ONLY) 722/722ST/TC (-6 THRU -16)	0.685	0.750	0.865	0.985	1.100	1.285	1.630	2.010	2.330	2.775
	302 421WC 722LT (-6 THRU -20) 881 722ST/TC (-20 ONLY)	0.705	0.770	0.885	1.005	1.120	1.305	1.650	2.030	2.350	2.795
	Tooling Required										
NOTES		Crimp Diameter range for 722/722LT/ST/TC Size -16 is 1.630/1.660. Crimp Diameter range for 722/722LT/ST/TC Size -20 is 2.010/2.040.									
71 Series	Die Part Number			83C-D06	83C-D08	83C-D10	83C-D12	83C-D16	83C-D20	83C-D24	83C-D32
	721/721ST/TC			0.950	1.100	1.220	1.355	1.695	2.025	2.290	2.775
	722/722ST/TC/LT (-24 AND -32 ONLY)			0.970	1.120	1.240	1.375	1.715	2.045	2.310	2.795
Tooling Required											
77 Series	Die Part Number				80C-CS08	80C-CS10	80C-CS12	83C-CS16	83C-CS20	83C-CS24	83C-CS32
	GLOBAL CORE 387/387ST/TC (-20 THRU -32) 787/787ST/TC				0.930	1.057	1.245	1.541	1.970	2.320	2.865
	487/487ST/TC (-20 THRU -32) 797/797ST/TC				0.950	1.077	1.265	1.561	1.990	2.340	2.885
	Tooling Required										
NOTES		Crimp Diameter range for 387/387ST/TC Size -32 is 2.860/2.885. 77 SERIES SIZE -32 STAINLESS STEEL FITTINGS CAN NOT BE CRIMPED ON THIS MACHINE.									
25 Series	Die Part Number			80C-Y06	80C-Y08						
	271			0.680	0.825						
Tooling Required											
26 Series	Die Part Number	80C-E04	80C-E05	80C-E06	80C-E08	80C-E10	80C-E12	80C-E16	83C-E20	83C-E24	83C-E32
	213 285 293	0.460	0.520	0.575	0.670	0.805	0.915	1.175	1.420	1.670	2.160
	Tooling Required										
	201 225 266 206 226 SS25UL 221FR 244	0.500	0.560	0.615	0.710	0.845	0.955	1.215	1.460	1.710	2.200
	Tooling Required										
81 Series	Die Part Number						80C-V12	80C-V16	80C-V20	83C-V24	83C-V32
	811 811HT 881						1.155	1.450	1.740	2.010	2.430
Tooling Required											
HY Series	Die Part Number	80C-H595		80C-H735	80C-H860	80C-H1015	80C-H1170				
	611HT	0.575		0.720	0.860	0.995	1.140				
	Tooling Required										
	Die Part Number	80C-H595				80C-H1015	80C-H1170	80C-H1365			
	801 836	0.575				0.995	1.140	1.350			
	Tooling Required										
Die Part Number			80C-H735	80C-H860							
801 836			0.755	0.890							
Tooling Required											
Caution: Read the operations and technical manual before attempting to operate this machine. Do not operate this machine without guard in place. Keep hands clear of moving parts when operating machine.						Note: Stainless steel crimp diameters may be up to 0.010" greater than table listings. Do not use lubricant to assemble spiral hose and fittings.					
 83C-R12 Split Die ring is used for all crimping operations	 80C-xxx/83C-xxx small dies and 83C-OCB adapter bowl used on sizes 4 thru -20	 83C-R02 Spacer Ring used with adapter bowl when called out above	 83C-xxx Large dies used on sizes -16 thru -32	 83C-R02H Spacer Plate used when called out above							
Information on this decal is subject to change without notice. For the most current crimp specifications, please visit Crimpsource at <a href="http://www.parker.com/crimpsource">www.parker.com/crimpsource</a> . New decals can be ordered at Parker website <a href="https://parker.op.imtco.com/Account/Login">https://parker.op.imtco.com/Account/Login</a> .								Decal Part Number: 83C-CRIMPDECAL REV. J			

A

B

C

D

E

**WARNING:** This product can expose you to chemicals including Lead, which is known to the State of California to cause cancer and birth defects or other reproductive harm. For more information go to [www.p65warnings.ca.gov](http://www.p65warnings.ca.gov).

# TH8-380



[view on web page](#)

Shown with optional QDS239S front die rack

## Capability

- Up to 3" ID 2 wire braided hose
- Up to 3" ID 4/6 wire spiral hose
- Up to 4" (6")\* industrial hoses

## Features

- Electronic display preloaded with Parker part numbers and crimp specifications
- Greaseless die design

## Specifications

- Dimensions: 47"L x 24-1/2" W x 67" H
- Weight without oil: 1653 lbs
- Weight with oil: 1852 lbs
- Crimp Force: 340 Ton
- Electrical Power\*: 230-480 V / 50/60 Hz / 3PH / 5 HP
- Crimp Range: 165 mm
- Opening: 70 mm
- Opening without dies: 215 mm
- Full Cycle Time (mm/s):
  - Close: 23 (mm/s)
  - Crimp Force: 1.3 (mm/s)
  - Open: 33 (mm/s)
- Hydraulic Oil: ISO Grade AW46: 26.5 gal.  
Prefiltered oil required
- Noise Level: 62 dBA

Delivered without oil and connecting plug

## Standard Equipment

Description	Part Number
Production Crimper**	TH8-380
<b>Crimper Accessories</b>	
Adapter die	237.239.2L2
Automatic Depth Stop	TAHM3xxCA
Front Die Rack	QDS239S
Mobile Die Rack (Wheels)	QDS239C
Bench Top Die Rack	QDS239R
Foot Switch	PS.2 Double
Mirror	SHS 375/380
Quick Change Tool	QDC239.5
Workplace Lamp	LUS
<b>Available Die Sizes</b>	
PB239***	14, 17, 20, 24, 26, 28, 31, 34, 38, 40, 44, 50, 54
PB237L	57, 62, 69, 74

\*Without Flange

\*\*TH8-380 includes QDC239.5 quick change tool

\*\*\*PB239 dies require adapter die 237.239.2L2

\*Machine is factory wired to operate at high voltage. Can be field converted to operate at low voltage.

**WARNING:** This product can expose you to chemicals including Lead, which is known to the State of California to cause cancer and birth defects or other reproductive harm. For more information go to [www.p65warnings.ca.gov](http://www.p65warnings.ca.gov).

# TH8-380

## Hose Die Selection Chart

Fitting Series	Hose Size Range										
	-4	-5	-6	-8	-10	-12	-16	-20	-24	-32	-40
43 Series	17	17	20	24	26	31	40	50	57	69	78
70 Series			24	28	31						
71 Series			24	28	31	34	40	50	57	69	
77 Series				24	26	31	38	50	57	69	
79 Series						34	44	54	62		
HY Series	14	17	17	20	24	28	34	44			

### Die Chart

Size (mm)	Part Number
14	PB239-50-14
17	PB239-65-17
20	PB239-65-20
24	PB239-65-24
26	PB239-65-26
28	PB239-80-28
31	PB239-80-31
34	PB239-80-34
38	PB239-80-38
40	PB239-80-40
44	PB239-80-44
50	PB239-100-50
54	PB239-100-54
57	PB237L-57
62	PB237L-62
69	PB237L-69
74	PB237L-74
78	PB237L-78

All PB239-xx dies require the use of adapter die (Part number 237.239.2L2)

### 26 Series Die Chart

Size	Part Number
S26-04	PB239-S26-04
S26-05	PB239-S26-05
S26-06	PB239-S26-06
S26-08	PB239-S26-08
S26-10	PB239-S26-10
S26-12	PB239-S26-12
S26-16	PB239-S26-16
S26-20	PB239-S26-20
S26-24	PB239-S26-24
S26-32	PB237L-S26-32

All PB239-xx dies require the use of adapter die (Part number 237.239.2L2)

### 81 Series Die Chart

Size	Part Number
S81-12	PB239-S81-12
S81-16	PB239-S81-16
S81-20	PB239-S81-20
S81-24	PB239-S81-24
S81-32	PB237L-S81-32

All PB239-xx dies require the use of adapter die (Part number 237.239.2L2)



**QDS239.5**  
(included with machine)

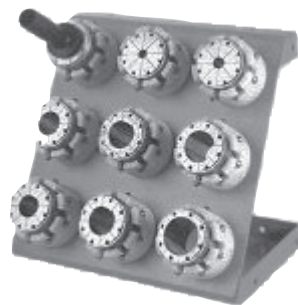

**QDS239R**  
(optional item)

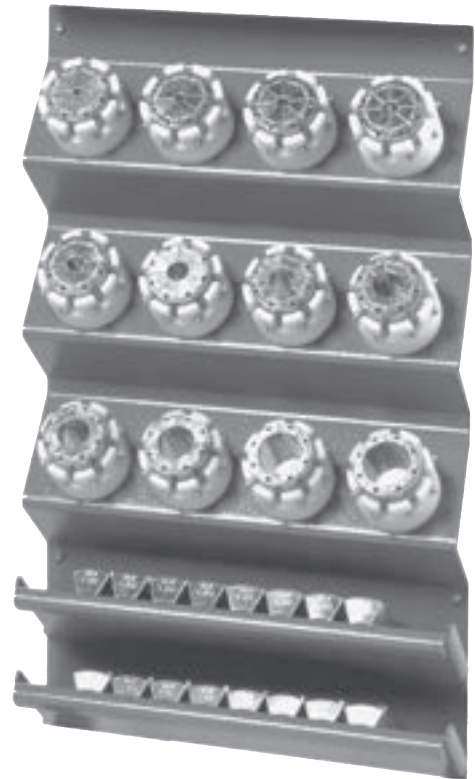

**QDS239S**  
(optional item)

**WARNING:** This product can expose you to chemicals including Lead, which is known to the State of California to cause cancer and birth defects or other reproductive harm. For more information go to [www.p65warnings.ca.gov](http://www.p65warnings.ca.gov).



## Weatherhead Conversion Kit

Part No. 8WC-001

For use with 43 Series dies only.



[view on web page](#)

Convert **Weatherhead T-400 crimper** to utilize Parker Parkrimp No-Skive fittings.

### Standard Equipment

Part Number 8WC-001	Description	Individual Part Number
●	Bowl Assembly	8PC-030
●	Pusher	8WC-00P
●	Silver Die Ring	81C-R01
●	Black Die Ring	81C-R02
●	43 Series Dies in 1/4", 3/8", 1/2" and 3/4"	80C-Axx

## Hand Pump\*

Part No. 82C-0HP



[view on web page](#)

*(for use with the Minikrimp, Karrykrimp and Karrykrimp 2)*  
Ease of operation hand pump delivers 10,000 psi

Length: 23"  
Width: 4"  
Height: 5"  
Port Size: 3/8" NPTF  
Weight: 9 lbs  
Hydraulic Fluid: Enerpac oil

## Hand Pump\*

Part No. 85C-0HP



[view on web page](#)

*(for use with the Minikrimp, Karrykrimp and Karrykrimp 2)*  
Ease of operation hand pump delivers 10,000 psi

Length: 29"  
Width: 13"  
Height: 11"  
Port Size: 3/8" NPTF  
Weight: 61 lbs  
Hydraulic Fluid: Enerpac oil

**WARNING:** \*This product can expose you to chemicals including Lead, which is known to the State of California to cause cancer and birth defects or other reproductive harm. For more information go to [www.p65warnings.ca.gov](http://www.p65warnings.ca.gov).

### Enerpac Warranty Statement

Enerpac products are warranted to be free of defects in materials and workmanship. Any product that does not conform to specification will be repaired or replaced at Enerpac's expense, anywhere in the world; simple as that! This warranty does not cover ordinary wear and tear, abuse, misuse, alterations, or the use of improper fluids. Determination of the authenticity of a warranty claim will be made only by Enerpac or its Authorized Service Centers.

### Electric Pump\*

Part No. 82C-0EP

*(for use with the Minikrimp, Karrykrimp and Karrykrimp 2)*  
Ease of operation electric pump delivers 10,000 psi



[view on web page](#)

Length: 13"  
Width: 13"  
Height: 15"  
Port Size: 3/8" NPTF  
Weight: 31 lbs  
Hydraulic Fluid: Enerpac oil  
Power Source: 115 volt, 1 phase, 50/60 Hz, 9 amp

### Electric Pump\*

Part No. 85C-0EP



[view on web page](#)

*(for use with the Minikrimp, Karrykrimp and Karrykrimp 2)*  
Heavy duty electric pump delivers 10,000 psi at a faster cycle time

Length: 19"  
Width: 11"  
Height: 17"  
Port Size: 3/8" NPTF  
Weight: 59 lbs  
Hydraulic Fluid: Enerpac oil  
Power Source: 115 volt, 1 phase, 50/60 Hz, 20 amp

### Air/Hydraulic Pump\*

Part No. 82C-0AP



[view on web page](#)

*(for use with the Minikrimp, Karrykrimp and Karrykrimp 2)*  
Lightweight pump operates with 80-110 psi shop air pressure and delivers 10,000 psi

Length: 15"  
Width: 6"  
Height: 6"  
Intake Port Size: 1/4" NPTF  
Output Port Size: 3/8" NPTF  
Weight: 14 lbs  
Hydraulic Fluid: Enerpac oil

**WARNING:** \*This product can expose you to chemicals including Lead, which is known to the State of California to cause cancer and birth defects or other reproductive harm. For more information go to [www.p65warnings.ca.gov](http://www.p65warnings.ca.gov).

#### Enerpac Warranty Statement

Enerpac products are warranted to be free of defects in materials and workmanship. Any product that does not conform to specification will be repaired or replaced at Enerpac's expense, anywhere in the world; simple as that! This warranty does not cover ordinary wear and tear, abuse, misuse, alterations, or the use of improper fluids. Determination of the authenticity of a warranty claim will be made only by Enerpac or its Authorized Service Centers.



# www.parker.com/crimpsource

Crimpsource is the industry's most complete resource for crimper technical information. It contains all of the crimp specifications approved for Parker's rubber, industrial and thermoplastic hose:

- Crimp specs
- PDFs of technical manuals for easy downloading
- Parts lists
- Troubleshooting advice
- PDFs of crimper decals for immediate printing

Crimpsource provides easy access to all the specifications necessary to correctly fabricate a factory quality hose assembly.

A series of dropdown menus enables users to find what they need quickly and easily.

Choose your crimper, and then select the hose, fittings and current specifications needed to make hose assemblies.

You can also print a simple-to-follow data specification sheet or crimper decal.



Crimpsource Home Page



**Parker** Crimp Specification Hose Products Division \*All units in inches

Hose Style: **387/387ST/TC**    Coupling Style: **43**    Crimper: **Karrykrimp 2**    Hose Description: **GlobalCore Hydraulic Hose 21 MPa/3000 psi Constant Working Pressure**

Size	CrimperDie	Die Ring	Crimp Diameter	Crimp Length	Hose Insertion	Drawing
<b>Parker 43 Series Dies</b>						
-4	80C-A04		85C-R01 0.655	FULL	0.81	PkFull
-6	80C-A06		85C-R01 0.835	FULL	1.13	PkFull
-8	80C-A08		85C-R01 0.955	FULL	1.31	PkFull
-10	80C-A10		85C-R01 1.070	FULL	1.56	PkFull
-12	80C-A12		85C-R01 1.255	FULL	1.50	PkFull
-16	80C-A16		85C-R01 1.600	FULL	1.75	PkFull
-20	80C-A20		85C-R02 2.020	FULL	1.88	PkFull

## Crimping using Minikrimp, Karrykrimp 2 and Karrykrimp 2 Bench Mount

Parkrimp Fittings Series 25, 26, 43, 70, 71, 77, 81, HY

### 1 Mark insertion depth and push on fitting

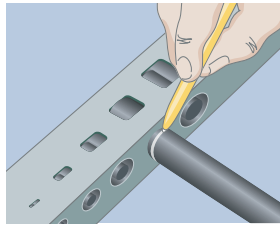

Mark the hose insertion depth and push hose into fitting until the mark on the hose is even with the end of the shell. Lubricate hose if necessary, however, **DO NOT lubricate if using spiral hose**. See Hose Insertion Depth table below.



Place shell onto end of hose and make sure the end of the shell lines up with the Insertion Depth mark.

Push hose onto the 88 Series fitting until the shell bottoms against the fitting's stop ring or hex. Lubricate hose if necessary.

### 2 Insert unitized die train



Pull pin at the top of pusher to swing it back. Place unitized die-train into base plate. See decal on crimping machine for proper die set.

**Important:** Lubricate the crimping machine's die bowl using a premium quality lithium-base grease.

Color-Coded Unitized Die-Train

### 3 Position the fitting

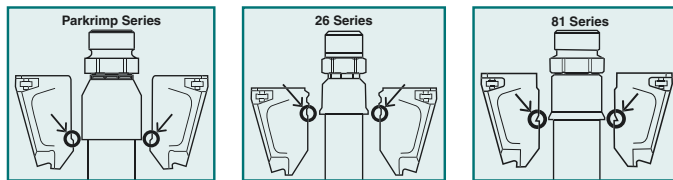

Position the hose and fitting in dies from below. Rest bottom of coupling on die step using the PARKALIGN® feature.

### 4 Place die ring and crimp



Place correct die ring on top of the dies. See decal on crimping machine for proper die ring.



Position pusher by replacing the pin and operate pump until the die ring bottoms out. Release pressure within the pump — remove finished assembly.

**Note:** Minikrimp, Karrykrimp & Karrykrimp 2 have several types of power sources, all of which are separate units from the crimping machine.

### 5 Measure crimp diameter

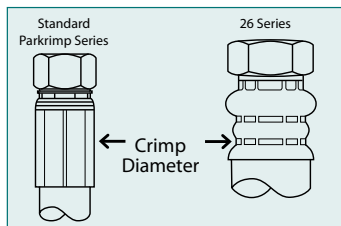

Measure crimp diameter on the flat surfaces of the crimped shell, referenced in the illustration to the left. Reference decal on crimping machine for crimp diameters. Never use hose assemblies with incorrect crimp diameters.

**Important:** Hose assemblies must be inspected for cleanliness and free of all foreign particles.

### Hose insertion depths

Fitting Size	Fitting Series																		
	25		26		43		70		71		77		79		81		HY		
	inch	mm	inch	mm	inch	mm	inch	mm	inch	mm	inch	mm	inch	mm	inch	mm	inch	mm	
-4	-	-	0.81	21	0.81	21	-	-	-	-	-	-	-	-	-	-	-	1.38	35
-5	-	-	0.81	21	0.94	24	-	-	-	-	-	-	-	-	-	-	-	1.41	36
-6	0.88	22	0.81	21	1.13	29	1.06	27	1.06	27	-	-	-	-	-	-	-	1.35	34
-8	0.88	22	0.81	21	1.31	33	1.31	33	1.25	32	1.36	34,6	-	-	-	-	-	1.44	37
-10	-	-	0.88	22	1.56	40	1.38	35	1.31	33	1.53	38,9	-	-	-	-	-	1.46	37
-12	-	-	0.88	22	1.50	38	1.50	38	1.44	37	1.78	45,2	2.18	56	1.12	29	1.55	39	
-16	-	-	1.00	25	1.75	44	1.81	46	1.75	44	2.13	54,1	2.31	59	1.25	32	1.69	43	
-20	-	-	1.00	25	1.88	48	1.75	44	1.81	46	2.51	63,8	2.81	71	1.31	33	-	-	
-24	-	-	1.06	27	1.44	37	-	-	2.31	59	2.67	67,7	-	-	1.31	33	-	-	
-32	-	-	1.25	32	1.81	46	-	-	2.44	62	3.05	77,5	-	-	1.69	43	-	-	

For specific information on crimping, visit Crimpsource™ online at [www.parker.com/crimpsource](http://www.parker.com/crimpsource).



## Crimping using Parkrimp 2

Parkrimp Fittings Series 25, 26, 43, 70, 71, 77, 81, HY

### 1 Mark insertion depth and push on fitting

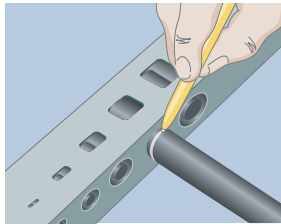

Mark the hose insertion depth and push hose into fitting until the mark on the hose is even with the end of the shell. Lubricate hose if necessary, however, **DO NOT lubricate if using spiral hose.** See Hose Insertion Depth table on previous page.

#### For 81 Series Shells with 88 Series Fittings

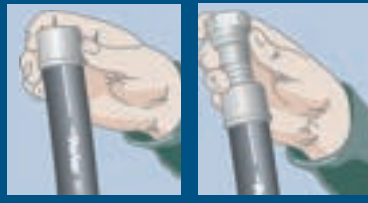

Place 81 Series Shell onto end of hose and make sure the end of the shell lines up with the Insertion Depth mark.

Push hose onto the 88 Series fitting until the shell bottoms against the fitting's stop ring or hex. Lubricate hose if necessary.

### 2a If using large two-piece dies

Insert the proper die set into the die bowl. (The die sets are in two halves of four dies each. Place one half in the back and one half in the front to accommodate bent tube fittings.) Reference decal on crimper for proper tool selection.

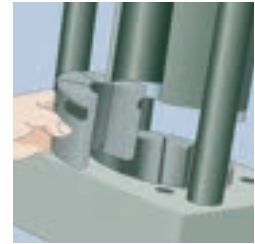

### 2b If using small unitized dies

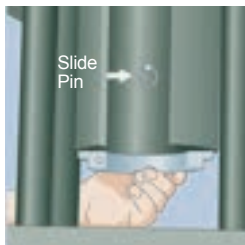

With the pusher in the full up position, lift the back half of the split die ring. Lock it in the up position by pushing the slide pin in. (The slide pin is located inside the pusher at the back.)

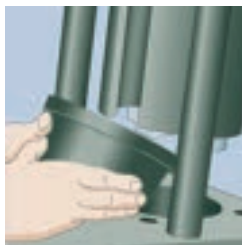

Lubricate die bowl using a premium quality lithium-base grease. Carefully insert the adapter bowl, 83C-OCB, into the base bowl. The adapter bowl must be tilted toward the back of the crimper during insertion.



Color-Coded Unitized Die-Train

Lubricate die bowl using a premium quality lithium-base grease. Place unitized die-train into the adapter bowl. Select die and die ring by hose size and type. See decal on crimper for proper die set.

**Note:** Die sets have color-coded cavities indicating size and have the fitting series and dash size stamped on the top.

### 3 Place spacer ring



If required, place spacer ring on locating step of adapter bowl. Reference decal on crimper for tool selection.

### 4 Position the split die ring



Lower the back half of the split die ring onto the dies by pulling the slide pin forward.



Insert the front half of the split die ring aligning the pins in the back half with the hole in the front half.

### 5 Position the fitting

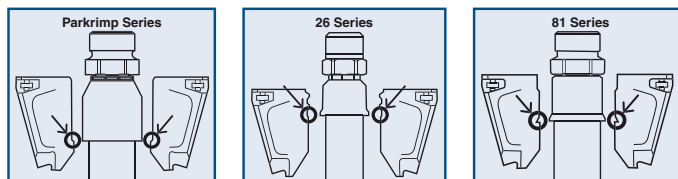

Position the hose and fitting in dies from below. Rest bottom of coupling on die step using the PARKALIGN® feature.

### 6 Crimp hose

Turn on the pump by pressing the "ON" switch. Pull the valve handle forward to bring the pusher down for crimping. When the split die ring contacts the base plate, the crimp is complete. Push the valve handle back to lift the pusher, open the dies, and release the finished assembly.

**Note:** You do not have to remove any tooling to insert or remove straight fittings. The front half of the split die ring and the front die train must be removed to insert and remove bent tube fittings.



### 7 Measure crimp diameter

Measure crimp diameter on the flat surfaces of the crimped shell, referenced in the illustration to the right. Reference decal on crimper for crimp diameters. Never use hose assemblies with incorrect crimp diameters.

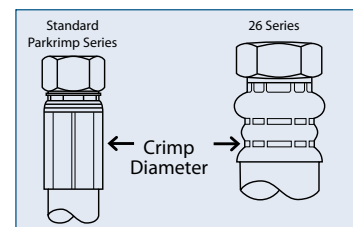

**Important:** Hose assemblies must be inspected for cleanliness and free of all foreign particles.

# Assembling Twin Tough Rubber Hose

## Required Equipment:

Twin Tough hose, fittings, knife, tape measure, heat shrink sleeve, scissors, grease pencil, heat gun, and calipers.



## Set-up:

Position the bonded rubber hose so that it lies flat on a work surface without tendency to twist or turn.

**Measure hose tear back length:** Measure and mark the length that the hoses are to be separated. A minimum of 12 inches is required for crimping the hose ends. A 24 inch tear back is recommended for use with hydraulic tools.



Note: If length of separation/tear back is specified from the threaded or swivel nut end of the coupling, then deduct the cut off allowance dimension for the specific style of coupling used. The cutoff allowance can be obtained from the hose fitting tables in the 4400 Catalog "B" dimension, or can be calculated by subtracting the insertion depth of the shell from the overall coupling length.

## Cut hose tear back to length:

Press the bonded hose assembly firmly and flat against the work surface with your free hand so that it does not move.

A.) Using a sharp blade, pierce the center of the valley (web) formed by the hoses.



B.) To start the cut, place the blade in the center of that valley (web) drawing the knife with constant pressure.



C.) Once you have a 1 to 2 inch starter cut, firmly pull each hose end apart to your required separation length.



Note: It is important that the knife blade be perpendicular to the hose during this procedure so the blade cuts only the centerline of the valley (web). **EXTREME CARE MUST BE TAKEN TO AVOID CUTTING THROUGH THE COVER OF THE HOSES AND THEREBY EXPOSING THE HOSE REINFORCEMENT.** If this occurs, the hose assembly must be discarded.

A

B

C

D

E

**Measure Separation:** It is suggested that the separation length be at least 12 inches, so the crimping operation can be accomplished without risk of kinking the hoses.



**Stopping Separation:** Parker recommends installing a heat shrink sleeve of at least 2 inches in length at the termination of the separated hose to provide protection against tearing of the valley (web) or hose covers. This heat shrink sleeve should be placed on the hose assembly prior to the crimping of the hose fittings. Once you have your heat shrink sleeve in place, use a heat gun to shrink the sleeve in place.



Note: EXTREME CARE MUST BE TAKEN TO AVOID EXPOSING THE HOSE ASSEMBLY TO THE DIRECT HIGH TEMPERATURES OF THE HEAT GUN WHILE INSTALLING THE HEAT SHRINK SLEEVE. LONG EXPOSURE FROM A HEAT GUN MAY ADVERSELY AFFECT THE HOSE INNER TUBE OR ITS COVER.

**Crimping Fittings:** All of your crimping information can be found on Crimpsource ([www.parker.com/crimpsource](http://www.parker.com/crimpsource)).

First, place your fittings onto each hose end making sure that both have been installed to the correct hose insertion depth. Choose the correct die and die rings. Place half of your hose assembly through the bottom of your Parkrimp crimper. Rest the bottom of the fitting on the die step using the Parkalign system. While lightly holding the hose assembly, operate your crimper pump so that the pusher on the crimper comes down in contact with the die ring until it bottoms out on the crimper base. Then release the pressure within the pump and remove the first half of your finished assembly. Always measure your hose assemblies for the correct crimp diameter. Now, repeat the crimping process on the other fitting.



Note: EXTREME CARE MUST BE TAKEN TO AVOID KINKING THE HOSE THAT IS NOT BEING CRIMPED DURING THIS PROCESS.

## Hose Cut-Off Machine

Part No. 86C-220V

### Features

- Engineered for workshop, retail, or production use
- Cuts hoses with less friction, no heat, and less debris
- Vacuum port eliminates any very small amount of smoke or debris created
- Comes standard with a Parker branded advanced scallop blade
- Cuts wire reinforced hoses including 6 heavy wire constructions up to 2" ID

### Specifications

- Dimensions: 27" wide X 16.5" long X 24" high (when handle is at the highest point)
- Shipping Weight: 108 lbs



[view on web page](#)

### Standard Equipment

Part Number	Description	Individual Part Number
86C-220V		
●	Hose cut off machine with 220V single phase motor	
●	Parker branded advanced scallop blade- 10" OD x .125 THK X 40 mm arbor	HYD10X125X40

**WARNING:** This product can expose you to chemicals including Lead, which is known to the State of California to cause cancer and birth defects or other reproductive harm. For more information go to [www.p65warnings.ca.gov](http://www.p65warnings.ca.gov).

## Hose Cut-Off Machine

Part No. 86C-220V3

### Features

- Engineered for workshop, retail, or production use
- Cuts hoses with less friction, no heat, and less debris
- Vacuum port eliminates any very small amount of smoke or debris created
- Comes standard with a Parker branded advanced scallop blade
- Cuts wire reinforced hoses including 6 heavy wire constructions up to 2" ID

### Specifications

- Dimensions: 27" wide X 16.5" long X 24" high (when handle is at the highest point)
- Shipping Weight: 108 lbs



[view on web page](#)

### Standard Equipment

Part Number	Description	Individual Part Number
86C-220V3		
●	Hose cut off machine with 220V three phase motor	
●	Parker branded advanced scallop blade- 10" OD x .125 THK X 40 mm arbor	HYD10X125X40

**WARNING:** This product can expose you to chemicals including Lead, which is known to the State of California to cause cancer and birth defects or other reproductive harm. For more information go to [www.p65warnings.ca.gov](http://www.p65warnings.ca.gov).

## Hose Cut-Off Machine

Part No. TH3-EM3-110V

### Features

- Engineered for workshop or production use
- Comes with a vacuum port to remove smoke and debris while cutting
- Comes standard with a diamond-coated cutting blade
- Cuts wire reinforced hoses including 6 heavy spiral constructions up to 1 1/4" I.D.

### Specifications

- Dimensions: 17" wide, 21" long and 12" high
- Shipping Weight: 95 lbs.

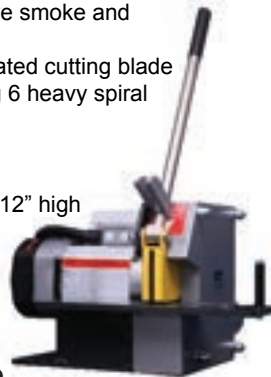

[view on web page](#)

### Standard Equipment

Part Number	Description	Individual Part Number
TH3-EM3-110V		
●	Hose cut-off machine with 110V single phase motor	
●	Industrial diamond coated cutting blade	TM-V
	Cutting blade with inclined slots	TM-G
	Flat cutting blade	TM-F

**WARNING:** This product can expose you to chemicals including Lead, which is known to the State of California to cause cancer and birth defects or other reproductive harm. For more information go to [www.p65warnings.ca.gov](http://www.p65warnings.ca.gov).

A

B

C

D

E

## Hose Cut-Off Machine

Part No. 332T-115V

### Features

- For quick, easy cutting of spiral reinforced hose up to 1-1/4" I.D.
- Moving parts shielded by guards

### Specifications

- Dimensions: 13" wide x 26" long x 22" high
- Shipping Weight: 71 lbs.

### Optional Equipment

- Smooth Cutting Blade (580661)

### Standard Equipment



[view on web page](#)

Part Number 332T-115V	Description	Individual Part Number
●	Hose Cut-Off Machine with 1-1/2 HP, 3450 RPM, 115V single phase electric motor.	
●	Scallop Cutting Blade (8" with 5/8" arbor size)	24398

**WARNING:** This product can expose you to chemicals including Lead, which is known to the State of California to cause cancer and birth defects or other reproductive harm. For more information go to [www.p65warnings.ca.gov](http://www.p65warnings.ca.gov).

## Hose Cut-Off Machine

Part No. 239 and 339

### Features

- Designed for heavy duty use
- Cuts multi-braided wire reinforced hose including 6 spiral construction up to 2" I.D.

### Specifications

- Dimensions: 22" wide x 42" long x 24" high
- Shipping Weight: 115 lbs.

### Optional Equipment

- Smooth Cutting Blade (15960)

### Standard Equipment



[view on web page](#)

Part Number		Description	Individual Part Number
239	339		
●		Hose Cut-Off Machine with 230V single phase motor	
	●	Hose Cut-Off Machine with 3 HP motor 230V, 3 phase, 60 cycle	
●	●	Scallop Cutting Blade (10" with 3/4" arbor size)	24248

**WARNING:** This product can expose you to chemicals including Lead, which is known to the State of California to cause cancer and birth defects or other reproductive harm. For more information go to [www.p65warnings.ca.gov](http://www.p65warnings.ca.gov).

A

B

C

D

E

## Premium Hose Cleaning Kit



[view on web page](#)

Part No. TH6-10-HL-10-2 (10 Nozzle Kit)

## Economy Hose Cleaning Kit



[view on web page](#)

Part No. TH6-10-EL-8 (8 Nozzle Kit)

### Features

- Capable of cleaning 1/4" through 2" hose, tube or pipe
- The launcher is supplied with a Full-Flow Quick Release Coupling and unique 360° Rotary Plug for proper air flow and non-fatigue operator use
- Unique Safety Release Bar that locks the faceplate into a closed position for firing Ultra Clean projectiles

### Nozzles Included in Kits

End Type	Size	Nozzle Part Number*	Projectile Part Number†	Projectile Quantity†
Hose	1/4"	TH6-10-H06	TH6-10-P10	100
Hose	5/16"	TH6-10-H08	TH6-10-P12	100
Hose	3/8"	TH6-10-H10	TH6-10-P14	100
Hose	1/2"	TH6-10-H13	TH6-10-P18	100
Hose	5/8"	TH6-10-H16	TH6-10-P22	50
Hose	3/4"	TH6-10-H19	TH6-10-P26	50
Hose	1"	TH6-10-H25	TH6-10-P33	40
Hose	1-1/4"	TH6-10-H32	TH6-10-P40	30
Hose	1-1/2"	TH6-10-H38	TH6-10-P50	20
Hose	2"	TH6-10-H50	TH6-10-P60	15

\*Nozzles are not available individually

†Projectiles sold separately

### Additional Available Nozzles

End Type	Size	Nozzle Part Number	Projectile Part Number†	Projectile Quantity†
JIC	1/4"	TH6-10-J06	TH6-10-P06	100
JIC	3/8"	TH6-10-J10	TH6-10-P12	100
JIC	1/2"	TH6-10-J13	TH6-10-P16	100
JIC	5/8"	TH6-10-J16	TH6-10-P22	50
JIC	3/4"	TH6-10-J19	TH6-10-P26	50
JIC	1"	TH6-10-J25	TH6-10-P33	40
JIC	1-1/4"	TH6-10-J32	TH6-10-P40	30
JIC	1-1/2"	TH6-10-J38	TH6-10-P50	20
JIC	2"	-	TH6-10-P60	15

†Projectiles sold separately

### Features

- Capable of cleaning 1/4" through 1-1/4" hose, tube or pipe
- Has a quarter-turn locking ring for easy nozzle change and projectile loading
- The launcher is constructed of durable brass and aluminum internals, strong plastic handle, and anodized aluminum firing head and locking ring.
- Ideal for mobile and job site applications because of its size and portability



### Air Requirements

- 80 PSI (5.5 Bar) minimum to 110 PSI (7.5 Bar) maximum
- 1/2" I.D. air hose
- 5 micron filter and regulator with gauge are strongly suggested
- Requires a 1/2" I.D. air hose with 80 PSI (minimum) / 110 PSI (maximum), and it is strongly recommended that you use a 5 micron filter and regulator with a gauge.

A

B

C

D

E

## Parker Clean Seal

Parker's Clean Seal cap is a simple, easy and clean alternative to cap your hose and fitting assemblies. The Clean Seal cap enables a secure fit due to an easy to use heat shrink system. Reduce your cap complexity as one Clean Seal cap will seal multiple end configurations and sizes, eliminating many unique traditional caps.

The Clean Seal process utilizes heat shrink technology to cover the end of a hose assembly. The heat shrink technology eliminates problems due to re-contamination issues. When traditional caps and plugs are forced onto assemblies, plastic debris and particles shred off into your hose, ultimately causing re-contamination.

### Product Features:

- For use on fittings up to -24 (1-1/2")
- Fits straight and elbow fittings
- Easy pull tab removal
- Reduced environmental impact compared to traditional caps
  - Less plastic used
  - More crushable
- Multiple hoses can be capped at one time



[view on web page](#)

### Cap Part Numbers

Packaged		Bulk		Sizing	
Parker P/N (Package)	Package Quantity	Parker P/N (Bulk)	Bulk Quantity	Hex Sizes Covered (in mm)	Hex Sizes Covered (in inches)
PCS-2023P	810	PCS-2023B	23,400	12mm to 18mm	.47" to .71"
PCS-2030P	810	PCS-2030B	23,400	12mm to 18mm	.47" to .71"
PCS-2224P	810	PCS-2224B	23,500	16mm to 21mm	.63" to .83"
PCS-2527P	800	PCS-2527B	17,600	18mm to 23mm	.71" to .91"
PCS-2540P	800	PCS-2540B	17,600	18mm to 23mm	.71" to .91"
PCS-2840P	720	PCS-2840B	15,200	22mm to 26mm	.87" to 1.02"
PCS-3133P	640	PCS-3133B	12,240	24mm to 29mm	.94" to 1.14"
PCS-3140P	640	PCS-3140B	12,240	24mm to 29mm	.94" to 1.14"
PCS-3440P	640	PCS-3440B	10,240	27mm to 32mm	1.07" to 1.26"
PCS-3840P	560	PCS-3840B	7,800	30mm to 36mm	1.09" to 1.42"
PCS-4345P	480	PCS-4345B	6,240	32mm to 41mm	1.26" to 1.61"
PCS-4650P	480	PCS-4650B	5,760	34mm to 44mm	1.34" to 1.73"
PCS-5260P	400	PCS-5260B	4,400	41mm to 50mm	1.62" to 1.97"
PCS-5860P	400	PCS-5860B	3,600	49mm to 56mm	1.93" to 2.20"
PCS-6760P	320	PCS-6760B	2,560	55mm to 65mm	2.16" to 2.56"

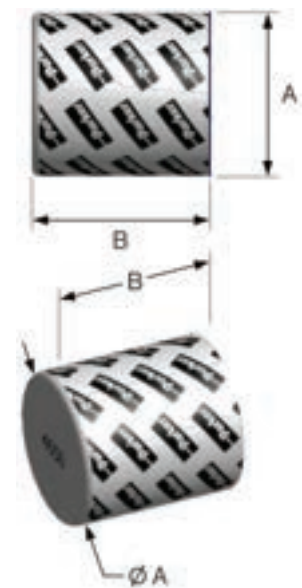

**PCS-4650B**

"A" "B" B=Bulk  
P=Package

"A" and "B" dimensions in mm. Shorter length capsules recommended for elbow/bent fittings.

### Equipment Part Numbers

UC-CSS-230V	UC-HL1910E	UC-HG-STAND	UC-1.5HD
Production Heat Shrink machine with timer 	Electric heat gun with case 	Flex vacuum pumpstand for heat gun 	95mm diffuser for 1-1/2" heat gun connection 

## Hose Cut-Off Tool - Handykut

Part No. 871522

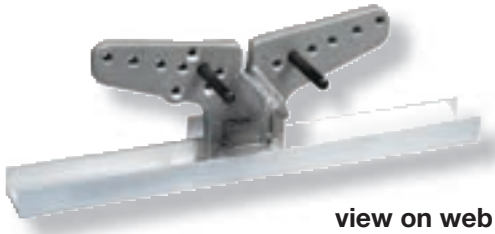

view on web page

### Features

- Portable tool for efficient cutting of hose
- Can be positioned onto a flat surface by clamps or by locking it in a vise, properly align the hose in a radius and cut it with a hacksaw

### Specifications

- Dimensions: 6" wide x 18" long x 6" high
- Shipping Weight: 10 lbs.

## Push-Lok Cut-Off & Assembly Tool

Part No. 881540



view on web page

### Features

- Combined hose cutter and toggle action press that cuts and assembles Parker Push-Lok in sizes 1/4" through 3/4" I.D.

### Specifications

- Dimensions: 16" long
- Shipping Weight: 4 lbs.

**WARNING:** This product can expose you to chemicals including Lead, which is known to the State of California to cause cancer and birth defects or other reproductive harm. For more information go to [www.p65warnings.ca.gov](http://www.p65warnings.ca.gov).

## Hose Insertion Depth Blocks

Part No. TH9-1-XXX



view on web page

### Features

- For quick easy marking of hose insertion depth
- Ensures accuracy and increased productivity

### Available Blocks

Part Number	Description
TH9-1-26A	26 Series -4 through -10
TH9-1-26B	26 Series -12 through -32
TH9-1-43A	43 Series -4 through -10
TH9-1-43B	43 Series -12 through -32
TH9-1-77	77 Series -8 through -32
TH9-1-HY	HY Series -4 through -16

**WARNING:** This product can expose you to chemicals including Lead, which is known to the State of California to cause cancer and birth defects or other reproductive harm. For more information go to [www.p65warnings.ca.gov](http://www.p65warnings.ca.gov).

## Hose Cut-Off Tool

Part No. TH11-1



view on web page

### Features

- Designed for quick, easy cutting of textile reinforced hose.
- Squarely cuts Push-Lok hose in sizes 1/4" through 3/4" I.D.

### Specifications

- Dimensions: 8" long
- Shipping Weight: 0.3 lbs.



## Hozebler

Part No. 432-115V

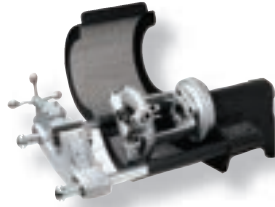

[view on web page](#)

### Features

- Power machine to facilitate the attachment of field attachable fittings
- Handles all hose and fittings up to 4 spiral wire, in sizes 3/16" through 2" I.D., including bent tube elbows
- Comes with vise, all adapters, foot switch and safety guard with 115V, 30 amp, universal AC motor

### Specifications

- Shipping Weight: 141 lbs.

### Optional Parts

- Mounting stand (662451)

**⚠ WARNING:** This product can expose you to chemicals including Lead, which is known to the State of California to cause cancer and birth defects or other reproductive harm. For more information go to [www.p65warnings.ca.gov](http://www.p65warnings.ca.gov).

## Swivel Die Rack

Part No. 80C-SDR-XXXX



[view on web page](#)

### Features

- Holds up to 30 Parkrimp dies of any size
- Powder-coated, heavy-duty steel construction
- Consists of a base unit and up to five circular holders
- Floor or bench mounted

### Standard Equipment

Part Number	Description
80C-SDR-SM	Swivel Die Rack and Small Die Holder
80C-SDR-LG	Swivel Die Rack and Large Die Holder
80C-SDR-BASE	Swivel Die Rack Base

## Die Storage Racks

Part No. 80C-0DR and 83C-0DR



[view on web page](#)

### Features

- Modular die rack designed to hold small and large Parkrimp dies
- Can be bolted together to a work bench horizontally or vertically

### Standard Equipment

Part Number		Description
80C-0DR	83C-0DR	
●		Storage of three sets of small dies
	●	Storage of two sets of large dies

## Fitting Push-On Stand

Part No. TH2-7



[view on web page](#)

### Features

- Quickly and easily pushes fittings onto hose
- Boosts productivity and quality
- Eliminates the need of rubber mallets and oils to get fittings onto the end of the hose for crimping
- Standard with straight tooling required for sizes 1/4" through 2" for all crimped fittings, 82 Series Push-Lok and 88 Series field attachable fittings

### Specifications

- Requires a minimum of 80 psi
- Shipping Weight: 200 lbs.

### Optional Tooling

- Elbow Pusher Set (TH2-7-ELS)
- -32 Monoblock Elbow Pusher Set (TH2-7-ELSH)

**⚠ WARNING:** This product can expose you to chemicals including Lead, which is known to the State of California to cause cancer and birth defects or other reproductive harm. For more information go to [www.p65warnings.ca.gov](http://www.p65warnings.ca.gov).

## Mandrel Tool Kit - 22 Series

Part No. 652200



### Features

[view on web page](#)

- For assembly of Parker 22 Series field attachable fittings
- One of each part listed below is included in the kit

### Standard Equipment

Hose I.D.	Dash Size	SAE (JIC) 37°	SAE 45°
3/16	-4	●	●
1/4	-5	●	●
5/16	-6	●	●
13/32	-8	●	●
1/2	-10	●	●
5/8	-12	●	●

**WARNING:** This product can expose you to chemicals including Lead, which is known to the State of California to cause cancer and birth defects or other reproductive harm. For more information go to [www.p65warnings.ca.gov](http://www.p65warnings.ca.gov).

## Mandrel Tool Kit - 23 Series

Part No. 2727 and 2726



### Features

[view on web page](#)

- For assembly of Parker 23 Series field attachable fittings
- Part No. 2727 is for JIC 37° flared fittings
- Part No. 2726 is for SAE 45° and PTT 30° flared fittings

### Standard Equipment

Hose I.D.	Dash Size	2727	2726
3/16	-4	●	●
1/4	-5	●	●
5/16	-6	●	●
13/32	-8	●	●
1/2	-10	●	●
5/8	-12	●	●
7/8	-16	●	●

**WARNING:** This product can expose you to chemicals including Lead, which is known to the State of California to cause cancer and birth defects or other reproductive harm. For more information go to [www.p65warnings.ca.gov](http://www.p65warnings.ca.gov).

## Mandrels - 25 Series

(For 271 Transportation Hose)

Part No. TH2-7M25-6 and TH2-7M25-8



[view on web page](#)

**WARNING:** This product can expose you to chemicals including Lead, which is known to the State of California to cause cancer and birth defects or other reproductive harm. For more information go to [www.p65warnings.ca.gov](http://www.p65warnings.ca.gov).

## Assembly Tools - 22/23 Series

Part No. 652201



[view on web page](#)

### Features

- For assembly of Parker 22/23 Series field attachable fittings
- One of each part listed below is included in the kit

### Standard Equipment

Hose I.D.	Dash Size	SAE (JIC) 37°	SAE 45°
7/8	-16	●	●
1-1/8	-20	●	●
1-3/8	-24	●	●
1-13/16	-32	●	●

**WARNING:** This product can expose you to chemicals including Lead, which is known to the State of California to cause cancer and birth defects or other reproductive harm. For more information go to [www.p65warnings.ca.gov](http://www.p65warnings.ca.gov).

A

B

C

D

E

## Hose Oil

Part No. Hose Oil



### Features

- Reduces torque and eliminates waste lubrication
- Use hose oil with the recommended hose assembly instructions

## Accrolube

Part No. Accrolube



### Features

- High efficiency lubricant used for stainless steel field attachable fittings
- Contains PTFE to reduce the wear between metal surfaces, protects against corrosion and ultimately eliminates galling

## Small Crimper Hood

Part No. 82C-CVR



### Features

- Water repellant
- UV protected
- Perfect for indoor and outdoor applications

### Fits

- Karrykrimp, Parkrimp  
Karrykrimp2, Minikrimp

[view on web page](#)

## Large Crimper Hood

Part No. 83C-CVR



### Features

- Water repellant
- UV protected
- Perfect for indoor and outdoor applications

### Fits













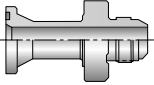
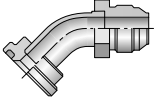
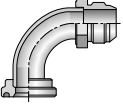
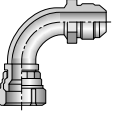

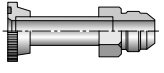
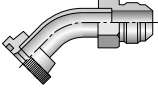
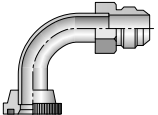
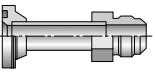
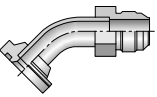
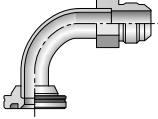
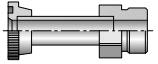
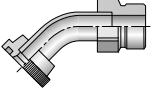
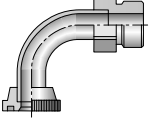
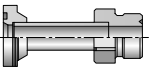
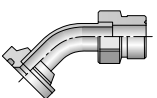
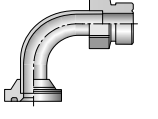
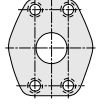
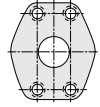
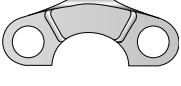

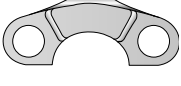

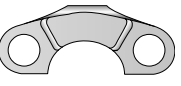

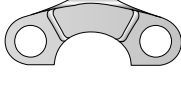
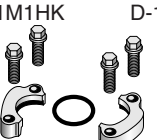

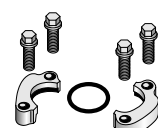

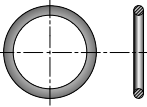
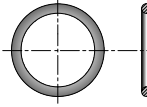
- PHastkrimp, Superkrimp  
Parkrimp2

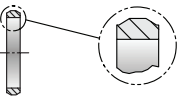





[view on web page](#)



# Accessories

[Hose Adapters](#)   [Hydraulic Flange Adapters](#)   [O-Rings](#)  
[Hose Guards](#)   [Hose Assembly Workstations](#)

A	 <p><b>Hose Adapters</b></p>		 <p><b>Hydraulic Flange Adapters</b></p>		<p>15T3 D-5</p>  <p>Code 61 - JIC 37°</p>	<p>17T3 D-5</p>  <p>Code 61 - JIC 37° 45° Elbow</p>	<p>19T3 D-5</p>  <p>Code 61 - JIC 37° 90° Elbow</p>
	<p>39T3 D-6</p>  <p>Male - Female JIC 37° - 90° Elbow</p>	<p>41T3 D-6</p>  <p>Male - Female JIC 37° 90° Elbow - Long</p>	<p>4AH3 D-6</p>  <p>Code 61 - JIC 37° 5000 psi</p>	<p>4FH3 D-7</p>  <p>Code 61 - JIC 37° 5000 psi - 45° Elbow</p>	<p>4NH3 D-7</p>  <p>Code 61 - JIC 37° 5000 psi - 90° Elbow</p>	<p>6AH3 D-7</p>  <p>Code 62 - JIC 37°</p>	
B	<p>6FH3 D-7</p>  <p>Code 62 - JIC 37° 45° Elbow</p>	<p>6NH3 D-8</p>  <p>Code 62 - JIC 37° 90° Elbow</p>	<p>4AJM D-8</p>  <p>Code 61 - Seal-Lok®</p>	<p>4FJM D-8</p>  <p>Code 61 - Seal-Lok® 45° Elbow</p>	<p>4NJM D-8</p>  <p>Code 61 - Seal-Lok® 90° Elbow</p>	<p>6AJM D-9</p>  <p>Code 62 - Seal-Lok®</p>	
	<p>6FJM D-9</p>  <p>Code 62 - Seal-Lok® 45° Elbow</p>	<p>6NJM D-9</p>  <p>Code 62 - Seal-Lok® 90° Elbow</p>	<p>Standard Pressure (Code 61) Specifications D-10</p> 	<p>High Pressure (Code 62) Specifications D-10</p> 	<p>50H D-10</p>  <p>Flange Half 5000 psi (Code 61)</p>	<p>5050HK D-11</p>  <p>Flange Kit Code 61 - 5000 psi</p>	
C	<p>51H D-11</p>  <p>Flange Half - Code 61</p>	<p>5151HK D-11</p>  <p>Flange Kit - Code 61</p>	<p>HFH D-12</p>  <p>Flange Half - Code 62</p>	<p>HFHFHK D-12</p>  <p>Flange Kit - Code 62</p>	<p>FFK61 D-13</p>  <p>Full Flange Kit</p>	<p>M1H D-14</p>  <p>Flange Half ISO - Code 61</p>	
	<p>M1M1HK D-14</p>  <p>Flange Kit ISO - Code 61</p>	<p>M2H D-15</p>  <p>Flange Half ISO - Code 62</p>	<p>M2M2HK D-15</p>  <p>Flange Kit ISO - Code 62</p>	<p>XCXCHK D-15</p>  <p>Flange Kit - CAT</p>	 <p><b>O-Rings</b></p>		<p>EFS D-16</p>  <p>Engineered Flange Seal</p>
D	<p>711509 D-17</p>  <p>O-Rings SAE Thread</p>	<p>711510 D-17</p>  <p>O-Rings Code 61/Code 62</p>	<p>D9DT D-17</p>  <p>Bonded Seal for BSPF Port Fittings</p>	<p>J0RG D-18</p>  <p>O Rings - Seal-Lok®</p>	<p>XARG D-18</p>  <p>Flange "D" Rings CAT</p>	<p>59RG D-19</p>  <p>O-Rings - Tube O-Ring &amp; Compressor Fittings</p>	
	<p>T1RG D-19</p>  <p>O-Rings Compression Fittings (IT126)</p>	<p>CORG D-19</p>  <p>O-Ring Assembly Tools</p>	 <p><b>Hose Guards</b></p>		<p>Partek Defense D-20</p> 	<p>Partek Wrap D-21</p> 	<p>Partek Sleeve D-22</p> 
E							<p>Partek Sleeve D-22</p> 

<p>PolyGuard (HG) D-22</p> 	<p>ParKoil™ (PG) D-22</p> 	<p>Spring Guard (SG) D-23</p> 	<p>Polyguard Strain Reliever D-23</p> 	<p>Firesleeve (FS-F) D-24</p> 	<p>FSC Clamp D-24</p> 	
<p>Firesleeve Tape D-24</p> 	<p>Protection Shields D-25</p> 	<p>Hose Whip Restraint D-33</p> 	<p>CL Clamp D-37</p> 	<p>HC Clamp D-38</p> 	<p>88HC-H Wormgear D-38</p> 	
<p>88DB Clamp D-38</p> 	<p><b>Hose Assembly Workstations</b></p> 		<p>Hose Assembly Workstations D-39</p> 	<p>HoseFab Table D-40</p> 	<p>Rotary Reel Rack D-40</p> 	<p>Saw Table D-40</p> 
<p>3/4 Reel Rack D-40</p> 	<p>Parker Kart D-41</p> 	<p>72B-Cabinet D-41</p> 	<p>HR6 Hose Bin D-41</p> 			

A

B

C

D

E

# SAE/NPT/Metric Hose Adapters



**O-Ring Face-Seal Seal-Lok™**

Sizes: 6 mm – 38 mm  
Materials: Steel, Stainless Steel  
Pressures: Up to 9200 psi

**O-Ring Face-Seal Metric Seal-Lok™**

Sizes: 1/4" – 2"  
Materials: Steel, Stainless Steel  
Pressures: Up to 9200 psi

**37° Flare Fittings Triple-Lok®**

Sizes: 1/8" – 2"  
Materials: Steel, Stainless Steel, Brass  
Pressures: Up to 9000 psi

**37° Flare Metric Triple-Lok®**

Sizes: 6 mm – 38 mm  
Materials: Steel, Stainless Steel  
Pressures: Up to 7200 psi

**Pipe Fittings and Port Adapters**

Sizes: 1/8" – 2"  
Materials: Steel, Stainless Steel, Brass  
Pressures: Up to 7200 psi

**Conversion Adapters**

Sizes: 1/4" – 1-1/2"  
Materials: Steel, Stainless Steel  
Pressures: Up to 7700 psi



**Pipe Swivels**

Sizes: 1/8" – 2"  
Materials: Steel, Stainless Steel  
Pressures: Up to 5000 psi

**Hydraulic Flange and Flange Adapters**

Sizes: 3/4" – 3"  
Materials: Steel, Stainless Steel  
Pressures: Up to 6000 psi

**Japanese Industrial Standard JIS**

Sizes: 1/4" – 1"  
Materials: Steel  
Pressures: Up to 5000 psi

**30° Flare Komatsu Style**

Sizes: M14 x 1.5 – M33 x 1.5  
Materials: Steel  
Pressures: Up to 4000 psi

**60° Cone BSPP K4**

Sizes: 1/8" – 2"  
Materials: Steel  
Pressures: Up to 5000 psi

## How to Order Parker Hose Adapters

When ordering Parker Adapters, please state the Catalogued Number of each type of adapter desired. Be sure to double check tube and hose sizes of items required.

To select proper seal materials for specific applications, refer to Media Compatibility Chart in Tube Fitting Catalog 4300, or contact your Parker Tube Fitting Distributor.

If in doubt about which type or size of fitting to specify, consult your Parker Tube Fitting Distributor. In addition Parker Field Sales, Technical Services, the Tube Fitting Division and your local Parker Service Center will help you find answers to all your issues.

**Phone:** (614) 279-7070

**Fax:** (614) 279-7685

**Web:** <http://www.parker.com/tfd>



# 15T3

## SAE (Code 61) Flange – Male SAE (JIC) 37° Flare

Part Number	Flange		Thread T1	Maximum Working Pressure psi	A		W	F
	inch	inch			inch	mm		
15T3-8-8	1/2	1/2	3/4x16	4000	2.80	71	1-1/4	1-3/16
15T3-12-12	3/4	3/4	1-1/16x12	3100	3.20	81	1-9/16	1-1/2
15T3-16-12	1	3/4	1-1/16x12	3100	2.68	47	1-1/8	1-3/4
15T3-16-16	1	1	1-5/16x12	2400	3.22	82	1-7/8	1-3/4
15T3-20-16	1-1/4	1	1-5/16x12	2400	2.76	51	1-3/8	2
15T3-20-20	1-1/4	1-1/4	1-5/8x12	1800	3.69	94	2-1/4	2
15T3-24-24	1-1/2	1-1/2	1-7/8x12	1300	4.04	103	2-1/2	2-3/8
15T3-32-32	2	2	2-1/2x12	1150	4.44	113	2-7/8	2-13/16

**WARNING:** This product can expose you to chemicals including Lead, which is known to the State of California to cause cancer and birth defects or other reproductive harm. For more information go to [www.p65warnings.ca.gov](http://www.p65warnings.ca.gov).

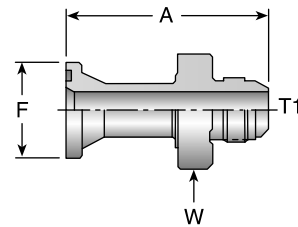

[view on web page](#)

# 17T3

## SAE (Code 61) Flange – Male SAE (JIC) 37° Flare - 45° Elbow

Part Number	Flange		Thread T1	Maximum Working Pressure psi	A		E		W	F
	inch	inch			inch	mm	inch	mm		
17T3-8-8	1/2	1/2	3/4x16	4000	2.54	65	0.78	20	13/16	1-3/16
17T3-12-12	3/4	3/4	1-1/16x12	3100	2.76	70	1.00	25	1-9/16	1-1/2
17T3-16-12	1	3/4	1-1/16x12	3100	2.72	70	1.00	25	1-1/8	1-3/4
17T3-16-16	1	1	1-5/16x12	2400	2.99	76	1.06	27	1-3/8	1-3/4
17T3-20-16	1-1/4	1	1-5/16x12	2400	2.99	76	1.06	27	1-7/8	2
17T3-20-20	1-1/4	1-1/4	1-5/8x12	1800	3.22	82	1.12	28	1-11/16	2-3/8
17T3-24-20	1-1/2	1-1/4	1-5/8x12	1800	3.26	83	1.17	30	1-11/16	2-3/8
17T3-24-24	1-1/2	1-1/2	1-7/8x12	1300	3.43	87	1.12	28	2	2-3/8
17T3-32-32	2	2	2-1/2x12	1150	4.02	102	1.25	32	2-5/8	2-13/16

**WARNING:** This product can expose you to chemicals including Lead, which is known to the State of California to cause cancer and birth defects or other reproductive harm. For more information go to [www.p65warnings.ca.gov](http://www.p65warnings.ca.gov).

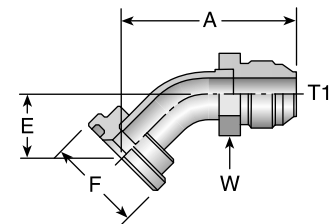

[view on web page](#)

# 19T3

## SAE (Code 61) Flange – Male SAE (JIC) 37° Flare - 90° Elbow

Part Number	Flange		Thread T1	Maximum Working Pressure psi	A		E		W	F
	inch	inch			inch	mm	inch	mm		
19T3-8-8	1/2	1/2	3/4x16	4000	1.92	49	1.62	41	13/16	1-13/16
19T3-12-12	3/4	3/4	1-1/16x12	3100	2.46	62	2.12	54	1-1/8	1-1/2
19T3-16-12	1	3/4	1-1/16x12	3100	2.46	62	2.12	54	1-3/8	1-3/4
19T3-20-12	1-1/4	3/4	1-1/16x12	3100	2.46	62	2.12	54	1-3/8	2
19T3-16-16	1	1	1-5/16x12	2400	2.79	71	2.37	60	1-3/8	1-3/4
19T3-20-16	1-1/4	1	1-5/16x12	2400	2.79	71	2.37	60	1-3/8	2
19T3-24-16	1-1/2	1	1-5/16x12	2400	2.79	71	2.44	62	1-11/16	2-3/8
19T3-20-20	1-1/4	1-1/4	1-5/8x12	1800	3.12	79	2.50	64	1-11/16	2
19T3-24-20	1-1/2	1-1/4	1-5/8x12	1800	3.12	79	2.56	65	1-11/16	2-3/8
19T3-20-24	1-1/4	1-1/2	1-7/8x12	1300	3.48	88	2.69	68	2	2
19T3-24-24	1-1/2	1-1/2	1-7/8x12	1300	3.48	88	2.75	70	2	2-3/8
19T3-32-24	2	1-1/2	1-7/8x12	1300	3.48	88	2.75	70	2	2-13/16
19T3-32-32	2	2	2-1/2x12	1150	5.61	142	4.50	114	2-5/8	2-13/16

**WARNING:** This product can expose you to chemicals including Lead, which is known to the State of California to cause cancer and birth defects or other reproductive harm. For more information go to [www.p65warnings.ca.gov](http://www.p65warnings.ca.gov).

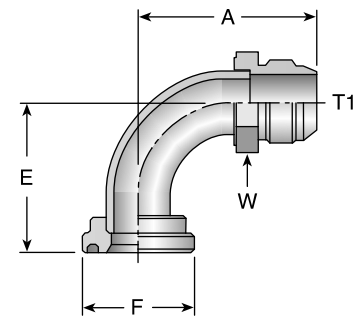

[view on web page](#)

### 39T3

#### Male - Female Swivel - SAE (JIC) 37° - 90° Elbow

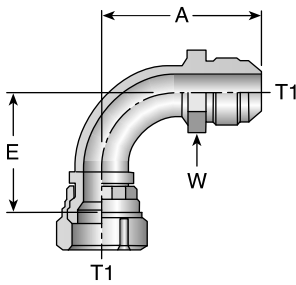

view on web page

Part Number	Thread T1		Maximum Working Pressure psi	A		E		W
	inch	mm		inch	mm	inch		
39T3-6-6	3/8	9/16x18	4500	1.61	41	0.85	22	5/8
39T3-8-8	1/2	3/4x16	4000	1.86	47	1.09	28	13/16
39T3-10-10	5/8	7/8x14	3600	2.13	54	1.24	31	15/16
39T3-12-12	3/4	1-1/16x12	3100	2.62	67	1.81	46	1-1/8
39T3-16-16	1	1-5/16x12	2400	2.94	75	2.14	54	1-3/8
39T3-20-20	1-1/4	1-5/8x12	1800	3.12	79	2.59	66	1-11/16

**WARNING:** This product can expose you to chemicals including Lead, which is known to the State of California to cause cancer and birth defects or other reproductive harm. For more information go to [www.p65warnings.ca.gov](http://www.p65warnings.ca.gov).

### 41T3

#### Male - Female Swivel - SAE (JIC) 37° - 90° Elbow - Long

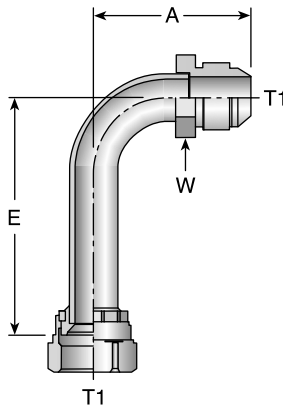

view on web page

Part Number	Thread T1		Maximum Working Pressure psi	A		E		W
	inch	mm		inch	mm	inch		
41T3-8-8	1/2	3/4x16	4000	1.94	49	2.43	62	13/16
41T3-10-10	5/8	7/8x14	3600	2.20	56	2.57	65	15/16
41T3-12-12	3/4	1-1/16x12	3100	2.50	64	3.74	95	1-1/8
41T3-16-16	1	1-5/16x12	2400	2.79	71	4.23	107	1-3/8

**WARNING:** This product can expose you to chemicals including Lead, which is known to the State of California to cause cancer and birth defects or other reproductive harm. For more information go to [www.p65warnings.ca.gov](http://www.p65warnings.ca.gov).

### 4AH3

#### SAE Code 61 Flange - Male SAE (JIC) 37° Flare

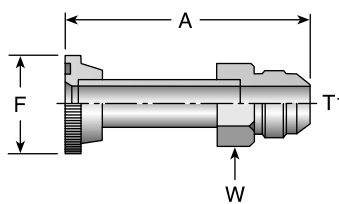

view on web page

Part Number	Flange	Thread T1		Maximum Working Pressure psi	A		W	F
	inch	inch	mm		inch	mm	inch	inch
4AH3-12-12	3/4	3/4	1-1/16x12	5000	3.82	97	1-1/8	1-1/2
4AH3-16-16	1	1	1-5/16x12	4500	4.09	104	1-3/8	1-3/4
4AH3-20-20	1-1/4	1-1/4	1-5/8x12	4400	4.16	106	1-3/4	2
4AH3-24-24	1-1/2	1-1/2	1-7/8x12	4250	4.97	126	2	2-3/8

**WARNING:** This product can expose you to chemicals including Lead, which is known to the State of California to cause cancer and birth defects or other reproductive harm. For more information go to [www.p65warnings.ca.gov](http://www.p65warnings.ca.gov).

### 4FH3

#### SAE Code 61 Flange - Male SAE (JIC) 37° Flare - 45° Elbow

Part Number	Flange		Thread T1	Maximum Working Pressure psi	A		E		W inch	F inch
	inch	inch			inch	mm	inch	mm		
4FH3-12-12	3/4	3/4	1-16x12	5000	3.39	86	1.06	27	1-1/8	1-1/2
4FH3-16-16	1	1	1-5/16x12	4500	3.85	98	1.27	32	1-3/8	1-3/4
4FH3-20-20	1-1/4	1-1/4	1-5/8x12	4400	4.22	107	1.36	35	1-3/4	2

**WARNING:** This product can expose you to chemicals including Lead, which is known to the State of California to cause cancer and birth defects or other reproductive harm. For more information go to [www.p65warnings.ca.gov](http://www.p65warnings.ca.gov).

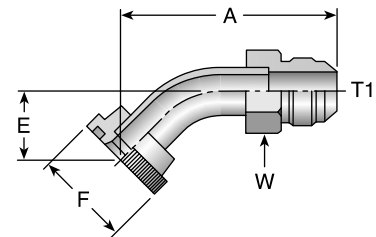

view on web page

### 4NH3

#### SAE Code 61 Flange - Male SAE (JIC) 37° Flare - 90° Elbow

Part Number	Flange		Thread T1	Maximum Working Pressure psi	A		E		W inch	F inch
	inch	inch			inch	mm	inch	mm		
4NH3-8-8	1/2	1/2	3/4x16	5000	1.93	49	1.68	43	13/16	1-13/16
4NH3-12-12	3/4	3/4	1-1/16x12	5000	3.07	78	2.24	57	1-1/8	1-1/2
4NH3-16-16	1	1	1-5/16x12	4500	3.25	83	2.48	63	1-3/8	1-3/4
4NH3-20-20	1-1/4	1-1/4	1-5/8x12	4400	4.68	119	2.99	76	1-3/4	2
4NH3-24-24	1-1/2	1-1/2	1-7/8x12	4250	3.92	100	3.64	92	2	2-3/8

**WARNING:** This product can expose you to chemicals including Lead, which is known to the State of California to cause cancer and birth defects or other reproductive harm. For more information go to [www.p65warnings.ca.gov](http://www.p65warnings.ca.gov).

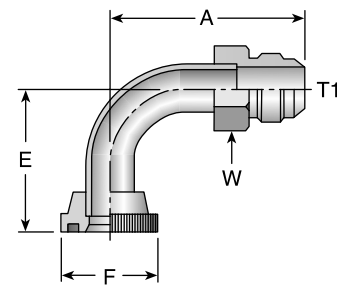

view on web page

### 6AH3

#### SAE Code 62 Flange - Male SAE (JIC) 37° Flare

Part Number	Flange		Thread T1	Maximum Working Pressure psi	A		W inch	F inch
	inch	inch			inch	mm		
6AH3-12-12	3/4	3/4	1-1/16x12	5000	3.82	97	1-1/8	1-5/8
6AH3-16-16	1	1	1-5/16x12	4500	4.09	104	1-3/8	1-7/8
6AH3-20-20	1-1/4	1-1/4	1-5/8x12	4400	4.16	106	1-3/4	2-1/8
6AH3-24-24	1-1/2	1-1/2	1-7/8x12	4250	4.97	126	2	2-1/2

**WARNING:** This product can expose you to chemicals including Lead, which is known to the State of California to cause cancer and birth defects or other reproductive harm. For more information go to [www.p65warnings.ca.gov](http://www.p65warnings.ca.gov).

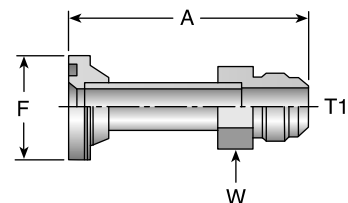

view on web page

### 6FH3

#### SAE Code 62 Flange - Male SAE (JIC) 37° Flare - 45° Elbow

Part Number	Flange		Thread T1	Maximum Working Pressure psi	A		E		W inch	F inch
	inch	inch			inch	mm	inch	mm		
6FH3-12-12	3/4	3/4	1-1/16x12	5000	3.40	86	1.06	27	1-1/8	1-5/8
6FH3-16-16	1	1	1-5/16x12	4500	3.85	98	1.28	33	1-3/8	1-7/8
6FH3-20-20	1-1/4	1-1/4	1-5/8x12	4400	4.22	107	1.36	35	1-3/4	2-1/8
6FH3-24-24	1-1/2	1-1/2	1-7/8x12	4250	5.13	130	1.71	43	2	2-1/2

**WARNING:** This product can expose you to chemicals including Lead, which is known to the State of California to cause cancer and birth defects or other reproductive harm. For more information go to [www.p65warnings.ca.gov](http://www.p65warnings.ca.gov).

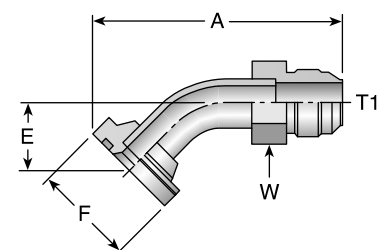

view on web page

### 6NH3

#### SAE Code 62 Flange - Male SAE (JIC) 37° Flare - 90° Elbow

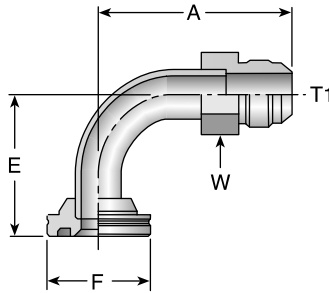

view on web page

Part Number	Flange inch	Thread T1	Maximum Working Pressure psi	A		E		W inch	F inch
				inch	mm	inch	mm		
6NH3-12-12	3/4	3/4 1-1/16x12	5000	3.07	78	2.24	57	1-1/8	1-5/8
6NH3-16-16	1	1 1-5/16x12	5000	3.58	91	2.81	71	1-3/8	1-7/8
6NH3-20-20	1-1/4	1-1/4 1-5/8x12	4400	4.68	119	2.99	76	1-3/4	2-1/8
6NH3-24-24	1-1/2	1-1/2 1-7/8x12	4250	3.92	100	3.64	92	2	2-1/2

**WARNING:** This product can expose you to chemicals including Lead, which is known to the State of California to cause cancer and birth defects or other reproductive harm. For more information go to [www.p65warnings.ca.gov](http://www.p65warnings.ca.gov).

### 4AJM

#### Code 61 Flange - Male Seal-Lok

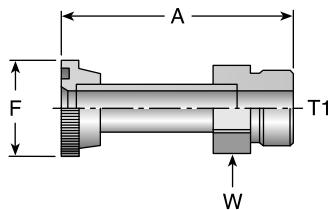

view on web page

Part Number	Flange inch	Thread T1	Maximum Working Pressure psi	A		W inch	F inch
				inch	mm		
4AJM-12-12	3/4	1-3/16x12	5000	3.65	93	1-1/4	1-1/2
4AJM-16-16	1	1-7/16x12	4500	3.90	99	1-1/2	1-3/4

JM adapters do not include O-rings. Order separately.

**WARNING:** This product can expose you to chemicals including Lead, which is known to the State of California to cause cancer and birth defects or other reproductive harm. For more information go to [www.p65warnings.ca.gov](http://www.p65warnings.ca.gov).

### 4FJM

#### Code 61 Flange - Male Seal-Lok - 45° Elbow

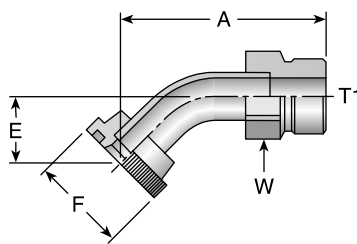

view on web page

Part Number	Flange inch	Thread T1	Maximum Working Pressure psi	A		E		W inch	F inch
				inch	mm	inch	mm		
4FJM-16-16	1	1-7/16x12	4500	3.64	92	1.27	33	1-1/2	1-3/4

JM adapters do not include O-rings. Order separately.

**WARNING:** This product can expose you to chemicals including Lead, which is known to the State of California to cause cancer and birth defects or other reproductive harm. For more information go to [www.p65warnings.ca.gov](http://www.p65warnings.ca.gov).

### 4NJM

#### Code 61 Flange - Male Seal-Lok - 90° Elbow

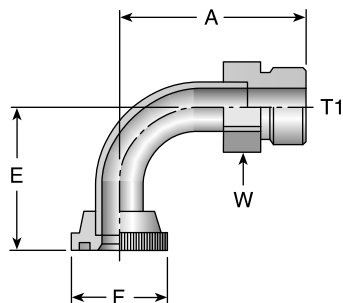

view on web page

Part Number	Flange inch	Thread T1	Maximum Working Pressure psi	A		E		W inch	F inch
				inch	mm	inch	mm		
4NJM-12-12	3/4	1-3/16x12	5000	2.90	74	2.24	57	1-1/4	1-1/2
4NJM-16-16	1	1-7/16x12	4500	3.38	86	2.81	71	1-1/2	1-3/4
4NJM-20-20	1-1/4	1-11/16x12	4000	4.44	113	2.99	76	1-3/4	2

JM adapters do not include O-rings. Order separately.

**WARNING:** This product can expose you to chemicals including Lead, which is known to the State of California to cause cancer and birth defects or other reproductive harm. For more information go to [www.p65warnings.ca.gov](http://www.p65warnings.ca.gov).

## 6AJM

### Code 62 Flange - Male Seal-Lok

Part Number	Flange inch	Thread T1	Maximum Working Pressure psi	A		W inch	F inch
				inch	mm		
6AJM-12-12	3/4	1-3/16x12	5000	3.65	93	1-1/4	1-5/8
6AJM-16-16	1	1-7/16x12	4500	3.90	99	1-1/2	1-7/8

JM adapters do not include O-rings. Order separately.

**WARNING:** This product can expose you to chemicals including Lead, which is known to the State of California to cause cancer and birth defects or other reproductive harm. For more information go to [www.p65warnings.ca.gov](http://www.p65warnings.ca.gov).

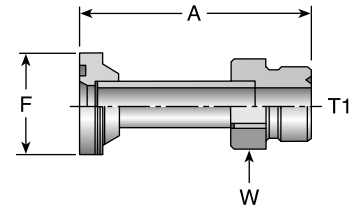

[view on web page](#)

## 6FJM

### Code 62 Flange - Male Seal-Lok - 45° Elbow

Part Number	Flange inch	Thread T1	Maximum Working Pressure psi	A		E		W inch	F inch
				inch	mm	inch	mm		
6FJM-12-12	3/4	1-3/16x12	5000	3.22	82	1.06	27	1-1/4	1-5/8
6FJM-16-16	1	1-7/16x12	4500	3.64	92	1.27	33	1-1/2	1-7/8

JM adapters do not include O-rings. Order separately.

**WARNING:** This product can expose you to chemicals including Lead, which is known to the State of California to cause cancer and birth defects or other reproductive harm. For more information go to [www.p65warnings.ca.gov](http://www.p65warnings.ca.gov).

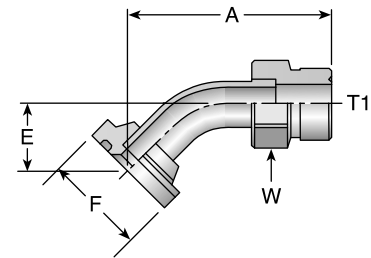

[view on web page](#)

## 6NJM

### Code 62 Flange - Male Seal-Lok - 90° Elbow

Part Number	Flange inch	Thread T1	Maximum Working Pressure psi	A		E		W inch	F inch
				in	mm	in	mm		
6NJM-12-12	3/4	1-3/16x12	5000	2.90	74	2.24	57	1-1/4	1-5/8
6NJM-16-16	1	1-7/16x12	5000	3.38	86	2.81	71	1-1/2	1-7/8
6NJM-20-20	1-1/4	1-11/16x12	4000	4.44	113	2.99	76	1-3/4	2-1/8

JM adapters do not include O-rings. Order separately.

**WARNING:** This product can expose you to chemicals including Lead, which is known to the State of California to cause cancer and birth defects or other reproductive harm. For more information go to [www.p65warnings.ca.gov](http://www.p65warnings.ca.gov).

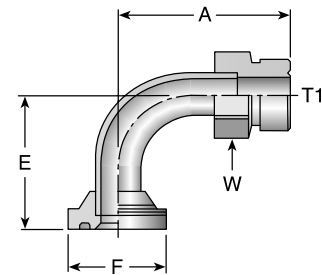

[view on web page](#)

## SAE J518 port dimensions for 4-Bolt Split Flanges

There are two non-interchangeable SAE split flanges:

- a. Standard or Code 61 is for 3,000psi to 5,000psi maximum, depending on size.
- b. High Pressure or Code 62 is for 6,000psi maximum, regardless of size. The flange head is "V" notched for identification.

Consult these tables to determine flange halves and flange kits specifications.

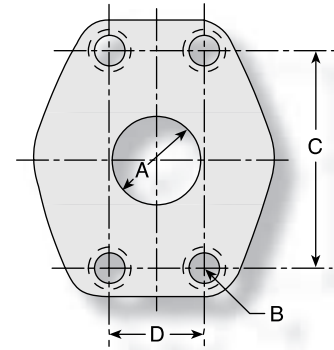

### Standard Pressure (Code 61) [view on web page](#)

Nominal Flange	Flange Dash Size	A Dia Max		B Thread	C		D		Maximum Working Pressure	
		inch	mm		±0.010 inch	±0,25 mm	±0.010 inch	±0,25 mm	psi	MPa
1/2	-8	0.50	13	5/16x18	1.50	38,10	0.68	17,47	5000	34,5
3/4	-12	0.75	19	3/8x16	1.88	47,63	0.87	22,22	5000	34,5
1	-16	1.00	25	3/8x16	2.06	52,37	1.03	26,18	5000	34,5
1 1/4	-20	1.25	32	7/16x14	2.31	58,72	1.18	30,17	4000*	27,6
1 1/2	-24	1.50	38	1/2x13	2.75	69,85	1.40	35,71	3000*	20,7
2	-32	2.00	51	1/2x13	3.06	77,77	1.68	42,87	3000*	20,7

Note: \*5000 psi with 4A, 4F and 4N Fittings and 50H Flange Halves.

**WARNING:** This product can expose you to chemicals including Lead, which is known to the State of California to cause cancer and birth defects or other reproductive harm. For more information go to [www.p65warnings.ca.gov](http://www.p65warnings.ca.gov).

### High Pressure (Code 62) [view on web page](#)

Nominal Flange	Flange Dash Size	A Dia Max		B Thread	C		D		Maximum Working Pressure	
		inch	mm		±0.010 inch	±0,25 mm	±0.010 inch	±0,25 mm	psi	MPa
3/4	-12	0.75	19	3/8x16	2.00	47,75	0.88	22,35	6000	41,4
1	-16	1.00	25	7/16x14	2.25	57,15	1.09	27,76	6000	41,4
1-1/4	-20	1.25	32	1/2x13	2.63	66,67	1.25	31,75	6000	41,4
1-1/2	-24	1.50	38	5/8x11	3.13	79,37	1.43	36,49	6000	41,4
2	-32	2.00	51	3/4x10	3.81	96,82	1.75	44,45	6000	41,4

**WARNING:** This product can expose you to chemicals including Lead, which is known to the State of California to cause cancer and birth defects or other reproductive harm. For more information go to [www.p65warnings.ca.gov](http://www.p65warnings.ca.gov).

### 50H 5000 psi Flange Half (Code 61)

Part Number	SAE Flange Size	A	B	C	Maximum Working Pressure
	inch	inch	inch	inch	psi
50H-20	1-1/4	2.31	0.55	0.47	5000
50H-24	1-1/2	2.75	0.66	0.53	5000
50H-32	2	3.06	0.80	0.53	5000

Note: For use with 4A, 4F and 4N Flanges.

**WARNING:** This product can expose you to chemicals including Lead, which is known to the State of California to cause cancer and birth defects or other reproductive harm. For more information go to [www.p65warnings.ca.gov](http://www.p65warnings.ca.gov).

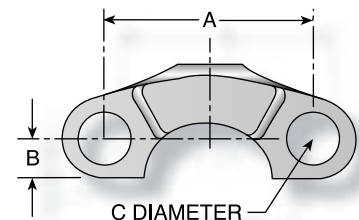

[view on web page](#)

## 5050HK 5000 psi Flange Kit (Code 61)

Part Number	SAE Flange Size inch	Maximum Working Pressure psi	(2) Flange Halves	O-Ring	(4) Bolts Grade 8		(4) Washers
					Thread inch	Length inch	
5050HK-20	1-1/4	5000	50H-20	711510-3	7/16x14	1-1/2	7/16
5050HK-24	1-1/2	5000	50H-24	711510-2	1/2x13	1-1/2	1/2
5050HK-32	2	5000	50H-32	711510-1	1/2x13	1-1/2	1/2

**Note:** For use with 4A, 4F and 4N Flanges.

**WARNING:** This product can expose you to chemicals including Lead, which is known to the State of California to cause cancer and birth defects or other reproductive harm. For more information go to [www.p65warnings.ca.gov](http://www.p65warnings.ca.gov).

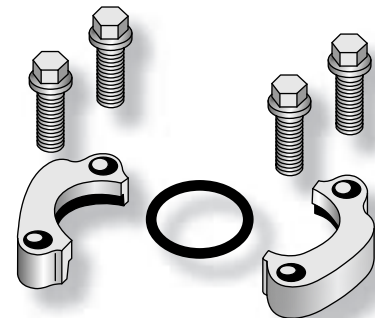

[view on web page](#)

## 51H SAE Flange Half (Code 61)

Part Number	SAE Flange Size inch	A inch	B inch	C inch	Maximum Working Pressure
					psi
51H-8	1/2	1.50	0.31	0.35	5000
51H-12	3/4	1.88	0.40	0.42	5000
51H-16	1	2.06	0.48	0.42	5000
51H-20	1-1/4	2.31	0.56	0.42	4000
51H-24	1-1/2	2.75	0.67	0.53	3000
51H-32	2	3.06	0.81	0.53	3000
51H-40	2-1/2	3.50	0.96	0.53	2500
51H-48	3	4.19	1.18	0.66	2000

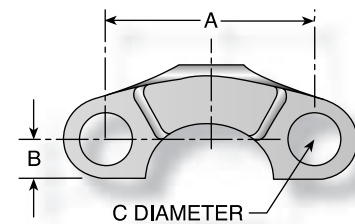

[view on web page](#)

**WARNING:** This product can expose you to chemicals including Lead, which is known to the State of California to cause cancer and birth defects or other reproductive harm. For more information go to [www.p65warnings.ca.gov](http://www.p65warnings.ca.gov).

## 5151HK SAE Flange Kit (Code 61)

Part Number	SAE Flange Size inch	Maximum Working Pressure psi	(2) Flange Halves	O-Ring	(4) Bolts Grade 8		(4) Washers
					Thread inch	Length inch	
5151HK-8	1/2	5000	51H-8	711510-6	5/16x18	1-1/4	5/16
5151HK-12	3/4	5000	51H-12	711510-5	3/8x16	1-1/4	3/8
5151HK-16	1	5000	51H-16	711510-4	3/8x16	1-1/4	3/8
5151HK-20	1-1/4	4000	51H-20	711510-3	7/16x14	1-1/2	7/16
5151HK-24	1-1/2	3000	51H-24	711510-2	1/2x13	1-1/2	1/2
5151HK-32	2	3000	51H-32	711510-1	1/2x13	1-1/2	1/2
5151HK-40	2-1/2	2500	51H-40	711510-7	1/2x13	1-3/4	1/2
5151HK-48	3	2000	51H-48	711510-8	5/8-11	1-3/4	5/8

**Note:** High pressure applications also require the use of Code 61 Flange End hose fittings.

**WARNING:** This product can expose you to chemicals including Lead, which is known to the State of California to cause cancer and birth defects or other reproductive harm. For more information go to [www.p65warnings.ca.gov](http://www.p65warnings.ca.gov).

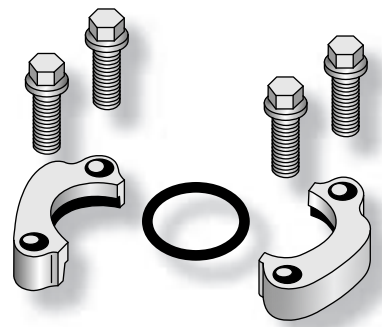

[view on web page](#)

## HFH SAE Flange Half (Code 62)

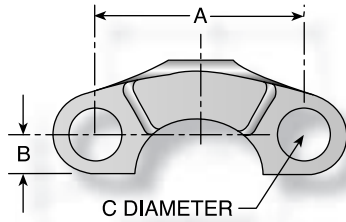

view on web page

Part Number	SAE Flange Size	A	B	C	Maximum Working Pressure
	inch	inch	inch	inch	psi
HFH-12	3/4	2.00	0.43	0.41	6000
HFH-16	1	2.25	0.51	0.47	6000
HFH-20	1 1/4	2.62	0.59	0.53	6000
HFH-24	1 1/2	3.12	0.68	0.66	6000
HFH-32	2	3.81	0.84	0.78	6000

**WARNING:** This product can expose you to chemicals including Lead, which is known to the State of California to cause cancer and birth defects or other reproductive harm. For more information go to [www.p65warnings.ca.gov](http://www.p65warnings.ca.gov).

## HFHFHK SAE Flange Kit (Code 62)

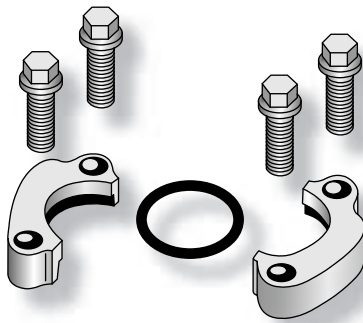

view on web page

Part Number	SAE Flange Size	Maximum Working Pressure	(2) Flange Halves	O-Ring	(4) Bolts Grade 8		(4) Washers
					Thread	Length	
	inch	psi			inch	inch	
HFHFHK-12	3/4	6000	HFH-12	711510-5	3/8x16	1-1/2	3/8
HFHFHK-16	1	6000	HFH-16	711510-4	7/16x14	1-3/4	7/16
HFHFHK-20	1-1/4	6000	HFH-20	711510-3	1/2x13	1-3/4	1/2
HFHFHK-24	1-1/2	6000	HFH-24	711510-2	5/8x11	2-1/4	5/8
HFHFHK-32	2	6000	HFH-32	711510-1	3/4x10	2-3/4	3/4

**WARNING:** This product can expose you to chemicals including Lead, which is known to the State of California to cause cancer and birth defects or other reproductive harm. For more information go to [www.p65warnings.ca.gov](http://www.p65warnings.ca.gov).



# Full Flange System

## SAE J518 Code 61 or Code 62

Parker's Hose Products Division introduces a one-piece flange option for Code 61 and Code 62 connections. The patent-pending design enables the flange to be attached to the hose after the hose fitting has been crimped to the hose. Once the fitting is crimped, an SAE J518 Code 61 or a Code 62 full flange can be attached using the high tensile stainless steel retaining ring. The versatile fitting design enables greater flexibility by reducing the number of potential hose fittings in your inventory.

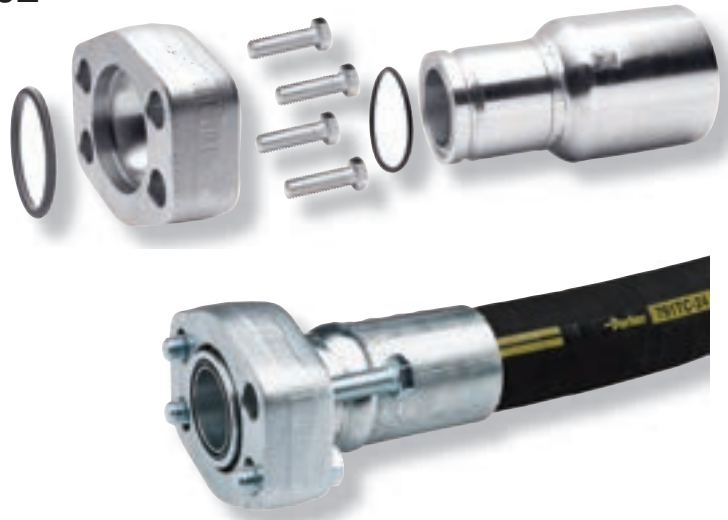

**Product Features**

- One-piece full flange connection
- The full flange system is designed to work with all Parkrimp crimpers
- Fittings are compatible for both Code 61 and Code 62 flanges
- All Code 61 sizes rated to 5000 psi

[view on web page](#)

### Flange Kits:

#### Code 61 Flange Kit - All sizes rated for 5000 psi

Part Number	SAE Flange Size inch	Maximum Working Pressure psi	Flange	Seal	Retaining Ring	(4) Bolts Grade 8	
						Thread inch	Length inch
FFK61-12	3/4	5000	R312-35-CFX	XRG-12	R12X	UNC 3/8 - 16	1-1/2
FFK61-16	1	5000	R316-CFX	XRG-16	R16X	UNC 3/8 - 16	1-1/2
FFK61-20	1 1/4	5000	R320-12.5-CFX	XRG-20	R20X	UNC 7/16 - 14	1-1/2
FFK61-24	1 1/2	5000	R324-CFX	XRG-24	R24X	UNC 1/2 - 13	1-3/4

**⚠ WARNING:** This product can expose you to chemicals including Lead, which is known to the State of California to cause cancer and birth defects or other reproductive harm. For more information go to [www.p65warnings.ca.gov](http://www.p65warnings.ca.gov).

#### Code 62 Flange Kit

Part Number	SAE Flange Size inch	Maximum Working Pressure psi	Flange	Seal	Retaining Ring	(4) Bolts Grade 8	
						Thread inch	Length inch
FFK62-12	3/4	6000	R612-35-CFX	XRG-12	R12X	UNC 3/8 - 16	1-1/2
FFK62-16	1	6000	R616-CFX	XRG-16	R16X	UNC 7/16 - 14	1-1/2
FFK62-20	1 1/4	6000	R620-CFX	XRG-20	R20X	UNC 1/2 - 13	1-3/4
FFK62-24	1 1/2	6000	R624-CFX	XRG-24	R24X	UNC 5/8 - 11	2-1/4
FFK62-32	2	6000	R632-CFX	XRG-32	R32X	UNC 3/4 - 10	2-3/4

**⚠ WARNING:** This product can expose you to chemicals including Lead, which is known to the State of California to cause cancer and birth defects or other reproductive harm. For more information go to [www.p65warnings.ca.gov](http://www.p65warnings.ca.gov).

Kit Part Number	Retaining Ring	O-ring
RK-12	R12X	XRG-12
RK-16	R16X	XRG-16
RK-20	R20X	XRG-20
RK-24	R24X	XRG-24
RK-32	R32X	XRG-32

The stainless steel retaining rings and O-rings are recommended for one-time use. Order additional ring kits using the part numbers shown.

## DIN and ISO Metric Ports

DIN (German) and ISO (International Organization for Standardization) flange heads are the same as SAE flange heads. By comparison, the ports have the same configuration except that the DIN and ISO Type I ports accept metric bolts. This requires special flange halves in most sizes.

SAE J518	DIN 20078	ISO 6162 Type I
Code 61	Form R	3,5 to 35 MPa Series
Code 62	Form S	35 to 40 MPa Series

### M1H DIN (ISO) Flange Half

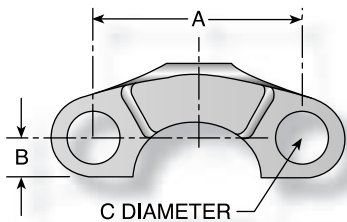

view on web page

Part Number	DIN Flange Size	ISO Flange Size	A mm	B mm	C mm	Maximum Working Pressure	
						psi	MPa
51H-12	12	19	48	10	11	5000	34,5
51H-16	16	25	52	12	11	5000	34,5
51H-20	20	32	59	14	11	4000	27,6
51H-24	24	38	70	17	13.5	3000	20,7

Note: High pressure applications also require the use of Code 62 Flange End hose fittings.

**⚠ WARNING:** This product can expose you to chemicals including Lead, which is known to the State of California to cause cancer and birth defects or other reproductive harm. For more information go to [www.p65warnings.ca.gov](http://www.p65warnings.ca.gov).

### M1M1HK DIN (ISO) Flange Kit (Code 61)

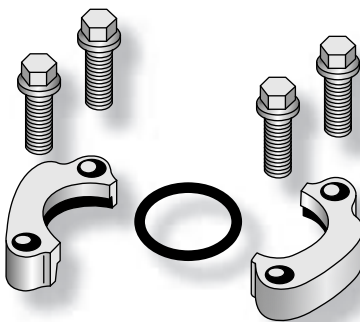

view on web page

Part Number	DIN Flange Size	ISO Flange Size	Maximum Working Pressure		(2) Flange Ha	O-Ring	(4) Bolts		(4) Washers
			psi	MPa			Thread mm	Length mm	
M1M1HK-8	8	13	5000	34,5	51H-8	711510-6	M8x1.25	30	10
M1M1HK-12	12	19	5000	34,5	51H-12	711510-5	M10x1.50	30	10
M1M1HK-16	16	25	5000	34,5	51H-16	711510-4	M10x1.50	30	10
M1M1HK-20	20	32	4000	27,6	51H-20	711510-3	M10x1.50	40	10
M1M1HK-24	24	38	3000	20,7	M1H-24	711510-2	M12x1.75	40	12
M1M1HK-32	32	51	3000	20,7	M1H-32	711510-1	M12x1.75	40	12

**⚠ WARNING:** This product can expose you to chemicals including Lead, which is known to the State of California to cause cancer and birth defects or other reproductive harm. For more information go to [www.p65warnings.ca.gov](http://www.p65warnings.ca.gov).

## M2H

### DIN (ISO) Flange Half (Code 62)

Part Number	DIN Flange Size	ISO Flange Size	A	B	C	Maximum Working Pressure	
						psi	MPa
HFH-12	12	19	51	11	10,6	6000	41,5
M2H-16	16	25	57	13	13,5	6000	41,5
M2H-20	20	32	67	15	15,0	6000	41,5
HFH-24	24	38	79	17	16,7	6000	41,5
HFH-32	32	51	97	21	20,6	6000	41,5

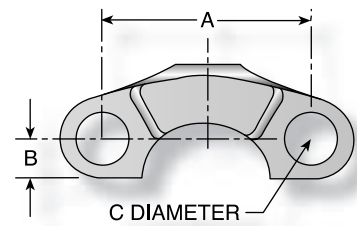

[view on web page](#)

**WARNING:** This product can expose you to chemicals including Lead, which is known to the State of California to cause cancer and birth defects or other reproductive harm. For more information go to [www.p65warnings.ca.gov](http://www.p65warnings.ca.gov).

## M2M2HK

### DIN (ISO) Flange Kit (Code 62)

Part Number	DIN Flange Size	ISO Flange Size	Maximum Working Pressure		(2) Flange Halves	O-Ring	(4) HHCS		(4) Washers
			psi	MPa			Thread	Length	
M2M2HK-8	8	13	6000	41,5	M2H-8	711510-6	M8x1.25	30	8
M2M2HK-12	12	19	6000	41,5	HFH-12	711510-5	M10x1.50	35	10
M2M2HK-16	16	25	6000	41,5	M2H-16	711510-4	M12x1.75	45	12
M2M2HK-20	20	32	6000	41,5	M2H-20	711510-3	M12x1.75	45	12
M2M2HK-24	24	38	6000	41,5	HFH-24	711510-2	M16x2.00	55	16
M2M2HK-32	32	51	6000	41,5	HFH-32	711510-1	M20x2.50	70	20

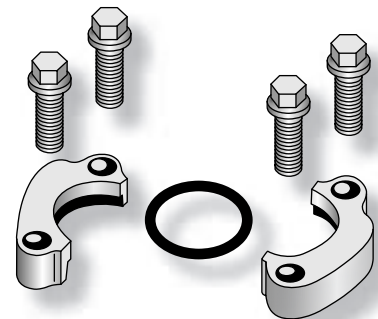

[view on web page](#)

**WARNING:** This product can expose you to chemicals including Lead, which is known to the State of California to cause cancer and birth defects or other reproductive harm. For more information go to [www.p65warnings.ca.gov](http://www.p65warnings.ca.gov).

## XCXCHK

### Caterpillar® Flange Kits

Part Number	C Diameter	Maximum Working Pressure	O-Ring	(4) Bolts Grade 8		(4) Washers
				Thread	Length	
XCXCHK-12	0.406	6000	XARG-12	3/8-16	1.75	3/8
XCXCHK-16	0.469	6000	XARG-16	7/16-14	1.75	7/16
XCXCHK-20	0.531	6000	XARG-20	1/2-13	2.00	1/2
XCXCHK-24	0.656	6000	XARG-24	5/8-11	2.50	5/8
XCXCHK-32	0.827	6000	XARG-32	3/4-10	2.75	3/4

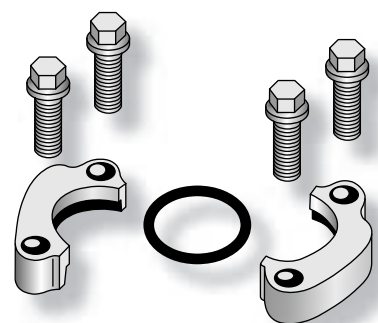

[view on web page](#)

**WARNING:** This product can expose you to chemicals including Lead, which is known to the State of California to cause cancer and birth defects or other reproductive harm. For more information go to [www.p65warnings.ca.gov](http://www.p65warnings.ca.gov).

# Engineered Flange Seal

## Engineered to seal. Designed to fit.

The Engineered Flange Seal (EFS) is designed to fit precisely into the seal groove of a Parker Code 61 or Code 62 Flange. Unlike standard O-rings that tend to pop out of the flange groove, the engineered shape of EFS fits precisely, providing consistently strong seal retention. O-rings pinching or falling out during assembly will no longer be an issue. O-rings with unsecured retention can cause dangerous, and time consuming hose assembly leaks. EFS reduces the possibility of the O-ring falling out, rework, replacement, and provides for quick assembly.

Your high pressure applications will benefit from its secure, engineered design. After installing Parker's EFS, you can expect reduced downtime and increased confidence from your guaranteed leak-free assembly.

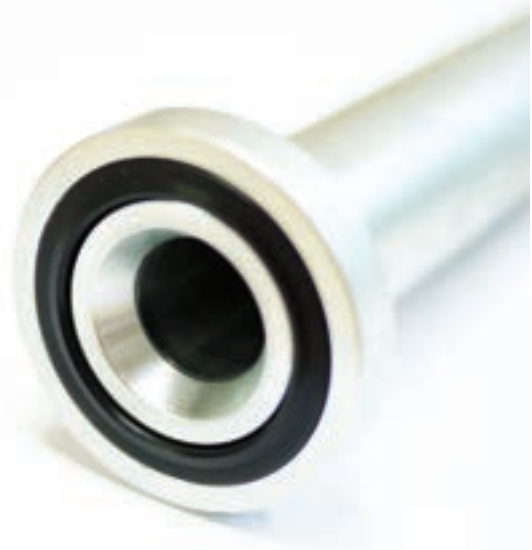

[view on web page](#)

### Product Features:

- Secure seal retention before, during and after installation
- Engineered for high pressure applications
- Quick assembly with no tooling or lubrication needed
- Reduced risk of seal damage and leakage
- Ability to withstand working temperatures up to 247°F
- 90 durometer nitrile

Part Number	Nominal Size	Dash Size
EFS-8	1/2	-8
EFS-12	3/4	-12
EFS-16	1	-16
EFS-20	1-1/4	-20
EFS-24	1-1/2	-24
EFS-32	2	-32

### Standard O-Ring

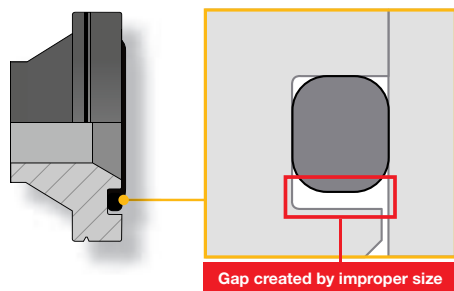

Standard O-rings have an unnatural fit in Code 61 and Code 62 flanges because of their improper size and shape. This off-the-shelf solution creates a gap which can lead to difficult installation, hose assembly leakage and the potential for the O-ring to fall out.

### Engineered Flange Seal

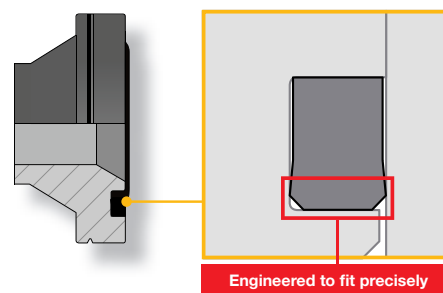

The EFS fits precisely in Code 61 and Code 62 flanges because its shape and size are engineered for the space and application. Its purpose-designed shape reduces the possibility of pop out, and the need to replace or reinstall the O-ring, eliminating costly leakage and time consuming pre-assembly handling.

## 711509

### O-Rings - SAE Thread (Compound N552-90)\*

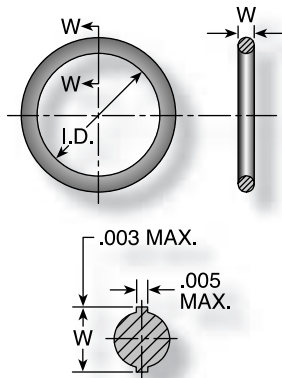

Part Number	Tube Dash Size	Tube O.D. inch	SAE Thread inch	W		I.D.	
				inch	mm	inch	mm
711509-1	-4	1/4	7/16x20	0.072	1,83	0.351	8,92
711509-2	-5	5/16	1/2x20	0.072	1,83	0.414	10,52
711509-3	-6	3/8	9/16x20	0.078	1,98	0.468	11,89
711509-4	-8	1/2	3/4x16	0.087	2,21	0.644	16,36
711509-5	-10	5/8	7/8x14	0.097	2,46	0.755	19,18
711509-6	-12	3/4	1-1/16x12	0.116	2,95	0.924	23,61
711509-7	-16	1	1-5/16x12	0.116	2,95	1.171	29,74
711509-8	-20	1-1/4	1-5/8x12	0.118	3,00	1.475	37,47
711509-9	-24	1-1/2	1-7/8x12	0.118	3,00	1.720	43,69
711509-10	-32	2	2-1/2x12	0.118	3,00	2.337	59,36

## 711510

### O-Rings - Code 61 and Code 62 Flanges (Compound N552-90)\*

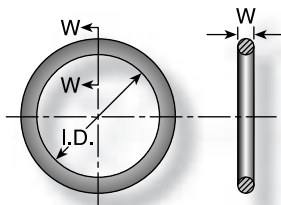

Part Number	Flange Dash Size	Flange Size inch	W		I.D.	
			inch	mm	inch	mm
711510-6	-8	1/2	0.14	3,53	0.73	18,64
711510-9*	-10	5/8	0.14	3,53	0.79	20,20
711510-5	-12	3/4	0.14	3,53	0.98	25,00
711510-4	-16	1	0.14	3,53	1.29	32,92
711510-3	-20	1-1/4	0.14	3,53	1.48	37,69
711510-2	-24	1-1/2	0.14	3,53	1.85	47,22
711510-1	-32	2	0.14	3,53	2.23	56,74
711510-7	-40	2-1/2	0.14	3,53	2.73	69,44
711510-8	-48	3	0.14	3,53	3.35	85,32

\*Note: For use with petroleum base fluids, other compounds available for Phosphate Ester fluids. Please contact The Parker Hannifin Seal Group/O-Ring Division (1-800-C-PARKER) for additional information.

## D9DT

### Bonded Seal for BSPF Port Fittings

Part Number	I.D.		O.D.	
	Inch	mm	Inch	mm
D9DT-4	0.54	13,7	0.81	20,6
D9DT-6	0.68	17,3	0.94	23,9
D9DT-8	0.85	21,6	1.13	28,7
D9DT-10	0.93	23,6	1.25	31,8
D9DT-12	1.06	27,0	1.38	35,1
D9DT-16	1.33	33,8	1.68	42,7

\*Note: D9DT must be ordered from the Tube Fittings Division. Please contact TFD for additional size and product information.

## JORG O-Rings - Seal-Lok®

Part Number	Tube Dash Size	Tube O.D. Inch	SAE Thread Inch	I.D.		O.D.	
				Inch	mm	Inch	mm
JORG-4	-4	1/4	9/16x18	0.301	7,65	0.070	1,78
JORG-6	-6	3/8	11/16x16	0.364	9,25	0.070	1,78
JORG-8	-8	1/2	13/16x16	0.489	12,42	0.070	1,78
JORG-10	-10	5/8	1x14	0.614	15,59	0.070	1,78
JORG-12	-12	3/4	1-3/16x12	0.739	18,77	0.070	1,78
JORG-16	-16	1	1-7/16x12	0.926	23,52	0.070	1,78
JORG-20	-20	1-1/4	1-11/16x12	1.176	29,87	0.070	1,78
JORG-24	-24	1-1/2	2x12	1.489	37,82	0.070	1,78

**Note:** O-Rings for use in Seal-Lok® connections are illustrated in actual size. Part numbers for O-Rings used in Seal-Lok® and in SAE port connections are also listed in the table. O-Rings are supplied in Nitrile NBR compound, 90 durometer hardness.

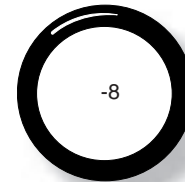

SAE 711509-4



Seal-Lok JORG-8

Photo shows an actual comparison between an SAE port O-Ring (top) and a Seal-Lok® O-Ring (bottom). They differ in both diameter and cross section.

## XARG Flange "D" Rings Caterpillar® Style Flanges

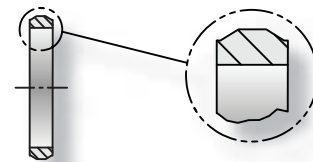

Part Number	Flange Size	Dash Size	Seal Thickness		I.D.		Fitting Series & Pressure Rating		Replaces P/N
			Inch	mm	Inch	mm	78 - 79 psi	76 psi	
XARG-12	3/4	-12	0.20	5,0	1.00	25,4	6,000	8,000	8ARG-12
XARG-16	1	-16	0.20	5,0	1.25	31,8	6,000	8,000	8ARG-16
XARG-20	1-1/4	-20	0.20	5,0	1.50	38,1	6,000	8,000	8ARG-20
XARG-24	1-1/2	-24	0.20	5,0	1.75	44,5	6,000	-	-
XARG-32	2	-32	0.20	5,0	2.52	63,9	6,000	-	-

## 59RG

### O-Rings for Tube O-Ring Fittings and Compressor Fittings

Part Number	Tube O.D. Inch	Tube Dash Size	Parker Seal Number
59RG-6	3/8	-6	2-011
59RG-8	1/2	-8	2-013
59RG-10	5/8	-10	2-015
59RG-12	3/4	-12	2-017

## T1RG

### O-Rings for Compression Fittings (1T126)

Part Number	Tube O.D. Inch	Tube Dash Size	Parker Seal Number
T1RG-6	3/8	-6	2-012
T1RG-8	1/2	-8	2-014
T1RG-10	5/8	-10	2-016
T1RG-12	3/4	-12	2-018

### R12

Part Number	Thread
940249	7/16x20

## CORG

### Captive O-Ring Assembly Tools

Parker's new CORG Assembly Tools are designed to facilitate the installation of the O-Ring into the half-dovetail groove of the O-Ring face seal fitting.

Fitting Size	Hand Type Part Number	Bench Type Part Number
-4	CORG-4	CORG-AT04 Bench
-6	CORG-6	CORG-AT06 Bench
-8	CORG-8	CORG-AT08 Bench
-10	CORG-10	CORG-AT10 Bench
-12	CORG-12	CORG-AT12 Bench
-16	CORG-16	CORG-AT16 Bench
-20	CORG-20	CORG-AT20 Bench
-24	CORG-24	CORG-AT24 Bench
-32	CORG-32	



Bench Type

Hand Type

**Note:** CORG Assembly Tools must be ordered from the Tube Fittings Division (614) 279-7070.

**Note:** O-Rings listed are for use with petroleum base fluids. Other compounds are available for Phosphate Ester fluids by special order. For Viton® or other O-Ring compounds, consult Parker Hannifin, Seal/O-Rings Products Division (1-800-C-PARKER.)

A

B

C

D

E

# Partek Defense

## Reliable, long-lasting protection

Partek Defense is designed to provide protection to personnel and equipment in the event of a hose burst by containing the energy of the burst.

Partek Defense features a multi-layered construction that contains and then dissipates the energy and media within the hose assembly.

Partek Defense can be applied in any hose application but is most valuable in industries such as mining, construction and agriculture where operators are in close proximity to high-pressure hoses.



[view on web page](#)

### Product Features

- Contains hose bursts up to 12,000 psi
- MSHA rated
- Meets ISO 3457, ISO 4413, EN 414, MDG41
- Multi-layer construction
- Sizes -4 to -16
- Made of high-performance materials and a proprietary weave pattern for reliable, long-lasting protection
- Easy to assemble
- Packaged in 50-ft. reels
- Temperature range: -70°F to +302°F

### Installation Instructions

- For use with one hose per sleeve
- Identify the size of the hose that needs to be protected
- Select the matching sleeve size from the chart
- Cut the sleeve length equal to the overall hose assembly length plus two inches
- Cut with a heat blade or heat scissors to avoid fraying
- Slide sleeve over the hose assembly (hose should be inserted into yellow layer)
- Must secure end of sleeve to hose fitting shell using a metal band clamp and the FSC Clamp Tool

### Partek Defense Hose Sleeve



Part Number	Hose Size ID*	Sleeve Flat ID "A"		Sleeve Round ID "B"	
		inch	mm	inch	mm
YS-B-17	-4	1.92	49	1.22	31
YS-B-19	-6	2.12	54	1.35	34
YS-B-22	-8	2.24	57	1.45	36
YS-B-27	-10	2.55	65	1.63	41
YS-B-33	-12	2.85	72	1.81	46
YS-B-37	-16	3.73	95	2.38	60

\*Approved with 43, 70, 71, 77 and 79 Series fittings.



# Partek Wrap

The need for a protective hose sleeve is not always considered while designing for a hose's application. Many hose assembly installations would benefit from a sleeve, but it is not obvious until all the other hoses and components are in place. Parker's Partek Wrap enables the hose sleeve to be installed after the hose assemblies have been positioned and secured in place. The Partek Wrap can be used as extra abrasion protection or to wrap multiple hoses or cables together.

### Product Features

- Post assembly installation
- Light weight and highly flexible
- Urethane-coated 1050 Ballistic Nylon
- Ambient temperature range of -60°F to +200°F
- Fast and easy installation
- MSHA Certified for use in underground mines
- Stays closed using hook & loop fastener



[view on web page](#)

# Partek Wrap

Part Number	Bundle O.D. inch	Circumference inch	Open Width (+/- 0.375) inch	Roll Length feet	Color
PS-BV-100	1	3.25	4.00	50	Black
PS-BV-200	2	6.00	7.75	50	Black
PS-BV-300	3	9.40	10.90	50	Black
PS-BV-400	4	12.50	14.00	50	Black
PS-BV-500	5	15.75	17.25	50	Black
PS-BV-700	7	22.00	23.50	50	Black



# Protective Coils, Sleeves & Guards

## Partek Sleeve

Parker's Partek Nylon Protective Sleeving gives you tough hose abrasion protection two ways. First, per the ISO 6945 specification, Partek has a unique tubular weave nylon construction. Partek "AS" is strong enough to withstand greater than 200,000 abrasion cycles without wearing through the fabric at any location.

Partek "PS" can withstand greater than 50,000 abrasion cycles. In addition, this weave also gives an exceptionally smooth interior wall, allowing rubber hose to move freely inside the sleeve. This provides easy installation and prevents any internal abrasion problems. Partek sleeving is available in either black or yellow and in sizes to fit most hydraulic hose. Partek, the quick and easy solution to hose protection in high-abrasion areas.



view on web page

Partek Sleeve (Black) Part Number	Partek Sleeve (Yellow) Part Number	Partek PS Sleeve (Black) Part Number	Inside Dia.	
			A	B
AS-B-11	AS-Y-11		1.07	0.69
AS-B-13	AS-Y-13	PS-B-13	1.34	0.86
AS-B-15	AS-Y-15	PS-B-15	1.66	1.06
AS-B-17	AS-Y-17	PS-B-17	1.92	1.22
AS-B-19	AS-Y-19		2.12	1.35
AS-B-22	AS-Y-22	PS-B-22	2.24	1.42
AS-B-27	AS-Y-27		2.55	1.63
AS-B-33	AS-Y-33	PS-B-33	2.85	1.81
AS-B-35	AS-Y-35	PS-B-35	3.43	2.19
AS-B-37	AS-Y-37	PS-B-37	3.73	2.38
		PS-B-39	4.12	2.63
		PS-B-45	4.53	2.88
AS-B-47		PS-B-47	4.90	3.13
AS-B-58			5.69	3.63
AS-B-64			6.81	4.00

## PolyGuard

Parker's PolyGuard is a black, heavy-duty polyethylene shield that provides protection in rugged operating conditions. PolyGuard is used to prevent hose assemblies from abrasion and cuts while also minimizing kinking of the hose. PolyGuard can be used to bundle high-pressured hose lines.

PolyGuard can be installed without removing hose lines and without the use of clamps for easy installation. This shield resists water, oil, gasoline, hydraulic fluid and most solvents.

Use the formula below to determine the length of sleeve required.

Temperature Range: 0°F to +200°F (-17°C to +93°C)

**Caution:** This material will support combustion.

$$\frac{\text{Hose O.D.} \times \text{Length to be Protected}}{\text{Dimension A}} + \text{Dimension B}$$



view on web page

Part Number	Inside Diameter "A" (inch)	Coil Width "B" (inch)
HG-075	0.75	0.95
HG-100	1.00	1.25
HG-125	1.25	1.35
HG-150	1.50	1.50
HG-200	2.00	1.60
HG-350	3.50	1.95

**WARNING:** This product can expose you to chemicals including N-Hexane, which is known to the State of California to cause birth defects or other reproductive harm. For more information go to [www.p65warnings.ca.gov](http://www.p65warnings.ca.gov).

## ParKoil

Parker's ParKoil is a lower-cost protection shield for applications that call for a tighter bend radius and are less demanding. ParKoil is easy to install and is used to prevent hose assemblies from abrasion and cuts while also minimizing kinking of the hose. ParKoil is great for bundling high-pressured hose lines.

Use the formula below to determine the length of sleeve required.

Temperature Range: 0°F to +200°F (-17°C to +93°C)

**Caution:** This material will support combustion.

$$\frac{\text{Hose O.D.} \times \text{Length to be Protected}}{\text{Dimension A}} + \text{Dimension B}$$



view on web page

Part Number	Inside Diameter "A" (inch)	Coil Width "B" (inch)
PG-038	0.38	0.25
PG-050	0.50	0.40
PG-062	0.62	0.40
PG-075	0.75	0.40
PG-088	0.88	0.40
PG-100	1.00	0.65
PG-119	1.19	0.65
PG-138	1.38	0.65
PG-188	1.88	0.65

See pages D-26 through D-32 for sleeve selection guide.

# Protective Coils, Sleeves & Guards

## Spring Guard

Parker's Spring Guard prolongs the life of hose lines that are exposed to rugged operating conditions by distributing bending radii to avoid kinking in the hose lines and protects hose from abrasion and deep cuts. Guards are constructed of steel wire and plated to resist rust.

Spring Guard is packaged in 10 ft. pieces.



view on web page

## Polyguard Strain Reliever

The Polyguard Strain Reliever is designed to limit kinking of hose assemblies. These strain relievers are made from flexible PVC making them easy to install and use.

Temperature Range: -40°F to +225°F  
(-40°C to +107°C)



view on web page

Spring Guard Part Number	Inside Diameter
SG-060	0.60
SG-072	0.72
SG-084	0.84
SG-097	0.97
SG-113	1.13
SG-122	1.22
SG-131	1.32
SG-155	1.55
SG-182	1.82
SG-209	2.09
SG-232	2.32
SG-292	2.92

Part Number	Length (inch)	Hose O.D. (inch)
4PG	7	0.53
6PG	7	0.63
7PG	7	0.69

**⚠️ WARNING:** This product can expose you to chemicals including DNP, which is known to the State of California to cause cancer. For more information go to [www.p65warnings.ca.gov](http://www.p65warnings.ca.gov).



# Firesleeve (FS-F)

Parker Firesleeve is a flame resistant sheath that protects the hose from extreme temperature conditions. Firesleeve easily slides over hoses and readily expands over fitting. It can be assembled with Parker FSC or properly sized wormgear clamp.

**Temperature Range:** -65°F to +500°F (-54°C to +260°C) continuous exposure, up to 2000°F (1093°C) for 15-20 minutes and up to 3000°F (1650°C) for 15-30 seconds.

**Note:** The Firesleeve inside dimension (I.D.) must exceed the outside diameter (O.D.) of the hose and offer an allowance for easy hose insertion. For example, 201-16 has a 1.23 in. O.D. FS-S-24, with an I.D. of 1.46 in., is the suggested Firesleeve.

**Construction:** Braided fiberglass sleeve and an orange, bonded and seamless silicone rubber cover.

**Specifications:** Conforms to SAE Aerospace Standard 1072E.



**Firesleeve (FS-F)**

[view on web page](#)



**FSC Clamp (FSC)**  
(One size fits all hoses up to 2 inch O.D.)

[view on web page](#)



**Firesleeve Tape (FSS-Tape-16)**

[view on web page](#)

## Certifications and Specifications

- UL 1441 Certified
- VW1 Flame Test Certified
- MSHA Certified for use in underground mines
- SAE AS1072E
- DNV-GL Certified to 800°C/30 mins. (ISO15540 & ISO15541)
- BS EN 373 Molten Splash Tested
- BS EN 388 Abrasion Tested
- BS EN ISO 6940 Flame Resistance Tested
- BS EN ISO 6530 Oil Resistance Tested
- BS 2576 Tensile Strength Tested
- DIN 45545 Low Smoke Toxicity
- DIN 54837 / 5510-2 Rail Vehicle Certified for Resistance to Combustibility
- DIN 5659-2 /5510-2 Rail Vehicle Certified for Toxicity
- LNE French Rail Certification STM-S-001; Class F0
- DIN EN45545-2:2013-08 Rail Certification
- Oil and Fluid Resistance: Impervious to most liquids including those with a hydrocarbon base. Remains functional after immersion for 120 hours at 80°F in MIL-L-6082 and Skydrol 500.

## FS-F Sizes

Part Number	Inside Diameter
FS-F-10	0.58
FS-F-11	0.65
FS-F-12	0.71
FS-F-14	0.84
FS-F-16	0.96
FS-F-18	1.08
FS-F-20	1.21
FS-F-22	1.34
FS-F-24	1.46
FS-F-28	1.72
FS-F-30	1.84
FS-F-32	1.96
FS-F-38	2.34
FS-F-40	2.46
FS-F-48	2.96
FS-F-60	3.71

**WARNING:** This product can expose you to chemicals including respirable glass fibers, which is known to the State of California to cause cancer. For more information go to [www.p65warnings.ca.gov](http://www.p65warnings.ca.gov).

## Firesleeve Assembly Instructions

1. Cut Firesleeve to the same length as hose.
2. Crimp one end of hose. Slide Firesleeve over uncrimped end of hose.
3. Push Firesleeve back from uncrimped end of hose and crimp second fitting on hose. Align the Firesleeve so it covers the crimp shell on both ends.
4. Using FSS-Tape-16, tape Firesleeve to fittings making sure to cover all exposed ends of the Firesleeve fiber. Repeat on the other end.
5. Clamp Firesleeve in place using the FSC Clamp.

**Note:** If assembling with Firesleeve tape, please stretch tape during installation using at least a 50% overlap. For best results, use on clean, dry surfaces free from dirt and oil.

# Protection Shields

Prevent hose abrasion while extending your hose life. Parker Hose Protection Shields extend hose life by protecting the hose from abrasion that occurs when hose rubs against other hose, metal or concrete. Parker hose shields are resistant to oil, lubricants, gasoline, most solvents and can withstand ambient temperatures from -40° to +300° F. Easily installed and secured by cable ties without disconnecting any hose lines. Use with hose from 1/4" to 2" I.D.

## Assembly Instructions

These flexible protectors simply clamp around the hose and are securely held in place by nylon cable ties which are included. The cable ties are recessed in molded grooves to protect them from abrasion. **You don't need to disconnect a line to install a Parker Hose Protector Shield the way you do with a continuous tubular sleeve. Just wait until the installation is up and running to see exactly where contact needs to be prevented.**

Parker Hose Protector Shields are available in bulk quantities and in convenient assortments in 4", 6" and 8" sizes. Cable ties are included with all protectors and are also available in bulk.

## Retail Counter Display

Part number: HP-B-13X18

Kit Includes:	
20 - 4" Hose Protectors (HP-B-13)	
60 - Tie Wraps (HT-12) for HP-B-13	
20 - 6" Hose Protectors (HP-B-15)	
60 - Tie Wraps (HT-16) for HP-B-15	
20 - 8" Hose Protectors (HP-B-18)	
60 - Tie Wraps (HT-22) for HP-B-18	

## Display Refills

Part Number	Description
HP-B-13-RFL	10 - 4" Hose Protectors (HP-B-13) 30 - Tie Wraps (HT-12)
HP-B-15-RFL	10 - 6" Hose Protectors (HP-B-15) 30 - Tie Wraps (HT-16)
HP-B-18-RFL	5 - 8" Hose Protectors (HP-B-18) 15 - Tie Wraps (HT-22)
HT-12-KIT	30 - Tie Wraps (HT-12) for HP-B-13 Hose Protector
HT-16-KIT	30 - Tie Wraps (HT-16) for HP-B-15 Hose Protector
HT-22-KIT	15 - Tie Wraps (HT-22) for HP-B-18 Hose Protector

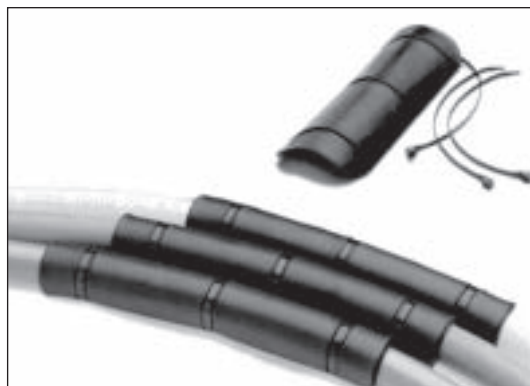

[view on web page](#)



Retail Counter Display

**Note:** Parker Hose Protector Shield products are intended to prevent damage. They are not suitable as patches or repairs for lines which are already damaged or worn beyond safe use standards.



# Protective Coils, Sleeves & Guards Selection Guide

Hose Part Number	Hose OD (in)	Partek Defense	Partek Sleeve: Black	Partek Sleeve: Yellow	Partek PS Sleeve Black	PolyGuard	ParKoil	Spring Guard	Firesleeve
187-8	0.810	YS-B-22	AS-B-15	AS-Y-15	PS-B-15	HG-125	PG-088	SG-084	FS-F-14
187-10	0.93	YS-B-27	AS-B-17	AS-Y-17	PS-B-17	HG-125	PG-100	SG-097	FS-F-16
187-12	1.08	YS-B-33	AS-B-19	AS-Y-19	-	HG-125	PG-119	SG-113	FS-F-20
187-16	1.41	YS-B-37	AS-B-27	AS-Y-27	PS-B-33	HG-150	PG-188	SG-155	FS-F-24
187-20	1.75	-	AS-B-35	AS-Y-35	PS-B-35	HG-200	PG-188	SG-182	FS-F-30
187-24	2.04	-	AS-B-37	AS-Y-37	PS-B-37	HG-350	PG-188	SG-209	FS-F-38
187-32	2.54	-	AS-B-47	-	PS-B-47	HG-350	PG-188	SG-292	FS-F-48
187-40	2.97	-	AS-B-58	-	-	HG-350	PG-188	-	-
187-48	3.44	-	AS-B-64	-	-	HG-350	PG-188	-	-
201-4	0.52	-	AS-B-13	AS-Y-13	PS-B-13	HG-075	PG-062	SG-060	FS-F-10
201-5	0.582	-	AS-B-13	AS-Y-13	PS-B-13	HG-075	PG-062	SG-060	FS-F-11
201-6	0.675	-	AS-B-13	AS-Y-13	PS-B-13	HG-075	PG-075	SG-072	FS-F-12
201-8	0.766	-	AS-B-15	AS-Y-15	PS-B-15	HG-125	PG-088	SG-084	FS-F-14
201-10	0.922	-	AS-B-17	AS-Y-17	PS-B-17	HG-125	PG-100	SG-097	FS-F-16
201-12	1.078	-	AS-B-19	AS-Y-19	-	HG-125	PG-119	SG-113	FS-F-18
201-16	1.235	-	AS-B-22	AS-Y-22	PS-B-22	HG-125	PG-138	SG-131	FS-F-22
201-20	1.5	-	AS-B-33	AS-Y-33	PS-B-33	HG-150	PG-188	SG-155	FS-F-28
201-24	1.75	-	AS-B-35	AS-Y-35	PS-B-35	HG-200	PG-188	SG-182	FS-F-30
201-32	2.22	-	-	-	PS-B-39	HG-350	PG-188	SG-232	FS-F-38
201-40	2.88	-	AS-B-47	-	PS-B-47	HG-350	PG-188	SG-292	FS-F-48
201-48	3.56	-	AS-B-64	-	-	HG-350	PG-188	-	FS-F-60
206-4	0.52	-	AS-B-13	AS-Y-13	PS-B-13	HG-075	PG-062	SG-060	FS-F-10
206-5	0.58	-	AS-B-13	AS-Y-13	PS-B-13	HG-075	PG-062	SG-060	FS-F-10
206-6	0.68	-	AS-B-13	AS-Y-13	PS-B-13	HG-075	PG-075	SG-072	FS-F-12
206-8	0.77	-	AS-B-15	AS-Y-15	PS-B-15	HG-125	PG-088	SG-084	FS-F-14
206-10	0.92	-	AS-B-17	AS-Y-17	PS-B-17	HG-125	PG-100	SG-097	FS-F-16
206-12	1.08	-	AS-B-19	AS-Y-19	-	HG-125	PG-119	SG-113	FS-F-18
206-16	1.23	-	AS-B-22	AS-Y-22	PS-B-22	HG-125	PG-138	SG-131	FS-F-22
206-20	1.5	-	AS-B-33	AS-Y-33	PS-B-33	HG-150	PG-188	SG-155	FS-F-28
206-24	1.75	-	AS-B-35	AS-Y-35	PS-B-35	HG-200	PG-188	SG-182	FS-F-30
206-32	2.22	-	-	-	PS-B-39	HG-350	PG-188	SG-232	FS-F-38
206-40	2.88	-	AS-B-47	-	PS-B-47	HG-350	PG-188	SG-292	FS-F-48
213-4	0.49	-	AS-B-11	AS-Y-11	-	HG-075	PG-050	-	FS-F-10
213-5	0.55	-	AS-B-13	AS-Y-13	PS-B-13	HG-075	PG-062	SG-060	FS-F-10
213-6	0.62	-	AS-B-13	AS-Y-13	PS-B-13	HG-075	PG-062	-	FS-F-11
213-8	0.74	-	AS-B-15	AS-Y-15	PS-B-15	HG-075	PG-075	SG-084	FS-F-14
213-10	0.83	-	AS-B-15	AS-Y-15	PS-B-15	HG-125	PG-088	SG-084	FS-F-14
213-12	0.96	-	AS-B-17	AS-Y-17	PS-B-17	HG-125	PG-100	SG-097	FS-F-16
213-16	1.21	-	AS-B-22	AS-Y-22	PS-B-22	HG-125	PG-138	SG-122	FS-F-20

**NOTES:** "X" indicates there is no recommended sleeve because the sleeve supports combustion.  
 Sizes indicated are suggestions only and based on hose O.D. A larger size may be required for over fitting applications.  
 Suggestions indicated are for standard, ToughCover, and SuperTough cover options.

# Protective Coils, Sleeves & Guards Selection Guide

Hose Part Number	Hose OD (in)	Partek Defense	Partek Sleeve: Black	Partek Sleeve: Yellow	Partek PS Sleeve Black	PolyGuard	ParKoil	Spring Guard	Firesleeve
213-20	1.49	-	AS-B-33	AS-Y-33	PS-B-33	HG-150	PG-188	SG-155	FS-F-28
213-24	1.73	-	AS-B-35	AS-Y-35	PS-B-35	HG-200	PG-188	SG-182	FS-F-30
213-32	2.14	-	AS-B-37	AS-Y-37	PS-B-37	HG-350	PG-188	-	FS-F-38
213-40	2.88	-	AS-B-47	-	PS-B-47	HG-350	PG-188	SG-292	FS-F-48
221FR-5	0.582	X	X	X	X	X	X	SG-060	FS-F-11
221FR-6	0.676	X	X	X	X	X	X	SG-072	FS-F-12
221FR-8	0.766	X	X	X	X	X	X	SG-084	FS-F-14
221FR-10	0.922	X	X	X	X	X	X	SG-097	FS-F-16
221FR-12	1.078	X	X	X	X	X	X	SG-113	FS-F-18
221FR-16	1.235	X	X	X	X	X	X	SG-131	FS-F-22
244-16	1.23	-	AS-B-22	AS-Y-22	PS-B-22	HG-125	PG-138	SG-131	FS-F-22
244-20	1.5	-	AS-B-33	AS-Y-33	PS-B-33	HG-150	PG-188	SG-155	FS-F-28
244-24	1.75	-	AS-B-35	AS-Y-35	PS-B-35	HG-200	PG-188	SG-182	FS-F-30
266-4	0.52	-	AS-B-13	AS-Y-13	PS-B-13	HG-075	PG-062	SG-060	FS-F-10
266-5	0.58	-	AS-B-13	AS-Y-13	PS-B-13	HG-075	PG-062	SG-060	FS-F-10
266-6	0.68	-	AS-B-13	AS-Y-13	PS-B-13	HG-075	PG-075	SG-072	FS-F-12
266-8	0.77	-	AS-B-15	AS-Y-15	PS-B-15	HG-125	PG-088	SG-084	FS-F-14
266-10	0.92	-	AS-B-17	AS-Y-17	PS-B-17	HG-125	PG-100	SG-097	FS-F-16
266-12	1.08	-	AS-B-19	AS-Y-19	-	HG-125	PG-119	SG-113	FS-F-18
266-16	1.24	-	AS-B-22	AS-Y-22	PS-B-22	HG-125	PG-138	SG-131	FS-F-22
266-20	1.5	-	AS-B-33	AS-Y-33	PS-B-33	HG-150	PG-188	SG-155	FS-F-28
266-24	1.75	-	AS-B-35	AS-Y-35	PS-B-35	HG-200	PG-188	SG-182	FS-F-30
271-4	0.25	-	AS-B-11	AS-Y-11	-	HG-075	PG-038	-	FS-F-10
271-6	0.75	-	AS-B-15	AS-Y-15	PS-B-15	HG-075	PG-075	SG-084	FS-F-14
271-8	0.88	-	AS-B-17	AS-Y-17	PS-B-17	HG-125	PG-088	SG-097	FS-F-16
285-4	0.49	-	AS-B-11	AS-Y-11	-	HG-075	PG-050	-	FS-F-10
285-6	0.62	-	AS-B-13	AS-Y-13	PS-B-13	HG-075	PG-062	-	FS-F-11
285-8	0.68	-	AS-B-13	AS-Y-13	PS-B-13	HG-075	PG-075	SG-072	FS-F-12
285-10	0.83	-	AS-B-15	AS-Y-15	PS-B-15	HG-125	PG-088	SG-084	FS-F-14
285-12	0.96	-	AS-B-17	AS-Y-17	PS-B-17	HG-125	PG-100	SG-097	FS-F-16
293-4	0.491	-	AS-B-11	AS-Y-11	-	HG-075	PG-050	-	FS-F-10
293-6	0.617	-	AS-B-13	AS-Y-13	PS-B-13	HG-075	PG-062	-	FS-F-11
293-8	0.737	-	AS-B-15	AS-Y-15	PS-B-15	HG-075	PG-075	SG-084	FS-F-14
293-10	0.831	-	AS-B-15	AS-Y-15	PS-B-15	HG-125	PG-088	SG-084	FS-F-14
293-12	0.956	-	AS-B-17	AS-Y-17	PS-B-17	HG-125	PG-100	SG-097	FS-F-16
293-16	1.206	-	AS-B-22	AS-Y-22	PS-B-22	HG-125	PG-138	SG-122	FS-F-20
302-4	0.591	YS-B-17	AS-B-13	AS-Y-13	PS-B-13	HG-075	PG-062	SG-060	FS-F-11
302-5	0.654	-	AS-B-13	AS-Y-13	PS-B-13	HG-075	PG-075	-	FS-F-12
302-6	0.748	YS-B-19	AS-B-15	AS-Y-15	PS-B-15	HG-075	PG-075	SG-084	FS-F-14

**NOTES:** "X" indicates there is no recommended sleeve because the sleeve supports combustion.  
 Sizes indicated are suggestions only and based on hose O.D. A larger size may be required for over fitting applications.  
 Suggestions indicated are for standard, ToughCover, and SuperTough cover options.



# Protective Coils, Sleeves & Guards Selection Guide

Hose Part Number	Hose OD (in)	Partek Defense	Partek Sleeve: Black	Partek Sleeve: Yellow	Partek PS Sleeve Black	PolyGuard	ParKoil	Spring Guard	Firesleeve
302-8	0.876	YS-B-22	AS-B-15	AS-Y-15	PS-B-15	HG-125	PG-088	SG-097	FS-F-16
302-10	1.002	YS-B-27	AS-B-17	AS-Y-17	PS-B-17	HG-125	PG-119	-	FS-F-18
302-12	1.156	YS-B-33	AS-B-19	AS-Y-19	-	HG-125	PG-119	SG-122	FS-F-20
302-16	1.5	YS-B-37	AS-B-33	AS-Y-33	PS-B-33	HG-150	PG-188	SG-155	FS-F-28
302-20	1.86	-	AS-B-35	AS-Y-35	PS-B-35	HG-200	PG-188	SG-209	FS-F-32
302-24	2.14	-	AS-B-37	AS-Y-37	PS-B-37	HG-350	PG-188	-	FS-F-38
302-32	2.64	-	AS-B-47	-	PS-B-45	HG-350	PG-188	SG-292	FS-F-48
304-4	0.591	YS-B-17	AS-B-13	AS-Y-13	PS-B-13	HG-075	PG-062	SG-060	FS-F-11
304-6	0.748	YS-B-19	AS-B-15	AS-Y-15	PS-B-15	HG-075	PG-075	SG-084	FS-F-14
304-8	0.876	YS-B-22	AS-B-17	AS-Y-17	PS-B-17	HG-125	PG-088	SG-097	FS-F-16
304-10	1.002	YS-B-27	AS-B-17	AS-Y-17	PS-B-17	HG-125	PG-119	-	FS-F-18
304-12	1.156	YS-B-33	AS-B-19	AS-Y-19	-	HG-125	PG-119	SG-122	FS-F-20
304-16	1.5	YS-B-37	AS-B-33	AS-Y-33	PS-B-33	HG-150	PG-188	SG-155	FS-F-28
304-20	1.86	-	AS-B-35	AS-Y-35	PS-B-35	HG-200	PG-188	SG-209	FS-F-32
304-24	2.14	-	AS-B-37	AS-Y-37	PS-B-37	HG-350	PG-188	-	FS-F-38
304-32	2.64	-	AS-B-47	-	PS-B-45	HG-350	PG-188	SG-292	FS-F-48
387-4	0.526	YS-B-17	AS-B-13	AS-Y-13	PS-B-13	HG-075	PG-062	SG-060	FS-F-10
387-6	0.685	YS-B-19	AS-B-15	AS-Y-15	PS-B-15	HG-075	PG-075	SG-072	FS-F-12
387-8	0.815	YS-B-22	AS-B-15	AS-Y-15	PS-B-15	HG-125	PG-088	SG-084	FS-F-14
387-10	0.939	YS-B-27	AS-B-17	AS-Y-17	PS-B-17	HG-125	PG-100	SG-097	FS-F-16
387-12	1.093	YS-B-33	AS-B-19	AS-Y-19	-	HG-125	PG-119	SG-113	FS-F-20
387-16	1.394	YS-B-37	AS-B-27	AS-Y-27	-	HG-150	PG-188	SG-155	FS-F-24
387-20	1.82	-	AS-B-35	AS-Y-35	PS-B-35	HG-200	PG-188	SG-182	FS-F-30
387-24	2.08	-	AS-B-37	AS-Y-37	PS-B-37	HG-350	PG-188	SG-209	FS-F-38
387-32	2.61	-	AS-B-47	-	PS-B-45	HG-350	PG-188	SG-292	FS-F-48
422-4	0.528	YS-B-17	AS-B-13	AS-Y-13	PS-B-13	HG-075	PG-062	SG-060	FS-F-10
422-5	0.591	-	AS-B-13	AS-Y-13	PS-B-13	HG-075	PG-062	SG-060	FS-F-11
422-6	0.685	YS-B-19	AS-B-13	AS-Y-13	PS-B-13	HG-075	PG-075	SG-072	FS-F-12
422-8	0.81	YS-B-22	AS-B-15	AS-Y-15	PS-B-15	HG-125	PG-088	SG-084	FS-F-14
422-10	0.939	YS-B-27	AS-B-17	AS-Y-17	PS-B-17	HG-125	PG-100	SG-097	FS-F-16
422-12	1.095	YS-B-33	AS-B-19	AS-Y-19	-	HG-125	PG-119	SG-113	FS-F-20
422-16	1.41	YS-B-37	AS-B-27	AS-Y-27	-	HG-150	PG-188	SG-155	FS-F-24
422-20	1.79	-	AS-B-35	AS-Y-35	PS-B-35	HG-200	PG-188	SG-182	FS-F-30
422-24	2	-	AS-B-35	AS-Y-35	PS-B-35	HG-200	PG-188	SG-209	FS-F-38
422-32	2.54	-	AS-B-47	-	PS-B-39	HG-350	PG-188	SG-292	FS-F-48
424-16	1.41	YS-B-37	AS-B-27	AS-Y-27	-	HG-150	PG-188	SG-155	FS-F-24
424-20	1.73	-	AS-B-35	AS-Y-35	PS-B-35	HG-200	PG-188	SG-182	FS-F-30
424-24	2	-	AS-B-35	AS-Y-35	PS-B-35	HG-200	PG-188	SG-209	FS-F-38
424-32	2.5	-	AS-B-47	-	PS-B-39	HG-350	PG-188	SG-292	FS-F-48

**NOTES:** "X" indicates there is no recommended sleeve because the sleeve supports combustion.  
 Sizes indicated are suggestions only and based on hose O.D. A larger size may be required for over fitting applications.  
 Suggestions indicated are for standard, ToughCover, and SuperTough cover options.



# Protective Coils, Sleeves & Guards Selection Guide

Hose Part Number	Hose OD (in)	Partek Defense	Partek Sleeve: Black	Partek Sleeve: Yellow	Partek PS Sleeve Black	PolyGuard	ParKoil	Spring Guard	Firesleeve
426-4	0.528	YS-B-17	AS-B-13	AS-Y-13	PS-B-13	HG-075	PG-062	SG-060	FS-F-10
426-6	0.68	YS-B-19	AS-B-13	AS-Y-13	PS-B-13	HG-075	PG-075	SG-072	FS-F-12
426-8	0.81	YS-B-22	AS-B-15	AS-Y-15	PS-B-15	HG-125	PG-088	SG-084	FS-F-14
426-10	0.94	YS-B-27	AS-B-17	AS-Y-17	PS-B-17	HG-125	PG-100	SG-097	FS-F-16
426-12	1.09	YS-B-33	AS-B-19	AS-Y-19	-	HG-125	PG-119	SG-113	FS-F-20
426-16	1.4	YS-B-37	AS-B-27	AS-Y-27	-	HG-150	PG-188	SG-155	FS-F-24
426-20	1.79	-	AS-B-35	AS-Y-35	PS-B-35	HG-200	PG-188	SG-182	FS-F-30
426-24	2	-	AS-B-35	AS-Y-35	PS-B-35	HG-200	PG-188	SG-209	FS-F-38
426-32	2.54	-	AS-B-47	-	PS-B-39	HG-350	PG-188	SG-292	FS-F-48
436-6	0.685	YS-B-19	AS-B-13	AS-Y-13	PS-B-13	HG-075	PG-075	SG-072	FS-F-12
436-8	0.815	YS-B-22	AS-B-15	AS-Y-15	PS-B-15	HG-125	PG-088	SG-084	FS-F-14
436-10	0.939	YS-B-27	AS-B-17	AS-Y-17	PS-B-17	HG-125	PG-100	SG-097	FS-F-16
436-12	1.095	YS-B-33	AS-B-19	AS-Y-19	-	HG-125	PG-119	SG-113	FS-F-20
436-16	1.41	YS-B-37	AS-B-27	AS-Y-27	-	HG-150	PG-188	SG-155	FS-F-24
471-4	0.516	YS-B-17	AS-B-13	AS-Y-13	PS-B-13	HG-075	PG-062	SG-060	FS-F-10
471-6	0.678	YS-B-19	AS-B-13	AS-Y-13	PS-B-13	HG-075	PG-075	SG-072	FS-F-12
471-8	0.804	YS-B-22	AS-B-15	AS-Y-15	PS-B-15	HG-125	PG-088	SG-084	FS-F-14
471-10	0.939	YS-B-27	AS-B-17	AS-Y-17	PS-B-17	HG-125	PG-100	SG-097	FS-F-16
471-12	1.093	YS-B-33	AS-B-19	AS-Y-19	-	HG-125	PG-119	SG-113	FS-F-20
471-16	1.394	YS-B-37	AS-B-27	AS-Y-27	-	HG-150	PG-188	SG-155	FS-F-24
472-20	1.79	-	AS-B-35	AS-Y-35	PS-B-35	HG-200	PG-188	SG-182	FS-F-30
472-24	2.01	-	AS-B-35	AS-Y-35	PS-B-35	HG-350	PG-188	SG-209	FS-F-38
472-32	2.54	-	AS-B-47	-	PS-B-39	HG-350	PG-188	SG-292	FS-F-48
472LT-4	0.516	YS-B-17	AS-B-13	AS-Y-13	PS-B-13	HG-075	PG-062	SG-060	FS-F-10
472LT-6	0.678	YS-B-19	AS-B-13	AS-Y-13	PS-B-13	HG-075	PG-075	SG-072	FS-F-12
472LT-8	0.804	YS-B-22	AS-B-15	AS-Y-15	PS-B-15	HG-125	PG-088	SG-084	FS-F-14
472LT-10	0.939	YS-B-27	AS-B-17	AS-Y-17	PS-B-17	HG-125	PG-100	SG-097	FS-F-16
472LT-12	1.093	YS-B-33	AS-B-19	AS-Y-19	-	HG-125	PG-119	SG-113	FS-F-20
472LT-16	1.394	YS-B-37	AS-B-27	AS-Y-27	-	HG-150	PG-188	SG-155	FS-F-24
482-4	0.528	YS-B-17	AS-B-13	AS-Y-13	PS-B-13	HG-075	PG-062	SG-060	FS-F-10
482-6	0.685	YS-B-19	AS-B-13	AS-Y-13	PS-B-13	HG-075	PG-075	SG-072	FS-F-12
482-8	0.815	YS-B-22	AS-B-15	AS-Y-15	PS-B-15	HG-125	PG-088	SG-084	FS-F-14
482-10	0.939	YS-B-27	AS-B-17	AS-Y-17	PS-B-17	HG-125	PG-100	SG-097	FS-F-16
482-12	1.095	YS-B-33	AS-B-19	AS-Y-19	-	HG-125	PG-119	SG-113	FS-F-20
482-16	1.41	YS-B-37	AS-B-27	AS-Y-27	-	HG-150	PG-188	SG-155	FS-F-24
487-4	0.516	YS-B-17	AS-B-13	AS-Y-13	PS-B-13	HG-075	PG-062	SG-060	FS-F-10
487-6	0.678	YS-B-19	AS-B-13	AS-Y-13	PS-B-13	HG-075	PG-075	SG-072	FS-F-12
487-8	0.804	YS-B-22	AS-B-15	AS-Y-15	PS-B-15	HG-125	PG-088	SG-084	FS-F-14
487-10	0.939	YS-B-27	AS-B-17	AS-Y-17	PS-B-17	HG-125	PG-100	SG-097	FS-F-16

**NOTES:** "X" indicates there is no recommended sleeve because the sleeve supports combustion.  
 Sizes indicated are suggestions only and based on hose O.D. A larger size may be required for over fitting applications.  
 Suggestions indicated are for standard, ToughCover, and SuperTough cover options.

A

B

C

D

E

# Protective Coils, Sleeves & Guards Selection Guide

Hose Part Number	Hose OD (in)	Partek Defense	Partek Sleeve: Black	Partek Sleeve: Yellow	Partek PS Sleeve Black	PolyGuard	ParKoil	Spring Guard	Firesleeve
487-12	1.093	YS-B-33	AS-B-19	AS-Y-19	-	HG-125	PG-119	SG-113	FS-F-20
487-16	1.49	YS-B-37	AS-B-33	AS-Y-33	PS-B-33	HG-150	PG-188	SG-155	FS-F-28
487-20	1.82	-	AS-B-35	AS-Y-35	PS-B-35	HG-200	PG-188	SG-182	FS-F-30
487-24	2.03	-	AS-B-37	AS-Y-37	PS-B-37	HG-350	PG-188	SG-209	FS-F-38
487-32	2.65	-	AS-B-47	-	PS-B-45	HG-350	PG-188	SG-292	FS-F-48
611HT-4	0.5	-	AS-B-11	AS-Y-11	-	HG-075	PG-050	-	FS-F-10
611HT-6	0.625	-	AS-B-13	AS-Y-13	PS-B-13	HG-075	PG-075	-	FS-F-11
611HT-8	0.781	-	AS-B-15	AS-Y-15	PS-B-15	HG-125	PG-088	SG-084	FS-F-14
611HT-10	0.907	-	AS-B-17	AS-Y-17	PS-B-17	HG-125	PG-100	SG-097	FS-F-16
611HT-12	1.032	-	AS-B-17	AS-Y-17	PS-B-17	HG-125	PG-119	-	FS-F-18
722-6	0.78	YS-B-19	AS-B-15	AS-Y-15	PS-B-15	HG-125	PG-088	SG-084	FS-F-14
722-8	0.89	YS-B-22	AS-B-17	AS-Y-17	PS-B-17	HG-125	PG-100	SG-097	FS-F-16
722-10	1.04	YS-B-27	AS-B-17	AS-Y-17	PS-B-17	HG-125	PG-119	-	FS-F-18
722-12	1.21	YS-B-33	AS-B-19	AS-Y-19	-	HG-125	PG-138	SG-122	FS-F-20
722-16	1.5	YS-B-37	AS-B-33	AS-Y-33	PS-B-33	HG-150	PG-188	SG-155	FS-F-28
722-20	1.84	-	AS-B-35	AS-Y-35	PS-B-35	HG-200	PG-188	SG-209	FS-F-30
722-24	2.07	-	AS-B-37	AS-Y-37	PS-B-37	HG-350	PG-188	SG-209	FS-F-38
722-32	2.59	-	AS-B-47	-	PS-B-39	HG-350	PG-188	SG-292	FS-F-48
722LT-6	0.782	YS-B-19	AS-B-15	AS-Y-15	PS-B-15	HG-125	PG-088	SG-084	FS-F-14
722LT-8	0.892	YS-B-22	AS-B-17	AS-Y-17	PS-B-17	HG-125	PG-100	SG-097	FS-F-16
722LT-10	1.04	YS-B-27	AS-B-17	AS-Y-17	PS-B-17	HG-125	PG-119	-	FS-F-18
722LT-12	1.207	YS-B-33	AS-B-19	AS-Y-19	-	HG-125	PG-138	SG-122	FS-F-20
722LT-16	1.49	YS-B-37	AS-B-33	AS-Y-33	PS-B-33	HG-150	PG-188	SG-155	FS-F-28
722LT-20	1.82	-	AS-B-35	AS-Y-35	PS-B-35	HG-200	PG-188	SG-182	FS-F-30
722LT-24	2.06	-	AS-B-37	AS-Y-37	PS-B-37	HG-350	PG-188	SG-209	FS-F-38
774-12	1.207	YS-B-33	AS-B-19	AS-Y-19	-	HG-125	PG-138	SG-122	FS-F-20
774-16	1.5	YS-B-37	AS-B-33	AS-Y-33	PS-B-33	HG-150	PG-188	SG-155	FS-F-28
774-20	1.84	-	AS-B-35	AS-Y-35	PS-B-35	HG-200	PG-188	SG-209	FS-F-30
774-24	2.07	-	AS-B-37	AS-Y-37	PS-B-37	HG-350	PG-188	SG-209	FS-F-38
774-32	2.59	-	AS-B-47	-	PS-B-39	HG-350	PG-188	SG-292	FS-F-48
777-6	0.66	YS-B-19	AS-B-13	AS-Y-13	PS-B-13	HG-075	PG-075	-	FS-F-12
777-8	0.81	YS-B-19	AS-B-15	AS-Y-15	PS-B-15	HG-100	PG-088	SG-097	FS-F-16
777-10	0.93	YS-B-27	AS-B-17	AS-Y-17	PS-B-17	HG-125	PG-100	SG-113	FS-F-18
777-12	1.12	YS-B-33	AS-B-15	AS-Y-15	PS-B-15	HG-100	PG-138	SG-122	FS-F-20
777TC-12	1.12	YS-B-33	AS-B-15	AS-Y-15	PS-B-15	HG-100	PG-138	SG-122	FS-F-20
777ST-12	1.12	YS-B-33	AS-B-15	AS-Y-15	PS-B-15	HG-100	PG-138	SG-122	FS-F-20
777-16	1.38	YS-B-37	AS-B-17	AS -Y-17	PS-B-17	HG-150	PG -188	SG-155	FS-F-24
777TC-16	1.38	YS-B-37	AS-B-17	AS -Y-17	PS-B-17	HG-150	PG -188	SG-155	FS-F-24
777ST-16	1.38	YS-B-37	AS-B-17	AS -Y-17	PS-B-17	HG-150	PG -188	SG-155	FS-F-24
787-4	0.516	YS-B-17	AS-B-13	AS-Y-13	PS-B-13	HG-075	PG-062	SG-060	FS-F-10

**NOTES:** "X" indicates there is no recommended sleeve because the sleeve supports combustion.  
 Sizes indicated are suggestions only and based on hose O.D. A larger size may be required for over fitting applications.  
 Suggestions indicated are for standard, ToughCover, and SuperTough cover options

# Protective Coils, Sleeves & Guards Selection Guide

Hose Part Number	Hose OD (in)	Partek Defense	Partek Sleeve: Black	Partek Sleeve: Yellow	Partek PS Sleeve Black	PolyGuard	ParKoil	Spring Guard	Firesleeve
787-6	0.68	YS-B-19	AS-B-13	AS-Y-13	PS-B-13	HG-075	PG-075	SG-072	FS-F-12
787-8	0.83	YS-B-22	AS-B-15	AS-Y-15	PS-B-15	HG-125	PG-088	SG-084	FS-F-14
787-10	0.94	YS-B-27	AS-B-17	AS-Y-17	PS-B-17	HG-125	PG-100	SG-097	FS-F-16
787-12	1.1	YS-B-33	AS-B-19	AS-Y-19	-	HG-125	PG-119	SG-113	FS-F-20
787-16	1.4	YS-B-37	AS-B-27	AS-Y-27	-	HG-150	PG-188	SG-155	FS-F-24
787-20	1.77	-	AS-B-35	AS-Y-35	PS-B-35	HG-200	PG-188	SG-182	FS-F-30
787-24	2.08	-	AS-B-37	AS-Y-37	PS-B-37	HG-350	PG-188	SG-209	FS-F-38
787-32	2.66	-	AS-B-47	-	PS-B-45	HG-350	PG-188	SG-292	FS-F-48
792LT-16	1.52	YS-B-37	AS-B-33	AS-Y-33	PS-B-33	HG-200	PG-188	SG-155	FS-F-28
792LT-20	1.97	-	AS-B-35	AS-Y-35	PS-B-35	HG-200	PG-188	SG-209	FS-F-38
792LT-24	2.22	-	-	-	PS-B-39	HG-350	PG-188	SG-232	FS-F-38
797-4	0.516	YS-B-17	AS-B-13	AS-Y-13	PS-B-13	HG-075	PG-062	SG-060	FS-F-10
797-6	0.66	YS-B-19	AS-B-13	AS-Y-13	PS-B-13	HG-075	PG-075	-	FS-F-12
797-8	0.83	YS-B-22	AS-B-15	AS-Y-15	PS-B-15	HG-125	PG-088	SG-084	FS-F-14
797-10	0.94	YS-B-27	AS-B-17	AS-Y-17	PS-B-17	HG-125	PG-100	SG-097	FS-F-16
797-12	1.1	YS-B-33	AS-B-19	AS-Y-19	-	HG-125	PG-119	SG-113	FS-F-20
797-16	1.4	YS-B-37	AS-B-27	AS-Y-27	-	HG-150	PG-188	SG-155	FS-F-24
797-20	1.77	-	AS-B-35	AS-Y-35	PS-B-35	HG-200	PG-188	SG-182	FS-F-30
797-24	2.08	-	AS-B-37	AS-Y-37	PS-B-37	HG-350	PG-188	SG-209	FS-F-38
797-32	2.66	-	AS-B-47	-	PS-B-45	HG-350	PG-188	SG-292	FS-F-48
801-4	0.5	-	AS-B-13	AS-Y-13	PS-B-13	HG-075	PG-050	-	FS-F-10
801-6	0.625	-	AS-B-13	AS-Y-13	PS-B-13	HG-075	PG-075	-	FS-F-11
801-8	0.781	-	AS-B-15	AS-Y-15	PS-B-15	HG-125	PG-088	SG-084	FS-F-14
801-10	0.907	-	AS-B-17	AS-Y-17	PS-B-17	HG-125	PG-100	SG-097	FS-F-16
801-12	1.032	-	AS-B-17	AS-Y-17	PS-B-17	HG-125	PG-119	-	FS-F-18
801-16	1.281	-	AS-B-27	AS-Y-27	-	HG-150	PG-138	SG-131	FS-F-22
804-4	0.5	-	AS-B-11	AS-Y-11	-	HG-075	PG-050	-	FS-F-10
804-6	0.625	-	AS-B-13	AS-Y-13	PS-B-13	HG-075	PG-075	-	FS-F-11
804-8	0.781	-	AS-B-15	AS-Y-15	PS-B-15	HG-125	PG-088	SG-084	FS-F-14
804-10	0.907	-	AS-B-17	AS-Y-17	PS-B-17	HG-125	PG-100	SG-097	FS-F-16
811-12	1.18	-	AS-B-27	AS-Y-27	-	HG-125	PG-119	SG-122	FS-F-20
811-16	1.5	-	AS-B-33	AS-Y-33	PS-B-33	HG-150	PG-188	SG-155	FS-F-28
811-20	1.77	-	AS-B-35	AS-Y-35	PS-B-35	HG-200	PG-188	SG-182	FS-F-30
811-24	2.05	-	AS-B-37	AS-Y-37	PS-B-37	HG-350	PG-188	SG-209	FS-F-38
811-32	2.5	-	AS-B-47	-	PS-B-39	HG-350	PG-188	SG-292	FS-F-48
811-40	3	-	AS-B-58	-	-	HG-350	PG-188	-	FS-F-60
811HT-12	1.18	-	AS-B-19	AS-Y-19	-	HG-125	PG-119	SG-122	FS-F-20
811HT-16	1.5	-	AS-B-33	AS-Y-33	PS-B-33	HG-150	PG-188	SG-155	FS-F-28
811HT-20	1.77	-	AS-B-35	AS-Y-35	PS-B-35	HG-200	PG-188	SG-182	FS-F-30
811HT-24	2.05	-	AS-B-37	AS-Y-37	PS-B-37	HG-350	PG-188	SG-209	FS-F-38

**NOTES:** "X" indicates there is no recommended sleeve because the sleeve supports combustion.  
 Sizes indicated are suggestions only and based on hose O.D. A larger size may be required for over fitting applications.  
 Suggestions indicated are for standard, ToughCover, and SuperTough cover options.

A

B

C

D

E

# Protective Coils, Sleeves & Guards Selection Guide

Hose Part Number	Hose OD (in)	Partek Defense	Partek Sleeve: Black	Partek Sleeve: Yellow	Partek PS Sleeve Black	PolyGuard	ParKoil	Spring Guard	Firesleeve
811HT-32	2.5	-	AS-B-47	-	PS-B-39	HG-350	PG-188	SG-292	FS-F-48
811HT-40	3	-	AS-B-58	-	-	HG-350	PG-188	-	FS-F-60
821-4	0.5	-	AS-B-11	AS-Y-11	-	HG-075	PG-050	-	FS-F-10
821-6	0.625	-	AS-B-13	AS-Y-13	PS-B-13	HG-075	PG-075	-	FS-F-11
821-8	0.781	-	AS-B-15	AS-Y-15	PS-B-15	HG-125	PG-088	SG-084	FS-F-14
821-10	0.907	-	AS-B-17	AS-Y-17	PS-B-17	HG-125	PG-100	SG-097	FS-F-16
821-12	1.03	-	AS-B-17	AS-Y-17	PS-B-17	HG-125	PG-119	-	FS-F-18
821FR-4	0.5	X	X	X	X	X	X	-	FS-F-10
821FR-6	0.625	X	X	X	X	X	X	-	FS-F-11
821FR-8	0.781	X	X	X	X	X	X	SG-084	FS-F-14
821FR-12	1.032	X	X	X	X	X	X	-	FS-F-18
836-4	0.5	-	AS-B-11	AS-Y-11	-	HG-075	PG-050	-	FS-F-10
836-6	0.625	-	AS-B-13	AS-Y-13	PS-B-13	HG-075	PG-075	-	FS-F-11
836-8	0.781	-	AS-B-15	AS-Y-15	PS-B-15	HG-125	PG-088	SG-084	FS-F-14
836-10	0.907	-	AS-B-17	AS-Y-17	PS-B-17	HG-125	PG-100	SG-097	FS-F-16
836-12	1.032	-	AS-B-17	AS-Y-17	PS-B-17	HG-125	PG-119	-	FS-F-18
881-12	1.2	-	AS-B-27	AS-Y-27	-	HG-125	PG-138	SG-122	FS-F-20
881-16	1.49	-	AS-B-33	AS-Y-33	PS-B-33	HG-150	PG-188	SG-155	FS-F-28
881-20	1.78	-	AS-B-35	AS-Y-35	PS-B-35	HG-200	PG-188	SG-182	FS-F-30
881-24	2.06	-	AS-B-37	AS-Y-37	PS-B-37	HG-350	PG-188	SG-209	FS-F-38
881-32	2.48	-	AS-B-47	-	PS-B-39	HG-350	PG-188	SG-292	FS-F-48
881-40	3	-	AS-B-58	-	-	HG-350	PG-188	-	FS-F-60
F42-8	0.969	YS-B-22	AS-B-17	AS-Y-17	PS-B-17	HG-125	PG-100	SG-097	FS-F-18
F42-12	1.264	YS-B-33	AS-B-27	AS-Y-27	-	HG-150	PG-138	SG-131	FS-F-22
F42-16	1.52	YS-B-37	AS-B-33	AS-Y-33	PS-B-33	HG-200	PG-188	SG-155	FS-F-28
F42-20	1.97	-	AS-B-35	AS-Y-35	PS-B-35	HG-200	PG-188	SG-209	FS-F-38
JK-4	0.59	YS-B-17	AS-B-13	AS-Y-13	PS-B-13	HG-075	PG-062	SG-060	FS-F-11
JK-6	0.75	YS-B-19	AS-B-15	AS-Y-15	PS-B-15	HG-075	PG-075	SG-084	FS-F-14
SS23CG-6	0.676	X	X	X	X	X	X	SG-072	FS-F-12
SS23CG-8	0.766	X	X	X	X	X	X	SG-084	FS-F-14
SS23CG-10	0.922	X	X	X	X	X	X	SG-097	FS-F-16
SS23CG-12	1.078	X	X	X	X	X	X	SG-113	FS-F-18
SS25UL-4	0.52	X	X	X	X	X	X	SG-060	FS-F-10
SS25UL-5	0.582	X	X	X	X	X	X	SG-060	FS-F-11
SS25UL-6	0.676	X	X	X	X	X	X	SG-072	FS-F-12
SS25UL-8	0.766	X	X	X	X	X	X	SG-084	FS-F-14
SS25UL-10	0.922	X	X	X	X	X	X	SG-097	FS-F-16
SS25UL-12	1.078	X	X	X	X	X	X	SG-113	FS-F-18

**NOTES:** "X" indicates there is no recommended sleeve because the sleeve supports combustion.  
 Sizes indicated are suggestions only and based on hose O.D. A larger size may be required for over fitting applications.  
 Suggestions indicated are for standard, ToughCover, and SuperTough cover options.

# Hose Whip Restraint

The Hose Whip Restraint System is designed to prevent whipping of a pressurized hose in the event of the hose separating from its fitting.

This system provides an additional level of safety and helps prevent damage to nearby equipment or injury to operators near the failed hose by limiting the whip or travel of the pressurized hose after it breaks free from its fitting.

Serious damage or injury can occur from whipping hoses, especially at higher pressures. The system is comprised of two parts – a hose collar and a cable assembly.

The hose collar (WRCxxxx) is selected based on the outside diameter of the hose, and the cable assembly is selected based on the type of hose connection.

Two types of cable assemblies are available – one for flange-type connections (WRFxxx), and the other for port adapters (WRAxxx).

The Hose Whip Restraint is not to be used in place of proper hose crimping procedures as outlined in Hose Products Division Catalog 4400. Exceeding the maximum operating pressure of the hose jeopardizes the proper operation of the Hose Whip Restraint System.

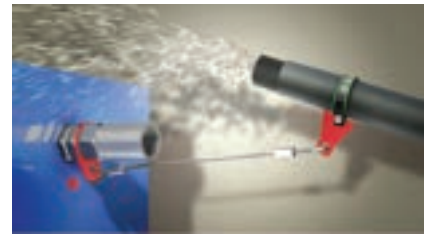

Step 1: Select a WRC part number based on the outside diameter of your hose.

[view on web page](#)

## Hose Collars

Part Number	A		B		Hose Collar Bolt Size*
	inch	mm	inch	mm	
WRC1212	0.47	12,0	0.49	12,5	M6
WRC1313	0.51	13,0	0.53	13,5	M6
WRC1415	0.55	14,0	0.59	15,0	M6
WRC1718	0.67	17,0	0.71	18,0	M6
WRC1819	0.71	18,0	0.75	19,0	M6
WRC2021	0.79	20,0	0.83	21,0	M6
WRC2223	0.87	22,0	0.91	23,0	M6
WRC2425	0.95	24,0	0.98	25,0	M6
WRC2526	0.98	25,0	1.02	26,0	M6
WRC2728	1.06	27,0	1.10	28,0	M6
WRC2829	1.10	28,0	1.14	29,0	M6
WRC3031	1.18	30,0	1.22	31,0	M6
WRC3435	1.34	34,0	1.38	35,0	M6
WRC3637	1.42	36,0	1.46	37,0	M6
WRC3839	1.50	38,0	1.54	39,0	M6
WRC4243	1.65	42,0	1.69	43,0	M6
WRC4445	1.73	44,0	1.77	45,0	M6
WRC4547	1.77	45,0	1.85	47,0	M8
WRC4850	1.89	48,0	1.97	50,0	M8
WRC5153	2.01	51,0	2.09	53,0	M8
WRC5456	2.13	54,0	2.21	56,0	M8
WRC6365	2.48	63,0	2.56	65,0	M8
WRC6971	2.72	69,0	2.78	71,0	M8

\*Bolt size on collar must match the WRA or WRF bolt size.

**WARNING:** This product can expose you to chemicals including Lead, which is known to the State of California to cause cancer and birth defects or other reproductive harm. For more information go to [www.p65warnings.ca.gov](http://www.p65warnings.ca.gov).

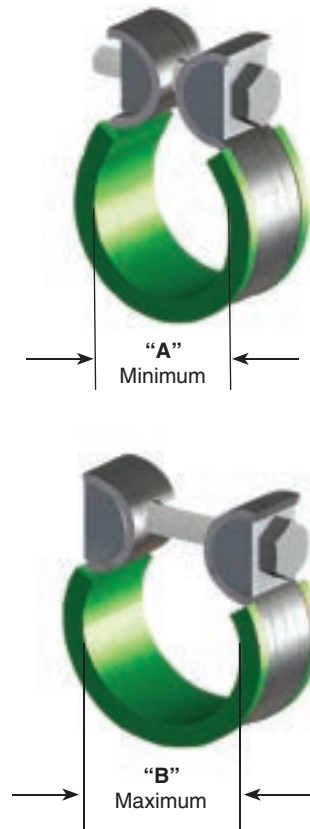

**Step 2:** Select either a WRA or a WRF cable assembly based on your connection type.

**Cable assembly for hose fittings or adapters**

Part Number	Maximum Working Pressure psi	Hole I.D. C		Cable Length D		Grip Plate Bolt Size*
		inch	mm	inch	mm	
WRA115	6525	0.45	11,5	11.81	300	M6
WRA132	6525	0.52	13,2	11.81	300	M6
WRA145	6525	0.57	14,5	11.81	300	M6
WRA148	6525	0.58	14,8	11.81	300	M6
WRA170	6453	0.67	17,0	11.81	300	M6
WRA185	6090	0.73	18,5	11.81	300	M6
WRA195	6090	0.77	19,5	11.81	300	M6
WRA205	6090	0.81	20,5	11.81	300	M6
WRA225	6090	0.89	22,5	11.81	300	M6
WRA228	6090	0.90	22,8	11.81	300	M6
WRA245	6090	0.96	24,5	11.81	300	M6
WRA265	6090	1.04	26,5	11.81	300	M6
WRA275	6090	1.08	27,5	11.81	300	M6
WRA305	6090	1.20	30,5	11.81	300	M6
WRA340S	6090	1.34	34,0	17.72	450	M6
WRA340JIC	6090	1.34	34,0	17.72	450	M8
WRA365	6090	1.44	36,5	17.72	450	M8
WRA415S	6090	1.63	41,5	17.72	450	M6
WRA415	6090	1.63	41,5	17.72	450	M8
WRA425	6090	1.67	42,5	17.72	450	M8
WRA455	6090	1.79	45,5	17.72	450	M8
WRA480S	6090	1.89	48,0	17.72	450	M6
WRA480	6090	1.89	48,0	17.72	450	M8
WRA490	6090	1.93	49,0	17.72	450	M8
WRA525	5583	2.07	52,5	17.72	450	M8
WRA600	5075	2.36	60,0	17.72	450	M8
WRA640	5075	2.52	64,0	17.72	450	M8

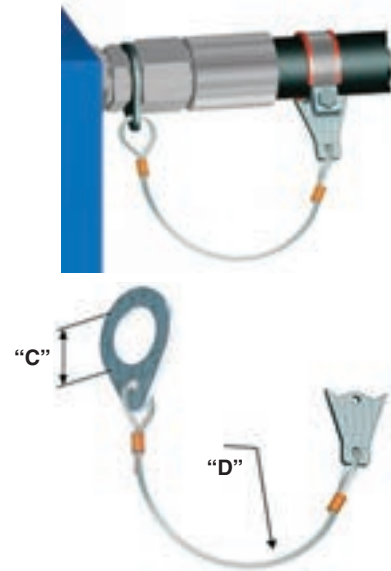

**WARNING:** This product can expose you to chemicals including Lead, which is known to the State of California to cause cancer and birth defects or other reproductive harm. For more information go to [www.p65warnings.ca.gov](http://www.p65warnings.ca.gov).

**Cable assembly for Code 61/Code 62 flanges**

Part Number	Maximum Working Pressure psi	Hole I.D. C		Cable Length D		Grip Plate Bolt Size*
		inch	mm	inch	mm	
WRF085	6018	0.33	8,5	11.81	300	M6
WRF105	6090	0.41	10,5	17.72	450	M8
WRF125	6090	0.49	12,5	17.72	450	M8
WRF145	6090	0.57	14,5	17.72	450	M8
WRF165	6090	0.65	16,5	17.72	450	M8
WRF205	5075	0.81	20,5	17.72	450	M8

\*Bolt size on collar must match the WTA or WRF bolt size.

**WARNING:** This product can expose you to chemicals including Lead, which is known to the State of California to cause cancer and birth defects or other reproductive harm. For more information go to [www.p65warnings.ca.gov](http://www.p65warnings.ca.gov).

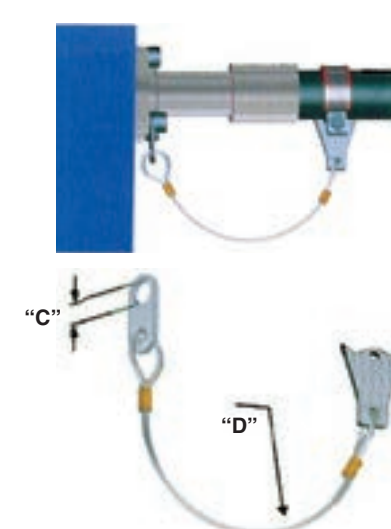

The Hose Whip Restraint System has been tested to the operating pressures of the hoses listed in Hose Products Division Catalog 4400. The Hose Whip Restraint is not designed to increase the hose rated pressure or to add incremental pressure rating to the hose / fitting combination. Your hose / fitting / whip restraint system is rated to the pressure of the lowest rated component of the system.

# Hose Whip Restraint Selection Guide

## Collar

Part Number	Min. Opening A		Max. Opening B		201, 221FR, 206, 225, 244, 266	213, 285, 293	302, 304, 421WC	187/TC/ST 422, 424, 436, 387/TC/ST 471TC/ST, 482TC/ST, 472TC/ST 487/TC/ST	601	722/TC/ST, 774	F42	801, 804, 821, 821FR, 836	811, 881, 811HT	787/TC/ST 797/TC/ST
	inch	mm	inch	mm										
WRC1212	0.47	12,0	0.49	12,5		-4			-3			-4		
WRC1313	0.51	13,0	0.53	13,5	-4		-3	-4						-4
WRC1415	0.55	14,0	0.59	15,0	-5	-5, -6	-4	-5	-4			-5, -6		
WRC1718	0.67	17,0	0.71	18,0	-6			-6	-5					-6
WRC1819	0.71	18,0	0.75	19,0	-8	-8	-6		-6			-8		
WRC2021	0.79	20,0	0.83	21,0				-8		-6				-8
WRC2223	0.87	22,0	0.91	23,0	-10	-10	-8		-8	-8		-10		-10
WRC2425	0.95	24,0	0.98	25,0		-12		-10			-8			
WRC2526	0.98	25,0	1.02	26,0			-10		-10			-12		
WRC2728	1.06	27,0	1.10	28,0	-12			-12		-10				-12
WRC2829	1.10	28,0	1.14	29,0			-12							
WRC3031	1.18	30,0	1.22	31,0	-16	-16			-12	-12	-12	-16	-12	
WRC3435	1.34	34,0	1.38	35,0				-16						-16
WRC3637	1.42	36,0	1.46	37,0		-20			-16	-16			-16	
WRC3839	1.50	38,0	1.54	39,0	-20		-16				-16			
WRC4243	1.65	42,0	1.69	43,0										
WRC4445	1.73	44,0	1.77	45,0	-24	-24			-20				-20	
WRC4547	1.77	45,0	1.85	47,0			-20	-20		-20				-20
WRC4850	1.89	48,0	1.97	50,0				-24			-20			
WRC5153	2.01	51,0	2.09	53,0						-24			-24	-24
WRC5456	2.13	54,0	2.21	56,0	-32	-32	-24							
WRC6365	2.48	63,0	2.56	65,0				-32		-32			-32	
WRC6971	2.72	69,0	2.80	71,0										-32

**WARNING:** This product can expose you to chemicals including Lead, which is known to the State of California to cause cancer and birth defects or other reproductive harm. For more information go to [www.p65warnings.ca.gov](http://www.p65warnings.ca.gov).



# Hose Whip Restraint Selection Guide

## Adapter

Part Number	A		JIC 37° Fittings 103XX, 106XX, 137XX, 1L7XX, 139XX, 1L9XX, 141XX, 14VXX Port End	Seal Lok (O-Ring Face Seal) 1JOXX, 1JBXX, 1JCXX, 1JSXX, 1J6XX, 1J7XX, 1J9XX, 1J5XX, 1J1XX Port End	NPTF / NPSM 101XX, 113XX, 11LXX, 102XX, 1S2XX Port End	BSPP / BSP 1D9XX, 192XX, 1B1XX, 1B2XX, 1B4XX, 1B5XX, 1FUXX, 1UTXX, 1GUXX Port End
	inch	mm				
WRA115	0.45	11,5	-4			
WRA132	0.52	13,2	-5			
WRA145	0.57	14,5		-4	-4	-4
WRA148	0.58	14,8	-6			
WRA170	0.67	17,0				-6
WRA185	0.73	18,5		-6	-6	
WRA195	0.77	19,5				
WRA205	0.81	20,5	-8			
WRA225	0.89	22,5		-8	-8	-8
WRA228	0.90	22,8	-10			
WRA245	0.96	24,5				-10
WRA265	1.04	26,5		-10		
WRA275	1.08	27,5	-12			
WRA305	1.20	30,5	-14	-12	-12	-12
WRA340S	1.34	34,0	-16		-16	-16
WRA340JIC	1.34	34,0	-16			
WRA365	1.44	36,5		-16		
WRA415S	1.63	41,5	-20			
WRA415	1.63	41,5	-20			
WRA425	1.67	42,5			-20	-20
WRA455	1.79	45,5		-20		
WRA480S	1.89	48,0	-24			
WRA480	1.89	48,0	-24			
WRA490	1.93	49,0			-24	-24
WRA525	2.07	52,5		-24		
WRA600	2.36	60,0				
WRA640	2.52	64,0	-32			

Contact HPD for other style fittings.

**WARNING:** This product can expose you to chemicals including Lead, which is known to the State of California to cause cancer and birth defects or other reproductive harm. For more information go to [www.p65warnings.ca.gov](http://www.p65warnings.ca.gov).

## Flange

Part Number	A		5050HK	5151HK	HFHFHK	8FHFHK	M1M1HK	M2M2HK	FFK61	FFK62
	inch	mm								
WRF085	0.33	8,5		-8						
WRF105	0.41	10,5		-12, -16	-12	-12	-8, -12, -16, -20	-8, -12	-12, -16	-12
WRF125	0.49	12,5	-20	-20	-16	-16	-24, -32, -40	-16, -20	-20	-16
WRF145	0.57	14,5	-24, -32	-24, -32, -40	-20				-24, -32	-20
WRF165	0.65	16,5		-48	-24			-24		-24
WRF205	0.81	20,5			-32			-32		-32

**WARNING:** This product can expose you to chemicals including Lead, which is known to the State of California to cause cancer and birth defects or other reproductive harm. For more information go to [www.p65warnings.ca.gov](http://www.p65warnings.ca.gov).



# CL Clamp

Vinyl coated steel clamps provide hose support where long lengths are used. Provides neater installation of hose lines, minimizes hose chafing and prevents damage to hose.

**Material:** CR Steel with Zinc Plating

**Coating:** Black Vinyl Plastisol - 0,8 mm (0.03 inch) thick.

**Temperature Range:** -40°C to +107°C (-40°F to +225°F).



view on web page

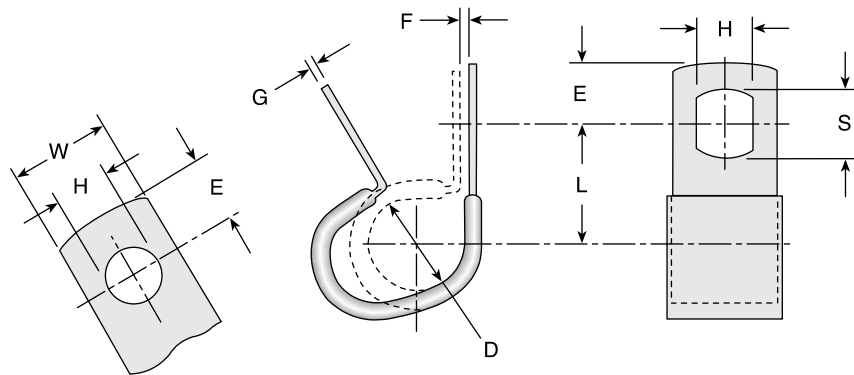

Part Number	D		H		L		W		E		F		G		S	
	±0,8 (mm)	±0.031 (inch)	±0,1 (mm)	±0.005 (inch)	±0,8 (mm)	±0.031 (inch)	±0,25 (mm)	±0.01 (inch)	±0,4 (mm)	±0.015 (inch)	±0,8 (mm)	±0.031 (inch)	±0,1 (mm)	±0.004 (inch)	±0,5 (mm)	±0.020 (inch)
CL-6	7,90	0.312	10,30	0.406	17,45	0.687	19,05	0.750	11,10	0.437	0,80	0.031	0,80	0.032	12,70	0.500
CL-7	9,50	0.375	10,30	0.406	18,25	0.718	19,05	0.750	11,10	0.437	1,55	0.062	0,80	0.032	12,70	0.500
CL-9	12,70	0.500	10,30	0.406	19,85	0.781	19,05	0.750	11,10	0.437	1,55	0.062	1,20	0.048	12,70	0.500
CL-10	14,25	0.562	10,30	0.406	20,60	0.812	19,05	0.750	11,10	0.437	1,55	0.062	1,20	0.048	12,70	0.500
CL-11	15,90	0.625	10,30	0.406	21,40	0.843	19,05	0.750	11,10	0.437	1,55	0.062	1,20	0.048	12,70	0.500
CL-12	17,45	0.687	10,30	0.406	22,20	0.875	19,05	0.750	11,10	0.437	1,55	0.062	1,20	0.048	12,70	0.500
CL-13	19,05	0.750	10,30	0.406	23,00	0.906	19,05	0.750	11,10	0.437	1,55	0.062	1,20	0.048	12,70	0.500
CL-14	20,60	0.812	10,30	0.406	23,80	0.937	19,05	0.750	11,10	0.437	1,55	0.062	1,20	0.048	12,70	0.500
CL-16	23,80	0.937	10,30	0.406	25,40	1.000	19,05	0.750	11,10	0.437	1,55	0.062	1,20	0.048	12,70	0.500
CL-17	25,40	1.000	10,30	0.406	26,20	1.031	19,05	0.750	11,10	0.437	1,55	0.062	1,20	0.048	12,70	0.500
CL-18	26,95	1.062	10,30	0.406	26,95	1.062	19,05	0.750	11,10	0.437	1,55	0.062	1,20	0.048	12,70	0.500
CL-19	28,60	1.125	10,30	0.406	27,75	1.093	19,05	0.750	11,10	0.437	1,55	0.062	1,20	0.048	12,70	0.500
CL-20	30,20	1.188	13,50	0.531	31,75	1.250	25,40	1.000	14,25	0.562	1,55	0.062	1,20	0.048	15,90	0.625
CL-21	31,75	1.250	13,50	0.531	32,55	1.281	25,40	1.000	14,25	0.562	1,55	0.062	1,20	0.048	15,90	0.625
CL-23	34,90	1.375	13,50	0.531	34,10	1.343	25,40	1.000	14,25	0.562	1,55	0.062	1,20	0.048	15,90	0.625
CL-24	36,50	1.437	13,50	0.531	34,90	1.375	25,40	1.000	14,25	0.562	1,55	0.062	1,20	0.048	15,90	0.625
CL-25	38,10	1.500	13,50	0.531	35,70	1.406	25,40	1.000	14,25	0.562	1,55	0.062	1,20	0.048	15,90	0.625
CL-26	39,65	1.562	13,50	0.531	36,50	1.437	25,40	1.000	14,25	0.562	1,55	0.062	1,20	0.048	15,90	0.625
CL-29	44,45	1.750	13,50	0.531	38,90	1.531	25,40	1.000	14,25	0.562	1,55	0.062	1,20	0.048	15,90	0.625
CL-31	47,65	1.875	13,50	0.531	40,45	1.593	25,40	1.000	14,25	0.562	1,55	0.062	1,20	0.048	15,90	0.625
CL-33	50,80	2.000	13,50	0.531	42,85	1.687	25,40	1.000	14,25	0.562	1,55	0.062	1,20	0.048	15,90	0.625
CL-36	55,55	2.187	13,50	0.531	46,00	1.812	25,40	1.000	14,25	0.562	1,55	0.062	1,20	0.048	15,90	0.625
CL-37	57,15	2.250	13,50	0.531	46,00	1.812	25,40	1.000	14,25	0.562	1,55	0.062	1,20	0.048	15,90	0.625
CL-43	66,65	2.625	13,50	0.531	58,70	2.312	25,40	1.000	14,25	0.562	1,55	0.062	1,20	0.048	15,90	0.625

**WARNING:** This product can expose you to chemicals including Carbon Black, which is known to the State of California to cause cancer. For more information go to [www.p65warnings.ca.gov](http://www.p65warnings.ca.gov).

## HC, 88HC-H and 88DB Clamp

The Parker HC Clamp is a stainless steel worm gear clamp designed for low pressure industrial hose applications.

### HC Hose Clamp Table

SAE J1508 Type F

Part Number	Size (SAE)	"A" Clamp Diameter				"B" Maximum	
		Minimum mm	inch	Maximum mm	inch	mm	inch
HC-6	-8	13	0.50	23	0.91	19,1	0.75
HC-8	-10	14	0.56	27	1.06	19,1	0.75
HC-10	-12	18	0.69	32	1.25	19,1	0.75
88HC-12	-16	21	0.81	38	1.50	19,1	0.75
88HC-16	-20	21	0.81	44	1.75	19,1	0.75
88HC-20	-24	27	1.06	51	2.00	19,1	0.75
88HC-24	-28	33	1.31	57	2.25	19,1	0.75
88HC-32	-36	46	1.81	70	2.75	19,1	0.75

Suggested installation torque: 35 in-lbs (4 Nm)

Material: Band & Housing: 201 SS

Screw: 410 SS

Band Width : 0.562 in.

Band Thickness: 0.022 in (0.559 mm)

**WARNING:** This product can expose you to chemicals including Lead, which is known to the State of California to cause cancer and birth defects or other reproductive harm. For more information go to [www.p65warnings.ca.gov](http://www.p65warnings.ca.gov).

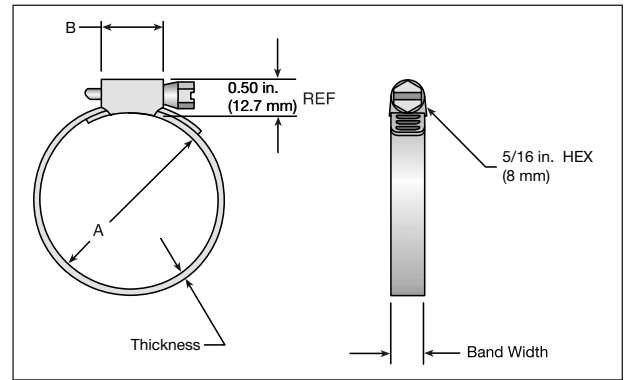

view on web page

### 88HC-H

Series Hose Clamp (High Torque Wormgear)  
SAE J1508 Type HD

Part Number	Size (SAE)	"A" Clamp Diameter				"B" Maximum	
		Minimum mm	inch	Maximum mm	inch	mm	inch
88HC-16H	175	25	1.00	44	1.750	26,9	1.06
88HC-20H	212	32	1.25	54	2.125	26,9	1.06
88HC-32H	262	44	1.75	67	2.625	26,9	1.06
88HC-40H	312	57	2.25	80	3.625	26,9	1.06
88HC-48H	362	70	2.75	92	3.625	26,9	1.06

view on web page

Use for 88 Series Fittings

Suggested installation torque: 75 to 90 in-lbs (8.5 to 10 Nm)

**Note:** See 88 Series Assembly Instructions for proper 88HC-H clamp attachment.

Material: Band & Housing: 304 SS

Screw: 410 SS

Band Width: 0.625 in.

Band Thickness: 0.028 in (0.711 mm)

Use for 88 Series Fittings

Material: Iron

**WARNING:** This product can expose you to chemicals including Lead, which is known to the State of California to cause cancer and birth defects or other reproductive harm. For more information go to [www.p65warnings.ca.gov](http://www.p65warnings.ca.gov).

### 88DB

Series Heavy Duty Hose Clamp  
(Double Bolt Hose Clamp)

Part Number	"A" I.D. inch	"B" Width inch	"C" Width inch
88DB-12	1.25	0.88	1.75
88DB-16	1.40	0.75	2.00
88DB-20	1.75	0.96	2.35
88DB-24	2.00	1.00	2.66
88DB-32	2.40	1.03	3.12

view on web page

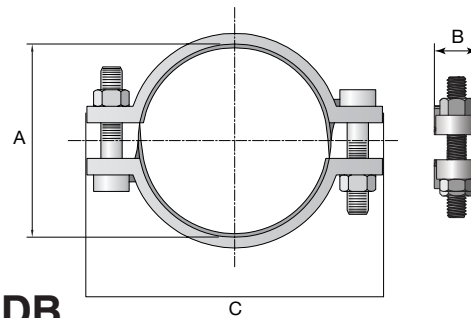

# HPD Hose Assembly Workstations

Hose Products Division has set up an agreement to enable our customers to purchase directly from our vendor, Safety Step.



<b>Safety Step's contact information is:</b>	Safety Step 540-362-9636 <a href="http://www.safetystep.net">www.safetystep.net</a>
--	---

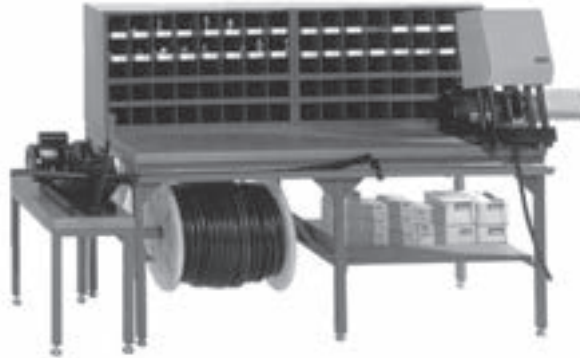

The complete on-site complete hose assembly workstation design (above) includes:

- TH7-5-C—6' table with 1 hose reel and 1 bottom shelf
- TH7-6—16 hose reel system, with rotating base
- TH7-7—15" wide table set up for Parker 239 or 339 Cut-Off Saw

- (2) 40B-Cabinet 40 openings - 4-1/2" x 4-1/2" x 12" in size
- TH7-6-C—Optional overhead crane
- TH7-5-HT—Optional 6' measured hose trough with adjustable hose stop

**Specifications: HoseFab Table (heavy duty)**

- Laminated wood table top
- 1-1/2" square tubing structure
- Gussetted corner braces
- 6-leg design
- All legs have adjustable feet
- Hose reel/shelf combinations
- 40B-Cabinet or 72B-Cabinet for fitting storage
- *Optional: Hose trough for measurement of hose*
  - Calibrated to line up to Saw Table
  - Adjustable stop for standard length cuts
  - Built-in tape measure

**Specifications: Rotary Reel Rack (TH7-6)**

- 16 Hose reel capacity
- Compact design
- Rotates for 1 man use
- Center post bolts to floor in 4 places
- Optional: Overhead crane

**Specifications: Saw Table (TH7-7)**

- Calibrated to line up to Hose trough
- Adjustable feet

**Specifications: 3 or 4 Reel Rack**

- Free standing 3 reel rack (TH7-8)
- Bolts to floor
- Optional: 4th reel capacity with wall mounts (TH7-8-F)



Pictured left is a complete on-site hose assembly workstation, the Parker Kart:

The **Parker Kart, TH7-4**, is a portable all-in-one unit designed to hold a Minikrimp, Karrykrimp, Karrykrimp 2, or Parkrimp 1; a 332T-115V Cut-off Saw; 4 reels of hose; and has a 40 bin cabinet with 3 drawers for tools. The TH7-4 can be customized to fit your specific hose assembly needs. Contact Parker HPD or your Parker Hose distributor for details.

**Note:** Part number TH7-4 does not include hose, fittings or equipment.

See Safety Step contact information at the top of this page

**Note:** Part number and specifications of components for both workstations are listed on the following pages.



## HoseFab Table

Heavy duty constructed table for mounting Minikrimp, Karrykrimp, Karrykrimp 2, or Parkrimp 1. HoseFab Table is available in 3 versions to meet your requirements. Options include two 40B-Cabinets or 72B-Cabinets for fitting storage.

Part Number	Description
TH7-5-R	6' table with 2 hose reels
TH7-5-S	6' table with 2 bottom shelves
TH7-5-C	6' table with 1 hose reel and 1 bottom shelf
TH7-5-HT	Optional 6' measured hose trough with adjustable hose stop
40B-Cabinet	40 openings - 4-1/2" x 4-1/2" x 12" in size
72B-Cabinet	72 openings - 4-1/2" x 4-1/2" x 12" in size

**Table measurements:**

Height - 31-3/4"  
 Width - 29"  
 Length - 72"

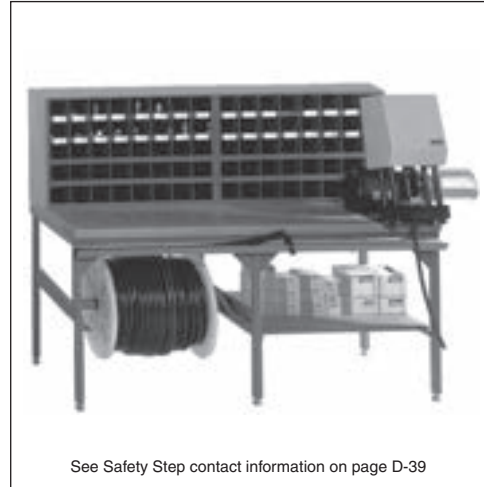

See Safety Step contact information on page D-39

## Rotary Reel Rack

16 Hose reel capacity that fits in a compact area. Supplied with heavy duty casters which allow for ease of turning, even when fully loaded. Optional overhead crane available.

Part Number	Description
TH7-6	16 hose reel system, with rotating base
TH7-6-C	Optional overhead crane

**Rack measurements:**

Height - 104" (120" with optional overhead crane)  
 Width - 67"  
 Length - 67"

[view on web page](#)



See Safety Step contact information on page D-39

## Saw Table

The Saw Table, specially designed for Parker 239 or 339 Hose Cut-Off Saw, attaches directly to the HoseFab Table.

Part Number	Description
TH7-7	15" wide table set up for Parker 239 or 339 Cut-Off Saw

**Table measurements:**

Height - 18"  
 Width - 28"  
 Length - 14"



See Safety Step contact information on page D-39

## 3/4 Reel Rack

Compact in its design, the standard version will hold 3 reels of hose. Optional 4th reel capacity designed with wall anchor mounts.

Part Number	Description
TH7-8	Upright 3 hose reel rack
TH7-8-F	Optional extension with wall anchor for 4th reel

**Rack measurements:**

Height - 59" (82-1/2" with 4th reel option)  
 Width - 27-3/4"  
 Length - 27-1/2"

[view on web page](#)



See Safety Step contact information on page D-39

A

B

C

D

E



## Parker Kart TH7-4

Parker Kart organizes and stores all your necessary Parker hoses, fittings, power and hand tools - everything you need to make fast hose assemblies on site. As a valued addition to any facility, Parker Kart will save on downtime and labor costs, as well as eliminate errors in cutting and fitting attachment. With Parker Kart, you'll always have the materials you need, right when and where you need them.

- Easy one-man movement
- Eight-inch urethane casters with brakes
- Forklift carry tubes
- Electric receptacle with cord
- Fitting bins and drawers
- Large tool drawer
- Four hose reel holders
- Choice of Parker crimping equipment
- Optional accessories available

Parker Kart can be customized to fit specific hose assembly needs. Parker Kart does not include hose, fittings or equipment.



## Fitting Stock Bins 72B-Cabinet

36" wide, 43" high, 12" deep, with 72 openings each 4-1/2" x 4-1/2" x 12", heavy duty steel, all welded construction. Product bin labels are available.

[view on web page](#)



## Hose Stock Bins HR6-Hose-Bin

Rugged metal cabinet for stocking coils of Parker hose 36" wide, 28" high, 20" deep, with upright separators to provide 6 compartments varying in width from 4" to 8".

Provides suitable base on which to place the fittings stock bin (top measures 36" x 20", bottom of fittings bin measures 36" x 12".)

[view on web page](#)

# S T A M P

SIZE

TEMPERATURE

APPLICATION

MEDIA

PRESSURE

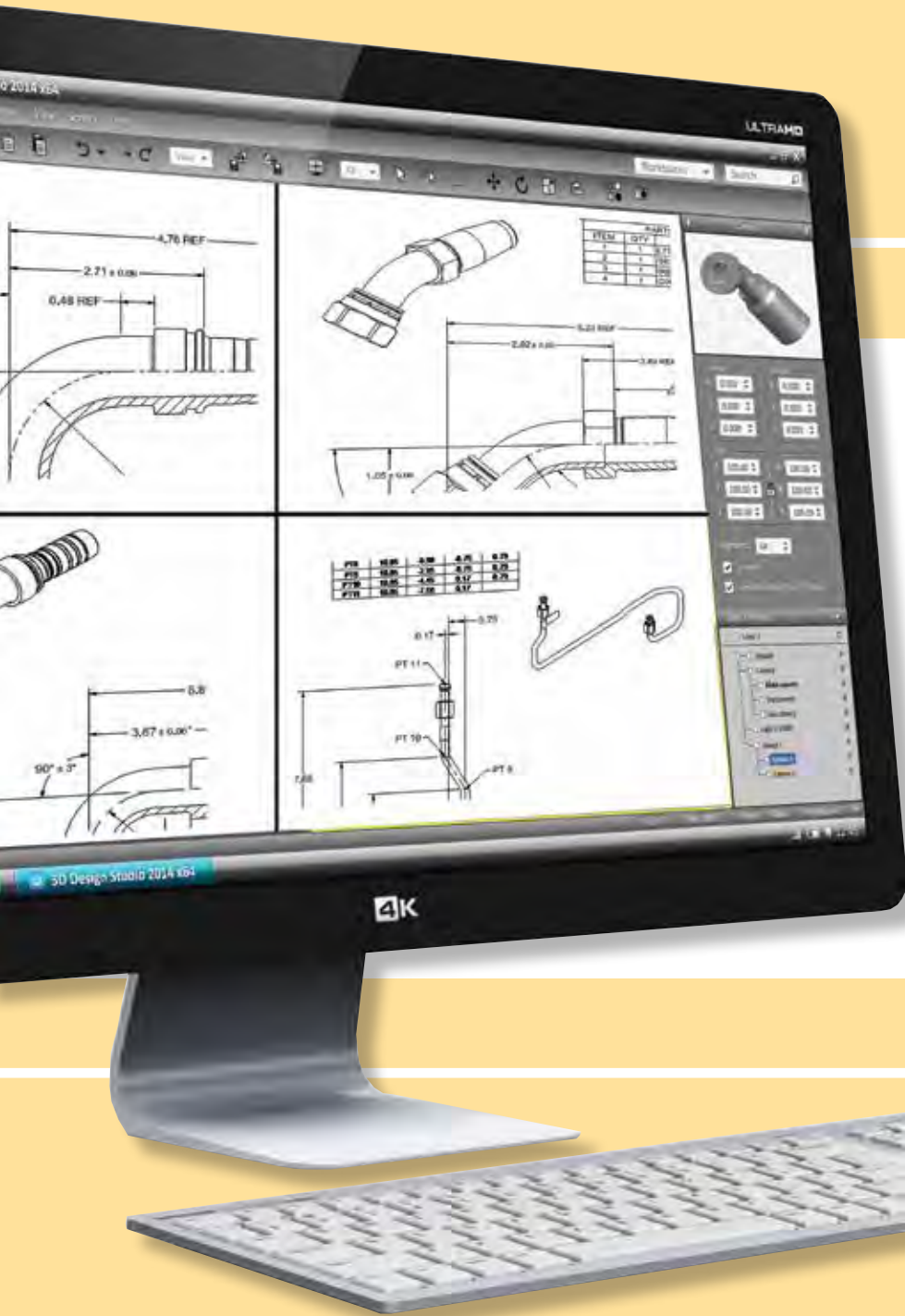

Half SAE Bend



Tough Cover



SuperTough Cover



High Temperature



Low Temperature



Compact

# Technical

Flow Temperature Pressure Installation Chemical Resistance  
Performance Standards & Specifications Fitting Identification  
Safety Guide

## Table of Contents

### Size

Flow Capacities at Recommended Flow Velocities .....	E-3
Hose Flow Capacities Pressure Drop.....	E-4

### Temperature

Temperature/Pressure Chart - 201, 206, 213, and 266 Hose.....	E-5
Minimum/ Maximum Temperature Chart .....	E-6

### Application

Hose Installation Tips .....	E-10
Ferrule-Fix .....	E-13
Performance Standards and Specifications .....	E-14
Assembly Methods .....	E-19
Identifying Fitting Types.....	E-20
Replacing Caterpillar® Flange Fittings .....	E-29
Thread Guide.....	E-31
Standard Fitting Connections by Connection Type .....	E-32
Standard Fitting Connections by End Code .....	E-34
Metric Conversion.....	E-36

### Media

Chemical Resistance Information.....	E-37
--------------------------------------	------

### Pressure

Pressure Rating of Hose End Connections.....	E-47
Metric Pressure Conversions .....	E-48
PSI and MPa or N/mm <sup>2</sup> Conversions.....	E-49

Part Number Index .....	E-50
Fitting Size Identification Chart.....	E-56

Safety Guide & MSDS Statement.....	E-58
Offer of Sale .....	E-62



# Size

# Flow Capacities at Recommended Flow Velocities

The nomogram below is provided as an aid in determining the correct hose size.

How to use the nomogram: Determine the proper flow rate your system requires, then connect a straight edge from the selected flow rate to the recommended velocity range. The required hose I.D. will appear at the intersection of the straight edge and the center column. If the straight edge passes through the scale between sizes listed, use the next larger I.D. hose.

Example: Locate 16 gallons per minute in the left-hand column and 20 feet per second (fps) in the right-hand column (the maximum

recommended velocity range for pressure lines). Lay a straight edge across these two points. The inside diameter required is shown in the center column at or above the straight edge. In this case, we need a hose I.D. of 0.625 (5/8") inch (or larger).

Use the same procedure for suction or return lines, except utilizing their respective maximum recommended velocities.

Flow  
Gallons per Minute

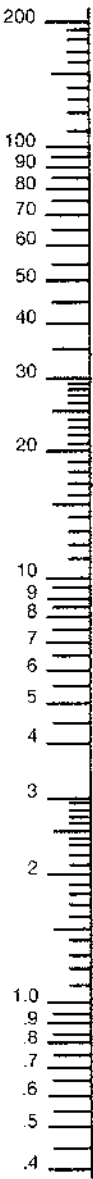

**The nomogram is based on the following formula:**

$$D = \sqrt{\frac{Q \times 0.4081}{V}}$$

Where: Q = Flow in Gallons per Minute (gpm)  
 V = Velocity in Feet per Second (ft/sec)  
 D = Hose Inside Diameter (inches)

**Inside Diameter of Hose**  
**inch / Dash Size**  
 20, 21, 22, 23, All Others  
 Group XV, 90, 91

2-3/8"	40	32	2"
1-13/16"	32	24	1-1/2"
1-3/8"	24	20	1-1/4"
1-1/8"	20	16	1"
7/8"	16	12	3/4"
5/8"	12	10	5/8"
1/2"	10	8	1/2"
13/32"	8	6	3/8"
5/16"	6	5	5/16"
1/4"	5	4	1/4"
3/16"	4	3	3/16"

**Velocity**  
**Feet per Second**

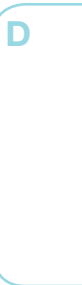
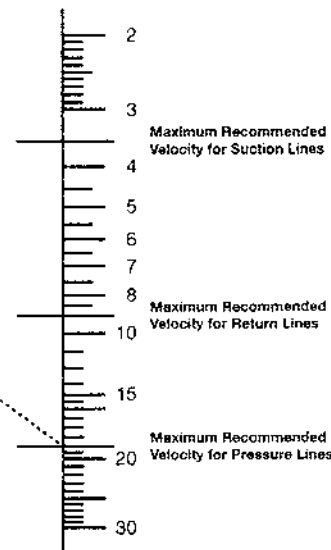

Size

Hose Flow Capacities  
Pressure Drop

Hose Dash Size		-04		-05		-06		-08		-10		-12		-16		-20		-24		-32		-40		-48	
Hose I.D. (Inches)		0.19	0.25	0.25	0.31	0.31	0.38	0.41	0.50	0.50	0.63	0.63	0.75	0.88	1.00	1.13	1.25	1.38	1.50	1.81	2.00	2.38	3.00		
U.S. Gallons per Minute	0.25	10.0	3.1	3.1																					
	0.5	19.0	6.0	6.0	2.7	2.7																			
	1	40.0	12.0	12.0	5.5	5.5	2.4																		
	2	95.0	24.0	24.0	10.0	10.0	4.8	3.5																	
	3	185.0	46.0	46.0	17.0	17.0	7.0	5.0	2.2	2.2															
	4		78.0	78.0	29.0	29.0	12.0	8.0	3.0	3.0	1.2	1.2													
	5		120.0	120.0	44.0	44.0	18.0	12.0	4.5	4.5	1.6	1.6	0.7												
	8				95.0	95.0	39.0	26.0	10.0	10.0	3.6	3.6	1.4	0.6											
	10						59.0	40.0	15.0	15.0	5.7	5.7	2.0	1.0	0.6										
	12						80.0	52.0	20.0	20.0	7.2	7.2	2.6	1.5	0.8	0.4									
	15							75.0	30.0	30.0	10.0	10.0	4.2	2.2	1.2	0.7	0.4								
	18							107.0	40.0	40.0	15.0	15.0	6.3	3.0	1.5	0.7	0.6	0.4							
	20								49.0	49.0	19.0	19.0	8.0	3.4	2.0	1.1	0.7	0.4	0.3						
	25								72.0	72.0	26.0	26.0	11.0	5.5	3.0	1.6	1.0	0.6	0.4	0.2					
	30										34.0	34.0	14.0	7.0	3.6	2.2	1.3	0.8	0.5	0.2	0.1				
	35										47.0	47.0	19.0	9.5	5.0	2.8	1.7	1.1	0.7	0.3	0.2				
	40												25.0	12.0	6.5	3.4	2.2	1.4	0.9	0.4	0.2				
	50												36.0	17.0	9.0	5.3	3.3	2.0	1.3	0.5	0.4	0.2			
	60												50.0	23.0	12.0	7.5	4.4	2.8	1.8	0.8	0.5	0.2			
	70													31.0	17.0	9.3	6.0	3.8	2.4	1.0	0.7	0.3			
	80													38.0	21.0	12.0	7.1	4.6	3.0	1.2	0.8	0.3	0.1		
	90													49.0	27.0	15.0	9.0	5.9	3.8	1.5	1.0	0.5	0.1		
	100														33.0	19.0	12.0	7.0	4.7	1.9	1.3	0.6	0.2		
	150														60.0	36.0	22.0	13.0	8.5	3.4	2.2	1.0	0.3		
	200																36.0	23.0	15.0	6.0	3.9	1.7	0.6		
250																54.0	33.0	22.0	8.5	5.3	2.5	0.8			
300																	45.0	29.0	12.0	7.5	4.0	1.1			
400																		51.0	21.0	14.0	6.5	2.2			
500																			32.0	20.0	10.0	3.0			
800																					18.0	5.0			
1000																							10.0		

Pressure drop in psi (pounds per square inch) per 10 feet of hose (smooth bore) without fittings.

Fluid specification: Specific gravity = 0.85; Viscosity =  $\nu$  = 20 centistokes (C.S.), (20 C.S. = 97 S.S.U.)

Pressure drop values listed are typical of many petroleum based hydraulic oils at approximately +100°F (+38°C). Differences in fluids, fluid temperature and viscosity can increase or decrease actual pressure drop compared to the values listed.

# Temperature

## Temperature / Pressure Chart - 201, 206, 213, and 266 Hose

The Temperature / Pressure Chart identifies the effects temperature change has on the maximum working pressure of specific hoses.

**How to use the chart:**

- 1st** - Identify the Maximum Working Pressure of selected hose.
- 2nd** - Identify the maximum working temperature of the application.
- 3rd** - Locate point where temperature and Percent of Maximum Working Pressure intersect on the chart.
- 4th** - Based on percentage figure, calculate Maximum Working Pressure of the application.

**Example:** 201-8 hose to be used a 250°F (121°C)

Maximum Working Pressure up to 212°F (100°C)	x	(Multiplier from chart)	=	Maximum Working Pressure at 250°F (121°C)
2,000 psi	x	(85%)	=	1,700 psi

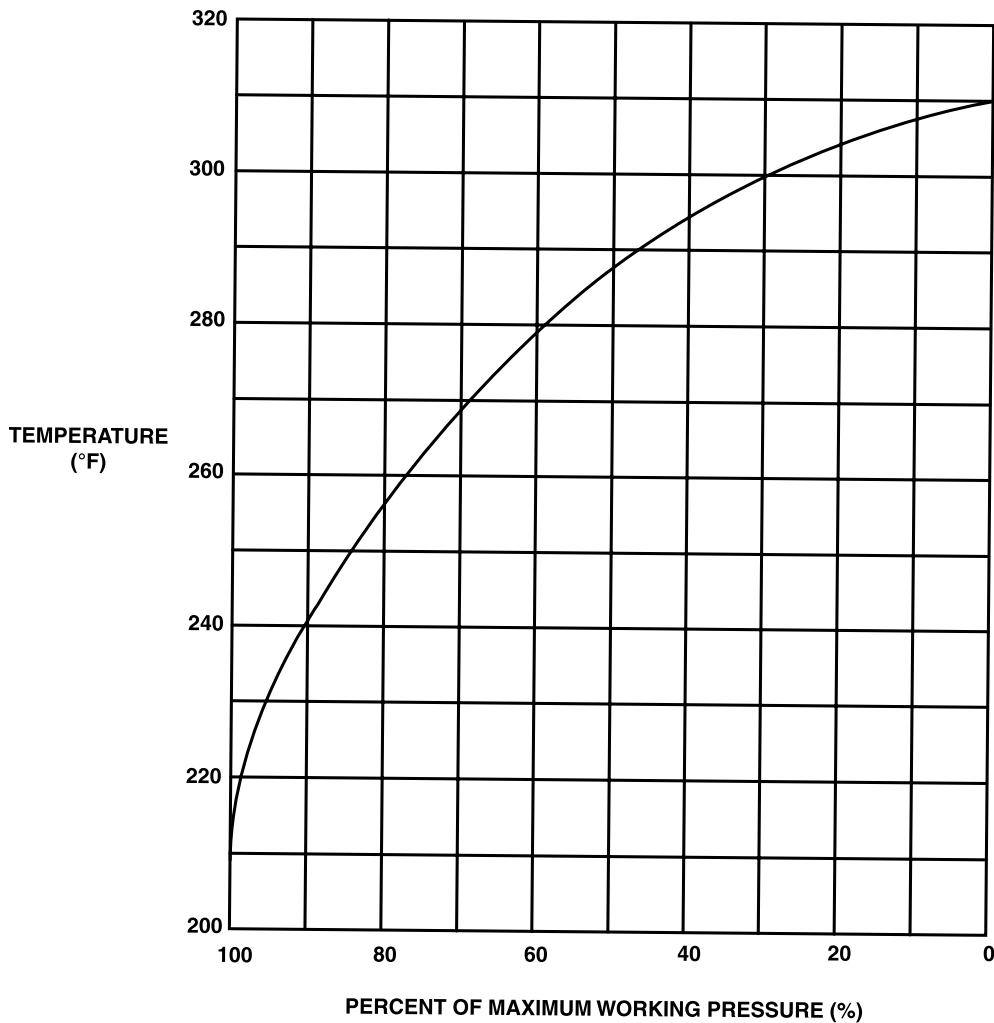

# Temperature

# Minimum/Maximum Temperature

(Page 1 of 4)

Hose Family	Cover (ISO Rating)	Petroleum base hydraulic fluids and lubricating oils	Antifreeze solutions	Diesel fuels	SAE J1942 Marine lube oil and diesel fuel systems (Application Code F)**
GlobalCore 187	Standard	-40°C to +100°C (-40°F to +212°F)	-40°C to +100°C (-40°F to +212°F)	x	x
	TC (AC)	-40°C to +125°C (-40°F to +257°F)	-40°C to +125°C (-40°F to +257°F)	x	x
	TC (AS)	-40°C to +100°C (-40°F to +212°F)	-40°C to +100°C (-40°F to +212°F)	x	x
	ST (AC)	-40°C to +125°C (-40°F to +257°F)	-40°C to +125°C (-40°F to +257°F)	x	x
	ST (AS)	-40°C to +100°C (-40°F to +212°F)	-40°C to +100°C (-40°F to +212°F)	x	x
GlobalCore 387	Standard	-40°C to +100°C (-40°F to +212°F)	-40°C to +100°C (-40°F to +212°F)	x	x
	TC	-40°C to +125°C (-40°F to +257°F)	-40°C to +125°C (-40°F to +257°F)	x	x
	ST	-40°C to +125°C (-40°F to +257°F)	-40°C to +125°C (-40°F to +257°F)	x	x
GlobalCore 487	Standard	-40°C to +100°C (-40°F to +212°F)	-40°C to +100°C (-40°F to +212°F)	x	x
	TC	-40°C to +125°C (-40°F to +257°F)	-40°C to +125°C (-40°F to +257°F)	x	x
	ST	-40°C to +125°C (-40°F to +257°F)	-40°C to +125°C (-40°F to +257°F)	x	x
GlobalCore 722	Standard	-40°C to +100°C (-40°F to +212°F)	-40°C to +100°C (-40°F to +212°F)	x	x
	TC	-40°C to +125°C (-40°F to +257°F)	-40°C to +125°C (-40°F to +257°F)	x	x
	ST	-40°C to +125°C (-40°F to +257°F)	-40°C to +125°C (-40°F to +257°F)	x	x
GlobalCore 787	Standard	-40°C to +100°C (-40°F to +212°F)	-40°C to +100°C (-40°F to +212°F)	x	x
	TC (DC)	-40°C to +125°C (-40°F to +257°F)	-40°C to +125°C (-40°F to +257°F)	x	x
	TC (AC)	-40°C to +100°C (-40°F to +212°F)	-40°C to +100°C (-40°F to +212°F)	x	x
	ST (DC)	-40°C to +125°C (-40°F to +257°F)	-40°C to +125°C (-40°F to +257°F)	x	x
	ST (AC)	-40°C to +100°C (-40°F to +212°F)	-40°C to +100°C (-40°F to +212°F)	x	x
GlobalCore 797	Standard	-40°C to +100°C (-40°F to +212°F)	-40°C to +100°C (-40°F to +212°F)	x	x
	TC (CC, DC)	-40°C to +125°C (-40°F to +257°F)	-40°C to +125°C (-40°F to +257°F)	x	x
	TC (AC)	-40°C to +100°C (-40°F to +212°F)	-40°C to +100°C (-40°F to +212°F)	x	x
	ST (CC, DC)	-40°C to +125°C (-40°F to +257°F)	-40°C to +125°C (-40°F to +257°F)	x	x
	ST (AC)	-40°C to +100°C (-40°F to +212°F)	-40°C to +100°C (-40°F to +212°F)	x	x
201*		-40°C to +150°C (-40°F to +302°F)	-40°C to +150°C (-40°F to +302°F)	-40°C to +150°C (-40°F to +302°F)	x
206*		-48°C to +150°C (-55°F to +302°F)	-48°C to +150°C (-55°F to +302°F)	-48°C to +150°C (-55°F to +302°F)	x
213*		-45°C to +150°C (-50°F to +302°F)	-45°C to +150°C (-50°F to +302°F)	-45°C to +150°C (-50°F to +302°F)	x
221FR		-20°C to +100°C (-4°F to +212°F)	x	-20°C to +100°C (-4°F to +212°F)	-20°C to +100°C (-4°F to +212°F)
266*		-48°C to +150°C (-55°F to +302°F)	-48°C to +150°C (-55°F to +302°F)	-48°C to +150°C (-55°F to +302°F)	x
271		x	x	x	x
293		-50°C to +150°C (-58°F to +302°F)	-50°C to +150°C (-58°F to +302°F)	-50°C to +150°C (-58°F to +302°F)	x
302		-40°C to +100°C (-40°F to +212°F)	x	x	-40°C to +100°C (-40°F to +212°F)
304		x	x	x	x
422		-40°C to +100°C (-40°F to +212°F)	x	x	-40°C to +100°C (-40°F to +212°F)
424		x	x	x	x
426		-46°C to +150°C (-50°F to +302°F)	x	x	-46°C to +150°C (-50°F to +302°F)
436		-48°C to +150°C (-55°F to +302°F)	x	x	x
471TC/ST		-40°C to +100°C (-40°F to +212°F)	x	x	x
472LT		-57°C to +100°C (-70°F to +212°F)	x	x	x
472TC		-40°C to +100°C (-40°F to +212°F)	x	x	x
482TC/ST		-40°C to +100°C (-40°F to +212°F)	x	x	x
611HT		-48°C to +150°C (-55°F to +302°F)	-45°C to +150°C (-55°F to +302°F)	-45°C to +150°C (-55°F to +302°F)	x

\* The maximum working pressures for these hoses are reduced at temperatures above +212°F (+100°C). Consult the pressure/temperature curve on E-5 for the reduced maximum working pressure.

\*\* Maximum service pressure for lube oil and fuel systems applications (Code F) may be less than maximum service pressure for other systems applications, e.g., Code H. Refer to individual hose listings in Section A and Hose Assemblies List, SAE J1942-1 or HPD Approval Bulletin #APR-004.

# Temperature

# Minimum/Maximum Temperature

(Page 2 of 4)

Hose	Cover (ISO Rating)	Air	Water, water/oil emulsion	Water/glycol hydraulic	Water	Phosphate ester fluids	Polyol ester fluids
GlobalCore 187	Standard	+70°C (+158°F)	+85°C (+185°F)	+85°C (+185°F)	+85°C (+185°F)	x	x
	TC (AC)	+70°C (+158°F)	+85°C (+185°F)	+85°C (+185°F)	+85°C (+185°F)	x	x
	TC (AS)	+70°C (+158°F)	+85°C (+185°F)	+85°C (+185°F)	+85°C (+185°F)	x	x
	ST (AC)	+70°C (+158°F)	+85°C (+185°F)	+85°C (+185°F)	+85°C (+185°F)	x	x
	ST (AS)	+70°C (+158°F)	+85°C (+185°F)	+85°C (+185°F)	+85°C (+185°F)	x	x
GlobalCore 387	Standard	+70°C (+158°F)	+85°C (+185°F)	+85°C (+185°F)	+85°C (+185°F)	x	x
	TC	+70°C (+158°F)	+85°C (+185°F)	+85°C (+185°F)	+85°C (+185°F)	x	+65°C (+150°F)
	ST	+70°C (+158°F)	+85°C (+185°F)	+85°C (+185°F)	+85°C (+185°F)	x	+65°C (+150°F)
GlobalCore 487	Standard	+70°C (+158°F)	+85°C (+185°F)	+85°C (+185°F)	+85°C (+185°F)	x	x
	TC	+70°C (+158°F)	+85°C (+185°F)	+85°C (+185°F)	+85°C (+185°F)	x	+65°C (+150°F)
	ST	+70°C (+158°F)	+85°C (+185°F)	+85°C (+185°F)	+85°C (+185°F)	x	+65°C (+150°F)
GlobalCore 722	Standard	+70°C (+158°F)	+85°C (+185°F)	+85°C (+185°F)	+85°C (+185°F)	x	+65°C (+150°F)
	TC	+70°C (+158°F)	+85°C (+185°F)	+85°C (+185°F)	+85°C (+185°F)	x	+65°C (+150°F)
	ST	+70°C (+158°F)	+85°C (+185°F)	+85°C (+185°F)	+85°C (+185°F)	x	+65°C (+150°F)
GlobalCore 787	Standard	+70°C (+158°F)	+85°C (+185°F)	+85°C (+185°F)	+85°C (+185°F)	x	+65°C (+150°F)
	TC (DC)	+70°C (+158°F)	+85°C (+185°F)	+85°C (+185°F)	+85°C (+185°F)	x	+65°C (+150°F)
	TC (AC)	+70°C (+158°F)	+85°C (+185°F)	+85°C (+185°F)	+85°C (+185°F)	x	+65°C (+150°F)
	ST (DC)	+70°C (+158°F)	+85°C (+185°F)	+85°C (+185°F)	+85°C (+185°F)	x	+65°C (+150°F)
	ST (AC)	+70°C (+158°F)	+85°C (+185°F)	+85°C (+185°F)	+85°C (+185°F)	x	+65°C (+150°F)
GlobalCore 797	Standard	+70°C (+158°F)	+85°C (+185°F)	+85°C (+185°F)	+85°C (+185°F)	x	+65°C (+150°F)
	TC (CC, DC)	+70°C (+158°F)	+85°C (+185°F)	+85°C (+185°F)	+85°C (+185°F)	x	+65°C (+150°F)
	TC (AC)	+70°C (+158°F)	+85°C (+185°F)	+85°C (+185°F)	+85°C (+185°F)	x	+65°C (+150°F)
	ST (CC, DC)	+70°C (+158°F)	+85°C (+185°F)	+85°C (+185°F)	+85°C (+185°F)	x	+65°C (+150°F)
	ST (AC)	+70°C (+158°F)	+85°C (+185°F)	+85°C (+185°F)	+85°C (+185°F)	x	+65°C (+150°F)
201*		+70°C (+158°F)	+85°C (+185°F)	+85°C (+185°F)	+85°C (+185°F)	x	x
206*		+100°C (+212°F)	+85°C (+185°F)	+85°C (+185°F)	+85°C (+185°F)	x	x
213*		+93°C (+200°F)	+85°C (+185°F)	+85°C (+185°F)	+85°C (+185°F)	x	x
221FR		+70°C (+158°F)	+85°C (+185°F)	+85°C (+185°F)	+85°C (+185°F)	x	x
266*		+93°C (+200°F)	+85°C (+185°F)	+85°C (+185°F)	+85°C (+185°F)	x	x
271		100°C (212°F)	x	x	x	x	x
293		+93°C (+200°F)	+85°C (+185°F)	+85°C (+185°F)	+85°C (+185°F)	x	x
302		+70°C (+158°F)	+85°C (+185°F)	+85°C (+185°F)	+85°C (+185°F)	x	x
304		+70°C (+158°F)	x	+85°C (+185°F)	+85°C (+185°F)	-40°C to +80°C (-40°F to +176°F)	x
422		+70°C (+158°F)	+85°C (+185°F)	+85°C (+185°F)	+85°C (+185°F)	x	x
424		+70°C (+158°F)	x	+85°C (+185°F)	+85°C (+185°F)	-40°C to +80°C (-40°F to +176°F)	x
426		+70°C (+158°F)	+85°C (+185°F)	+85°C (+185°F)	+85°C (+185°F)	x	x
436		+70°C (+158°F)	+85°C (+185°F)	+85°C (+185°F)	+85°C (+185°F)	x	x
471TC/ST		+70°C (+158°F)	+85°C (+185°F)	+85°C (+185°F)	+85°C (+185°F)	x	x
472LT		+70°C (+157°F)	+85°C (+185°F)	+85°C (+185°F)	+85°C (+185°F)	x	
472TC		+70°C (+158°F)	+85°C (+185°F)	+85°C (+185°F)	+85°C (+185°F)	x	+65°C (+150°F)
482TC/ST		+70°C (+158°F)	+85°C (+185°F)	+85°C (+185°F)	+85°C (+185°F)	x	+65°C (+150°F)
611HT		+100°C (+212°F)	+85°C (+185°F)	+85°C (+185°F)	+85°C (+185°F)	x	x

\* The maximum working pressures for these hoses are reduced at temperatures above +212°F (+100°C). Consult the pressure/temperature curve on E-5 for the reduced maximum working pressure.

\*\* Maximum service pressure for lube oil and fuel systems applications (Code F) may be less than maximum service pressure for other systems applications, e.g., Code H. Refer to individual hose listings in Section A and Hose Assemblies List, SAE J1942/1 or HPD Approval Bulletin #APR-004.



# Temperature

# Minimum/Maximum Temperature

(Page 3 of 4)

Hose Family	Cover (ISO Rating)	Petroleum base hydraulic fluids and lubricating oils	Antifreeze solutions	Diesel fuels	SAE J1942 Marine lube oil and diesel fuel systems (Application Code F)**
722LT		-57°C to +100°C (-70°F to +212°F)	x	x	x
792LT		-57°C to +100°C (-70°F to +212°F)	x	x	x
F42		x	x	x	x
774		x	x	x	x
781		-40°C to +125°C (-40°F to +257°F)	x	x	x
801		-40°C to +100°C (-40°F to +212°F)	-40°C to +100°C (-40°F to +212°F)	x	x
804		x	x	x	x
811		-40°C to +100°C (-40°F to +212°F)	x	x	x
821		-40°C to +100°C (-40°F to +212°F)	-40°C to +100°C (-40°F to +212°F)	x	x
821FR		-40°C to +100°C (-40°F to +212°F)	-40°C to +100°C (-40°F to +212°F)	x	x
836		-48°C to +150°C (-55°F to +302°F)	-48°C to +150°C (-55°F to +302°F)	x	x
881		-40°C to +125°C (-40°F to +257°F)	x	x	x
JK		-40°C to +49°C (-40°F to +120°F)	x	x	x
SS23CG		x	x	x	x
SS25UL		x	x	x	x
811HT		-46°C to +125°C (-50°F to +257°F)	x	x	x

\* The maximum working pressures for these hoses are reduced at temperatures above +212°F (+100°C). Consult the pressure/temperature curve on E-5 for the reduced maximum working pressure.

\*\* Maximum service pressure for lube oil and fuel systems applications (Code F) may be less than maximum service pressure for other systems applications, e.g., Code H. Refer to individual hose listings in Section A and Hose Assemblies List, SAE J1942/1 or HPD Approval Bulletin #APR-004.

# Temperature

## Minimum/Maximum Temperature (Page 4 of 4)

Hose	Cover (ISO Rating)	Air	Water, water/oil emulsion	Water/glycol hydraulic	Water	Phosphate ester fluids	Polyol ester fluids
722LT		x	x	x	x	x	x
792LT		+70°C (+158°F)	x	x	x	x	x
F42		+70°C (+158°F)	x	x	x	x	x
774		+70°C (+158°F)	x	+85°C (+185°F)	+85°C (+185°F)	-40°C to +80°C (-40°F to +176°F)	x
781		+70°C (+158°F)	+85°C (+185°F)	+85°C (+185°F)	+85°C (+185°F)	x	x
801		+70°C (+158°F)	+85°C (+185°F)	+85°C (+185°F)	+85°C (+185°F)	x	x
804		+70°C (+158°F)	x	+93°C (+200°F)	+93°C (+200°F)	+80°C (+176°F)	x
811		+70°C (+158°F)	+85°C (+185°F)	+85°C (+185°F)	+85°C (+185°F)	x	x
821		+70°C (+158°F)	+85°C (+185°F)	+85°C (+185°F)	+85°C (+185°F)	x	x
821FR		+100°C (+212°F)	+85°C (+185°F)	+85°C (+185°F)	+85°C (+185°F)	x	x
836		+100°C (+212°F)	+85°C (+185°F)	+85°C (+185°F)	+85°C (+185°F)	x	x
881		+70°C (+158°F)	+85°C (+185°F)	+85°C (+185°F)	+85°C (+185°F)	x	x
JK		x	x	x	x	x	x
SS23CG		x	x	x	x	x	x
SS25UL		x	x	x	x	x	x
811HT		+70°C (+158°F)	+85°C (+185°F)	+85°C (+185°F)	+85°C (+185°F)	x	x

A

B

C

D

E

\* The maximum working pressures for these hoses are reduced at temperatures above +212°F (+100°C). Consult the pressure/temperature curve on E-5 for the reduced maximum working pressure.

\*\* Maximum service pressure for lube oil and fuel systems applications (Code F) may be less than maximum service pressure for other systems applications, e.g., Code H. Refer to individual hose listings in Section A and Hose Assemblies List, SAE J1942/1 or HPD Approval Bulletin #APR-004.

# Application

# Hose Installation Tips

wrong

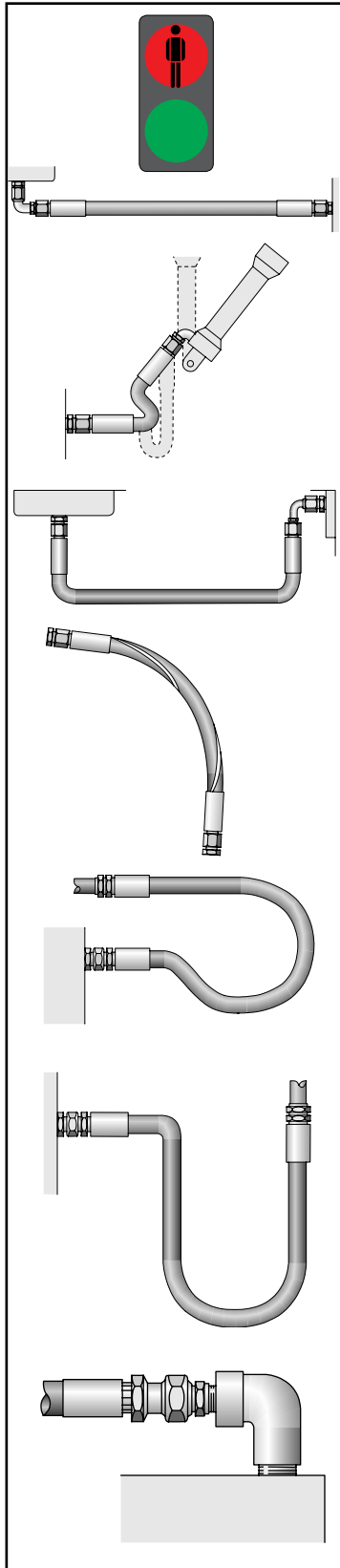

The routing of the hose assembly and the environment in which the hose assembly operates directly influence the service life of the hose assembly. The following diagrams indicate the correct routing of hose assemblies that will maximize its service life and assure a safe working functionality.

When hose installation is straight, there must be enough slack in the hose to allow for changes in length that occur when pressure is applied. When pressurized, hose that is too short may pull loose from its hose fittings or stress the hose fitting connections, causing premature metallic or seal failures.

The hose length must be determined so that the hose assembly has enough slack to allow the system components to move or vibrate without creating tension in the hose.

However, do not allow too much slack and therefore introduce the risk of the hose snagging on other equipment or rubbing on other components.

Mechanical straining of the hoses needs to be avoided, so the hose must not be bent below its minimum bend radius or twisted during installation. The minimum bending radii for each hose is stated in the hose tables in the catalog.

The plane of movement must also be considered and the hose routing selected accordingly.

Hose routing also plays an important role on the selection of the hose fittings, as the correct fittings can avoid straining the hoses, unnecessary hose length or multiple threaded joints.

right

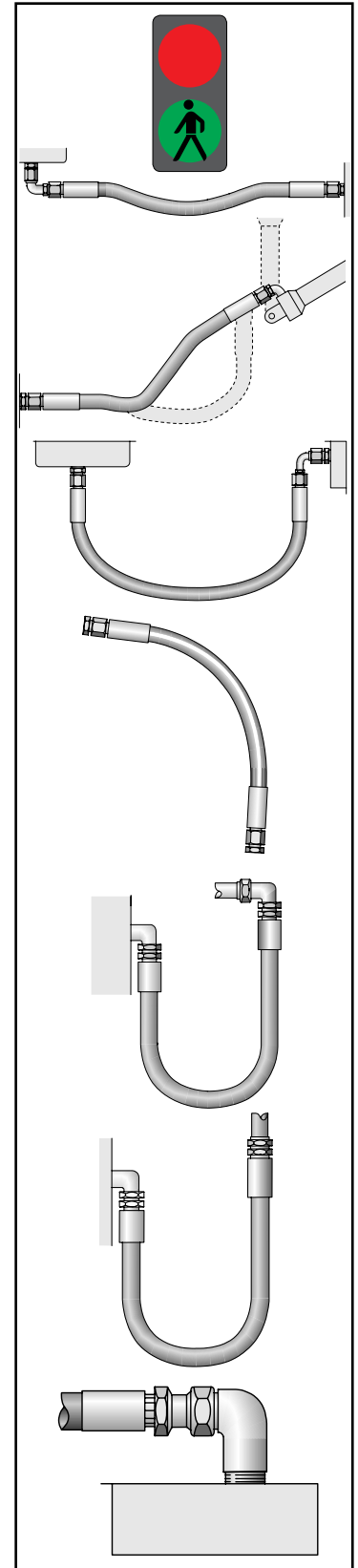

A

B

C

D

E



**wrong**

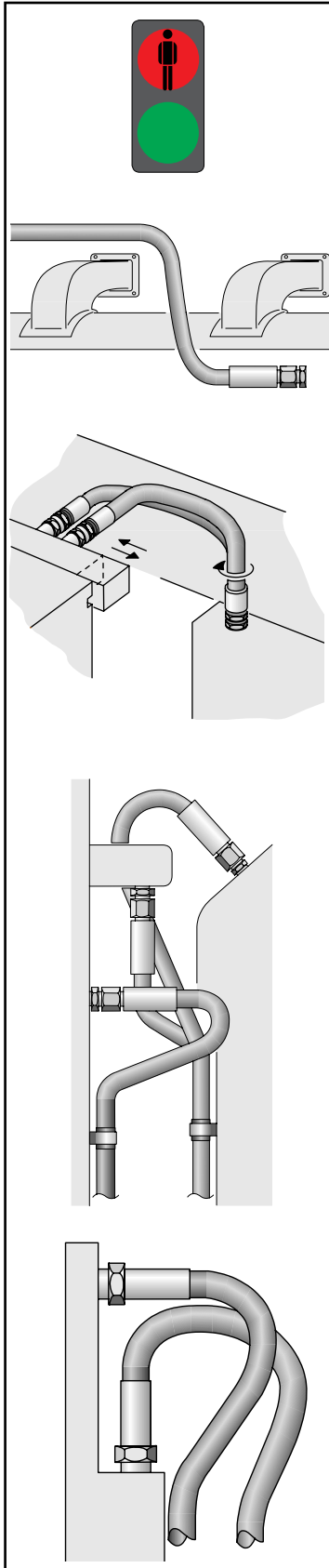

Correct clamping (holding/supporting) of the hose should be exercised to securely route the hose or to avoid the hose contacting surfaces that will cause the hose damage. It is however, vital that the hose be allowed to keep its functionality as a “flexible-pipe” and not be restricted from changing in length when under pressure.

It should also be noted that hoses for high- and low-pressure lines shall not be crossed or clamped together, as the difference in changes in length could wear the hose covers.

Hose should not be bent in more than one plane. If hose follows a compound bend, it shall be coupled into separate segments or clamped into segments that each flex in only one plane.

Hoses should be kept away from hot parts as high ambient temperatures shorten hose life. Protective insulation may need to be used in unusually high ambient temperature areas.

While the importance of the functionality is primary, the aesthetics and practicality of the installation should also be considered in the design. Maintenance might be necessary at some point in the future, so prohibitive design routings should be avoided.

**right**

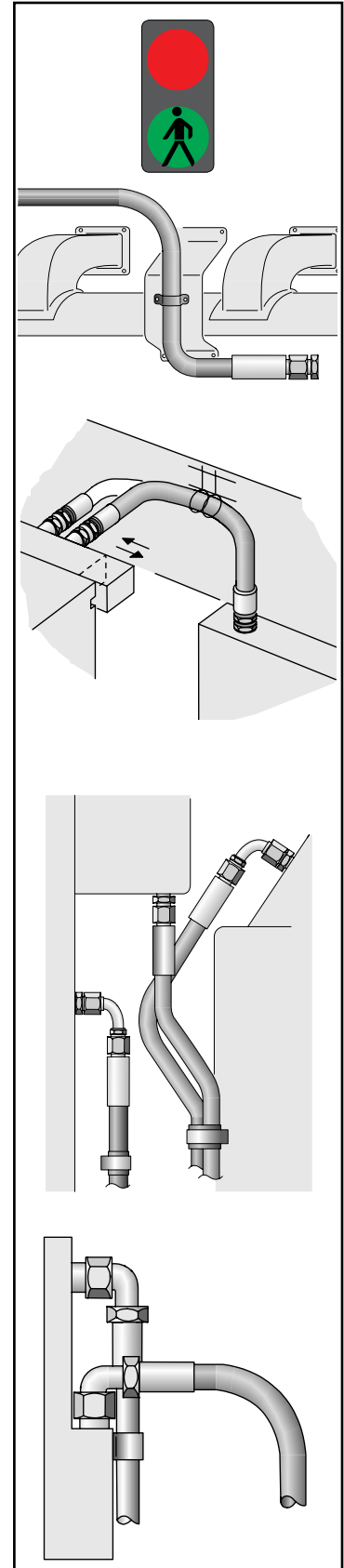

A

B

C

D

E

wrong

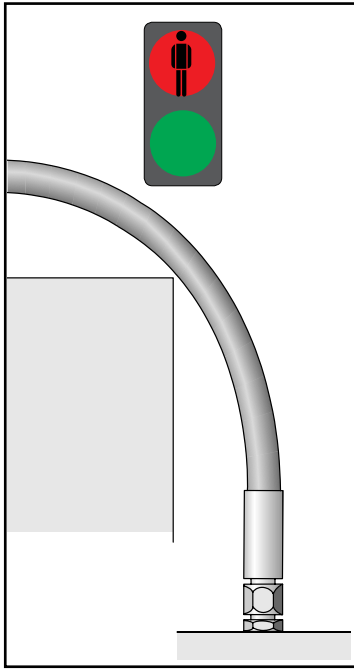

**Abrasive influences**

In general care should be taken so that the hose is not exposed to direct surface contact that will cause abrasive wearing of the outer cover (either hose to object or hose to hose contact). If however, the application is such that this cannot be avoided, either a hose with a higher abrasion resistant hose cover or a protective sleeve need to be used.

Parker **TOUGH COVER** (TC) or **SUPER TOUGH** (ST) covers offer 80 times or respectively 450 times the abrasion resistance of standard rubber covers.

right

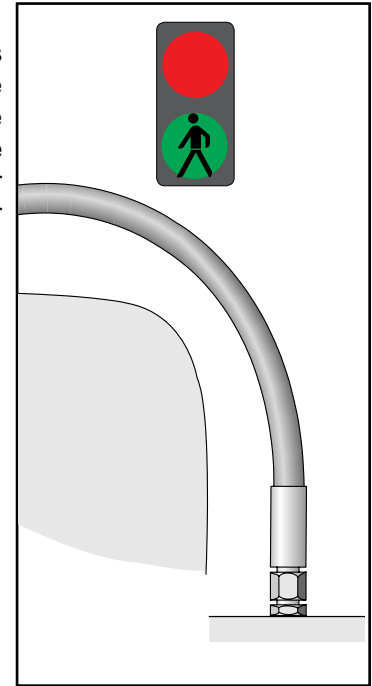

# Application

# Ferrule-Fix

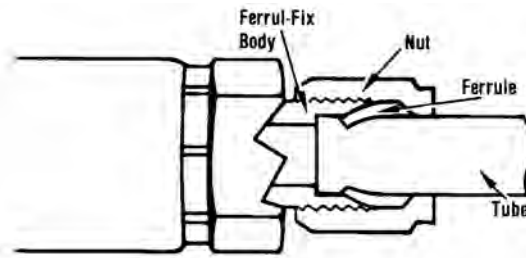

## Fast, on-the-job repair for ruptured bent tube hose assemblies and power steering lines.

The life of the combination tube-hose assembly is often limited to the service life of the hose alone. A replacement assembly may not be available, some equipment dealers are unable to stock all of the many odd tube configurations.

Parker FERRUL-FIX, a field attachable, reusable hose end fitting, now makes it possible to salvage the bent tube section of the original assembly for replacement. Most important, it gets you back into operation FAST!

- Gets you back in operation fast - No costly delays while replacement assemblies are rushed from the factory.
- Lets you reuse expensive bent tube ends with Parker Hose fittings - You can replace the hose at a fraction of the cost of complete assembly.

- Eliminates the need for emergency brazing or welding in the field - Ferrul-Fix can be assembled without special tools or equipment when using Parker Reusable Hose fittings.

**3-Piece Design** - Body, nut and ferrule. Wedging action of ferrule, when drawn down by nut, forms seal between body and ferrule, while cutting edge of ferrule "bites" into tube wall forming another positive seal.

**Visible Bite** - Extent of bite at cutting edge of ferrule is completely visible when fitting is dis-assembled, an important safety feature. Self-centering action assures even bite around circumference of tube.

**Parkerized Finish** - Ferrul-Lok fittings have the Parkerized black finish, providing "built-in" lubrication which reduces wrench torque required.

## Ferrul-Fix Installation Instructions



1. Cut the formed tube off squarely next to the permanent hose fitting. Lightly deburr the end of the tube internally and externally.
2. Disassemble the Ferrul-Fix fitting, and lubricate threads and both ends of the ferrule with Parker Ferulube.
3. Slide nut and ferrule onto tubing, with the long, straight end of the ferrule pointing toward the tube end.
4. Insert tube end into the Ferrul-Fix body until it bottoms against the shoulder. Slide ferrule inside body, and screw nut down finger tight.
5. Wrench nut down 1-3/4 turns to preset the ferrule.
6. Disconnect nut and inspect lead edge of ferrule to make certain that the biting edge has turned up a shoulder to a height of at least 50% of the ferrule and completely around the tube.
7. Assemble Ferrul-Fix fitting to hose. Refer to assembly instructions listed in appropriate fittings section. Do not assemble to hose before steps 1-6.
8. Reassemble tubing into Ferrul-Fix end and turn nut down easily until a sudden increase in force is evident. Turn bent tube to proper position if required. Using two wrenches, one on the fitting nipple hex and the other on the nut tighten nut an additional 1/6 turn (one wrench flat).

A

B

C

D

E

# Application

# Performance Standards and Specifications

Hose	Meets or Exceeds:						
	ISO	SAE	EN	NFPA	EES	DOT	UL
187	ISO 18752						
187TC	ISO 18752						
187ST	ISO 18752						
387	ISO 18752						
387TC	ISO 18752						
387ST	ISO 18752						
487	ISO 18752						
487TC	ISO 18752						
487ST	ISO 18752						
722 (-6 through -16)	ISO 18752						
722TC (-6 through -16)	ISO 18752						
722ST (-6 through -16)	ISO 18752						
787	ISO 18752						
787TC	ISO 18752						
787ST	ISO 18752						
797	ISO 18752						
797TC	ISO 18752						
797ST	ISO 18752						
201		SAE J517 100R5 / SAE J1402 AII				DOT FMVSS 106 AIR BRAKE - AII	
206		SAE J517 100R5 / SAE J1402 AII				DOT FMVSS 106 AIR BRAKE - AII	
213		SAE J1402 AI				DOT FMVSS 106 AIR BRAKE - AI	
221FR	ISO 7840	SAE J1527 A CLASS I / SAE J1942					
244		SAE J2064 B CLASS I					
266		SAE J1402 AII				DOT FMVSS 106 AIR BRAKE - AII	
271		SAE J1402 A				DOT FMVSS 106 AIR BRAKE - A	
285		SAE J2064 C (w/ 26 series)					
293		SAE J1402 AI				DOT FMVSS 106 AIR BRAKE - AI	
302	ISO 1436-1 Type 2SN	SAE J517 100R2AT / SAE J1942	EN 853 Type 2SN				
304							
422	ISO 1436-1 Type 1SN	SAE J517 100R1AT / SAE J1942	EN 853 Type 1SN				
424							
426		SAE J517 100R1AT / SAE J1942					
436	ISO 11237 Type R16	SAE J517 100R16					
471TC	ISO 11237 Type 2SC	SAE J1942	EN 857 Type 2SC				
471TC Twin Tough	ISO 11237 Type 2SC	SAE J1942	EN 857 Type 2SC				
471ST	ISO 11237 Type 2SC	SAE J1942	EN 857 Type 2SC				

### KEY TO UNDERSTANDING AGENCY APPROVALS FOR BUILDING HOSE ASSEMBLIES

**ABS** Approved assemblies can be manufactured at any location with Parker's permission. No restrictions.  
**DNV** Approved assemblies can only be manufactured in a Parker approved location that demonstrates a quality system and management program is in place and must be audited by DNV. Each location must be granted a "license" issued by Parker HPD for building hose assemblies. Three exist today; Davenport Iowa, Grimsby Canada, and Yangsan Korea.  
**BV** Approved assemblies can only be produced in a BV approved location that demonstrates a quality system and management program is in place. Each location must have an initial audit performed by BV before the "license" can be issued. Additionally, ongoing audits setup by BV will be required at each approved location. Davenport Iowa is our only approved assembler.  
**UL "Listed" CSA/CGA** Assemblies must be made at Davenport Iowa  
Assemblies must be made at Davenport Iowa

# Application Performance Standards and Specifications

Hose	Meets or Exceeds:			Agency Approvals:												
	ECE	CSA	AS/NZS	ABS	DNV	USCG	LR	MSHA	BV	CSA	RDW	UL	AGA	DOT	IMCI	NK
187																
187TC								•								
187ST								•								
387																
387TC				•	•	•	•	•								
387ST				•	•	•		•								
487																
487TC				•	•	•	•	•								
487ST				•	•	•		•								
722 (-6 through -16)						•										
722TC (-6 through -16)				•	•	•	•									
722ST (-6 through -16)				•	•	•	•									
787																
787TC				•	•	•	•	•								
787ST				•	•	•		•								
797																
797TC				•	•	•	•	•								
797ST				•	•	•		•								
201															•	
206															•	
213															•	
221FR				•	•	•	•	•							•	
244																
266															•	
271															•	
285																
293															•	
302				•	•	•			•							•
304																
422				•	•	•										
424																
426				•		•		•								
436				•		•		•								
471TC				•	•	•		•	•							
471TC Twin Tough				•	•	•		•	•							
471ST				•	•	•		•								

A

B

C

D

E

Notes:

(1) U.S.C.G./MTH (Marine Technical & Hazardous Materials Branch) hoses, hose assemblies and appropriate fittings meet 46CFR56.60-25(c) for use on commercial vessels. Hoses and hose assemblies meet the requirements of SAE J1942. Hose fittings meet the requirements of SAE J1475.

F = Fuel and lube systems.

H = Hydraulic Systems.

\*Some hoses are accepted for different pressures for F and H. Also, not all sizes are accepted for all applications. See HPD approval bulletin #APR-004 or consult the Parker Hose Products Division, Technical Services Department, for details. The Canadian Coast Guard accepts all hoses accepted by the U.S. Coast Guard.

(2) Det Norske Veritas (DnV) approvals are with permanent (crimp) type fittings only. See HPD Approval Bulletin #APR-006 or consult the Parker Hose Products Division, Technical Services Department, for details.

(3) Hose with MSHA (Mine Safety and Health Administration) approved flame resistant cover will be marked accordingly on the layline.

(4) 221FR is type accepted by Lloyd's Register. It meets the requirements of the American Boat and Yacht Council. 221FR is certified to meet the EC Directive 94/25/EC in accordance with ISO 7840.

**For questions on standards and specifications please contact the Hose Products' Technical Services Department at (440) 943-5700.**

Continued on next page

# Application Performance Standards and Specifications

Continued from previous page

Hose	Meets or Exceeds:						
	ISO	SAE	EN	NFPA	EES	DOT	UL
472TC		SAE J1942					
472LT			EN 857 Type 2SC				
482TC	ISO 1436-1 Type 1SN	SAE J517 100R1AT / SAE J1942	EN 853 Type 1SN				
482ST	ISO 1436-1 Type 1SN	SAE J517 100R1AT	EN 853 Type 1SN				
611HT		SAE J517 100R6	EN 854 Type R6				
722TC (-20 through -32)	ISO 3862-1 Type R12	SAE J517 100R12 / SAE J1942	EN 856 Type R12				
722ST (-20 through -32)	ISO 3862-1 Type R12	SAE J517 100R12 / SAE J1942	EN 856 Type R12				
722LT	ISO 3862-1 Type R12	SAE J517 100R12	EN 856 Type R12				
774							
792LT	ISO 3862-1 Type R15	SAE J517 100R15	EN 856 Type R15				
801							
804							
811		SAE J517 100R4 / SAE J1942					
811HT		SAE J517 100R4 / SAE J1942					
821							
821FR							
836							
881		SAE J517 100R4 / SAE J1942					
F42							
JK	ISO 1436-1 Type 2SN	SAE J517 100R2AT	EN 853 Type 2SN	NFPA 1936	EES 116-4		
SS23CG				NFPA 58			UL 21
SS25UL (-4 through -12)				NFPA 58			UL 21
SS25UL-AGA (-4, -6, -8)							

**KEY TO UNDERSTANDING AGENCY APPROVALS FOR BUILDING HOSE ASSEMBLIES**

ABS Approved assemblies can be manufactured at any location with Parker's permission. No restrictions.  
 DNV Approved assemblies can only be manufactured in a Parker approved location that demonstrates a quality system and management program is in place and must be audited by DNV. Each location must be granted a "license" issued by Parker HPD for building hose assemblies. Three exist today; Davenport Iowa, Grimsby Canada, and Yangsan Korea.

BV Approved assemblies can only be produced in a BV approved location that demonstrates a quality system and management program is in place. Each location must have an initial audit performed by BV before the "license" can be issued. Additionally, ongoing audits setup by BV will be required at each approved location. Davenport Iowa is our only approved assembler.  
 UL "Listed" Assemblies must be made at Davenport Iowa  
 CSA/CGA Assemblies must be made at Davenport Iowa

# Application Performance Standards and Specifications

Hose	Meets or Exceeds:			Agency Approvals:												
	ECE	CSA	AS/NZS	ABS	DNV	USCG	LR	MSHA	BV	CSA	RDW	UL	AGA	DOT	IMCI	NK
472TC				•	•	•		•								
472LT						•		•								
482TC						•		•								
482ST								•								
611HT								•								
721								•								
722ST (-20 through -32)				•	•	•	•	•								
722LT								•								
774																
792LT								•								
801								•								
804																
811						•										
811HT				•		•		•								
821																
821FR																
836								•								
881				•		•		•								
F42																
JK								•								
SS23CG	ECE R110 / ECE R67	CDA 8.1 2015 Type III								•	•	•				
SS25UL (-4 through -12)												•				
SS25UL-AGA (-4, -6, -8)													•			

A

B

C

D

E

Notes:

(1) U.S.C.G./MTH (Marine Technical & Hazardous Materials Branch) hoses, hose assemblies and appropriate fittings meet 46CFR56.60-25(c) for use on commercial vessels. Hoses and hose assemblies meet the requirements of SAE J1942. Hose fittings meet the requirements of SAE J1475.

F = Fuel and lube systems.

H = Hydraulic Systems.

\*Some hoses are accepted for different pressures for F and H. Also, not all sizes are accepted for all applications. See HPD approval bulletin #APR-004 or consult the Parker Hose Products Division, Technical Services Department, for details. The Canadian Coast Guard accepts all hoses accepted by the U.S. Coast Guard.

(2) Det Norske Veritas (DnV) approvals are with permanent (crimp) type fittings only. See HPD Approval Bulletin #APR-006 or consult the Parker Hose Products Division, Technical Services Department, for details.

(3) Hose with MSHA (Mine Safety and Health Administration) approved flame resistant cover will be marked accordingly on the layline.

(4) 221FR is type accepted by Lloyd's Register. It meets the requirements of the American Boat and Yacht Council. 221FR is certified to meet the EC Directive 94/25/EC in accordance with ISO 7840.

**For questions on standards and specifications please contact the Hose Products' Technical Services Department at (440) 943-5700.**

# Application

# Standards and Specifications

## JIS - Adapters

JIS B8363 Code	Parker Part Number	Mates with End Configuration
A1	F3T4	FU
A2	F3P4	GU
A3	F63P4	UT
E1	C3T4	FU
E2	C3P4	GU
E3	V3T4	FU
E4	V3P4	GU

Note: See website at [www.Parker/tfd.com](http://www.Parker/tfd.com), Catalog 4300 or call (614) 279-7070 for additional information.

## JIS - Hose Fittings

JIS B8363 Code	Parker End Configuration Code	Fitting Series 43	Fitting Series 70	Fitting Series 71	Fitting Series 79
R	UT	X		X	
F	FU	X		X	
C	GU	X	X	X	
MF	MU	X		X	
S	15	X	X	X	
4S	17	X	X	X	
9S	19	X	X	X	
H	6A		X	X	X
4H	6F			X	X
9H	6N		X	X	X

Note: Parker Hose Standards are listed on page E-14 thru E-17



# Application

# Assembly Methods

## JIC 37° and SAE 45° Flare

Parker's recommended assembly method for JIC 37° flare and SAE 45° flare is the Flats From Wrench Resistance (FFWR) method. This includes steel as well as other materials.

The torque values assigned by size are for reference only, and are only applicable to Parker system components using the FFWR method with trivalent chromate passivation on zinc plating of carbon steel components without lubrication.

Dash Size	Flats From Wrench Resistance (FFWR)	Swivel Nut Torque	
		Newton Meters (Ref)	Pound Feet (Ref)
-4	2	18	13
-5	2	19	14
-6	1-1/2	30	22
-8	1-1/2	57	42
-10	1-1/2	81	60
-12	1-1/4	114	84
-16	1	160	118
-20	1	228	168
-24	1	265	195
-32	1	360	265

## Seal-Lok®

Parker's recommended assembly method for Seal-Lok® connections is the torque method.

Dash Size	Swivel Nut Torque		Flats From Wrench Resistance (FFWR)
	Newton Meters (+10% / -0)	Pound Feet (+10% / -0)	
-4	25	18	1/2 - 3/4
-6	40	30	1/2 - 3/4
-8	55	40	1/2 - 3/4
-10	80	60	1/2 - 3/4
-12	115	85	1/3 - 1/2
-16	150	110	1/3 - 1/2
-20	205	150	1/3 - 1/2
-24	315	230	1/3 - 1/2
-32	-	-	-

Note: The assembly torques listed are higher than the test torques published in SAE J1453.

## Torque Conversion Equivalents

Torque Conversion Equivalents		
Pound Inch - Pound Foot - Newton Meter		
Pound Foot x 12	=	Pound Inch
Pound Foot x 1.356	=	Newton Meter
Newton Meter x 8.850	=	Pound Inch
Newton Meter x 0.737	=	Pound Foot
Pound Inch x .083	=	Pound Foot
Pound Inch x 0.113	=	Newton Meter

The torque values for other materials are as follows:

- Brass fittings and adapters - 65% of the torque value for steel.
- Stainless steel, and Monel - Use 5% higher than listed for steel. Threads to be lubricated for these materials.
- Dissimilar metals - use torque value designated for the lower of the two metals.
- All fittings are dry except as noted above.

The Flats From Wrench Resistance (FFWR) and torque values listed above are consistent with the values recommended by Parker Tube Fittings Division (614) 279-7070 or [www.parker.com/tfd](http://www.parker.com/tfd).



## Identifying Fitting Types

In general fittings can be identified by their visual appearance, their sealing surface/sealing type or by their thread type/form. Viewing the following pages, the visual identification will be self explanatory. The sealing mechanism and the method of thread identification, however, needs further explanation

### Determining Sealing Mechanisms:

- Thread interface
- O-ring
- Matching angle or metal-to-metal joint
- Mated angle with O-ring

### Thread Interface

The sealing is assured by the flattening of the edges of the threads when the male is screwed into the female fitting. Typically the front of the male fittings is narrower than the back of the fittings – often referred to as tapered threads.

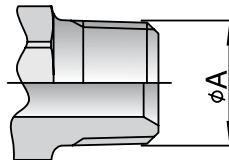

### O-ring

The O-ring on the male is compressed against the corresponding female and assures the seal. This type of sealing mechanism should be the preferred choice for high-pressure applications.

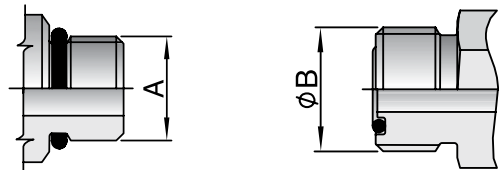

### Matching Angle or Metal-to-Metal Joint

Sealing takes place where the two angled faces of the male and corresponding female meet and are wedged into one another by the tightening of the threaded nut. The sealing surfaces can either be convex or concave (seat) on the male or in the head of the pipe of the female as shown.

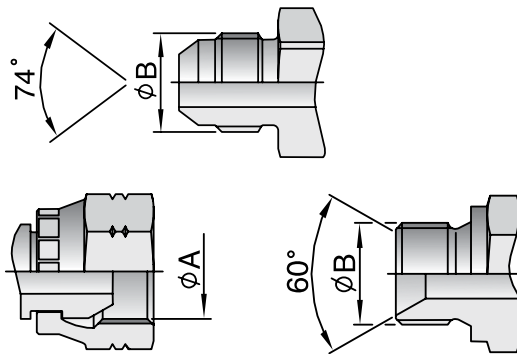

### Matching Angle with O-ring

These fittings combine the functionality of both the matching angle seal with the O-ring. The O-ring is in the angled sealing surface of the fitting so that when the threaded male and female are screwed together the sealing surfaces wedge together and at the same time deform the O-ring between them.

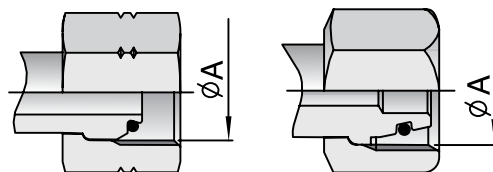

## Determining the Thread Type

In general of the threads of various fittings look similar and hinder the easy identification of the thread. To assure the correct identification, the threads must be measured and compared to the tables listed in the following section.

### Thread Gauge

Using a thread gauge, the number of threads per inch can be determined. Holding the gauge and coupling threads in front of a lighted background helps to obtain an accurate measurement.

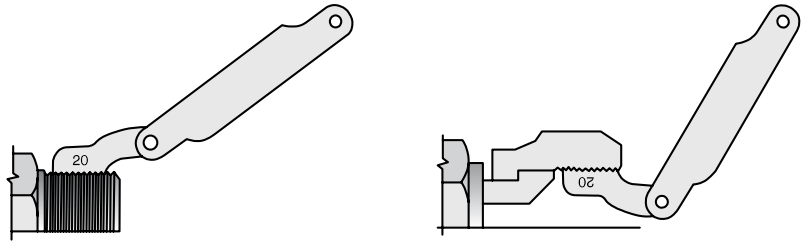

### Caliper Measure

A vernier caliper should be used to measure the thread diameter of the largest point. (Outside diameter (O.D.) of male threads – Inside Diameter (I.D.) of female threads.)

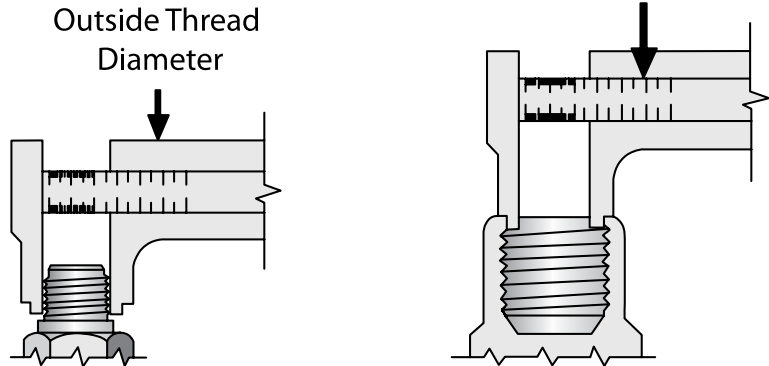

# German DIN Hose Fittings

Often referred to as metric fittings, these fittings seal using the angled sealing surfaces (metal-to-metal) or the combination of metal-to-metal with O-rings.

They are available in very light (LL), light (L) or heavy series (S).

The sealing face angles are either 24° with or without O-rings, or 24°/60° universal cones.

Identification is made by measuring the thread size and also the tube outside diameter.

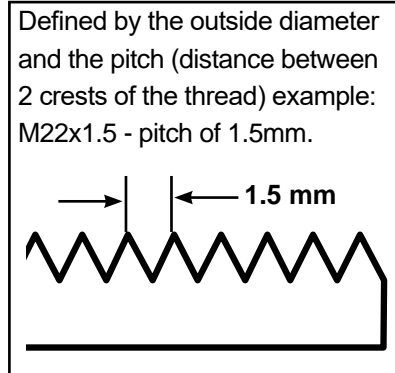

## DIN Very Light Series (LL)

The male 60° cone will mate with the female 60° cone only.

The male has a 60° sealing angle (seat) and straight metric thread.

The female has a 60° seat and straight metric thread.

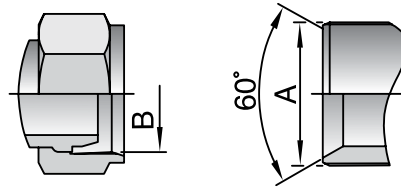

Standard

### DIN 20078 Part 3 <sup>1)</sup>

Parker end configurations  
**C0**

## DIN Light (L) and Heavy Series (S) without O-ring

The male 24° cone will mate with the female universal 24° or 60° cone only.

The male has a 60° sealing angle (seat) and straight metric threads.

The female has a 24° and 60° universal seat and straight metric threads.

Tube O.D. (DN)	Thread metric	ØA (mm)	ØB (mm)
20	M30x1.5	30.00	28.50
25	M38x1.5	38.00	36.50
32	M45x1.5	45.00	43.50
40	M52x1.5	52.00	50.50
50	M65x2	65.00	63.00

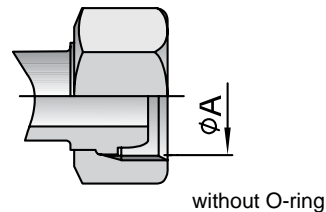

Standard

### DIN 20078 Part 2 <sup>1)</sup>

(previously known as  
DIN 20078 A, D & E)

Parker end configurations  
light series

### C3, C4, C5, C6

(Often also referred to as “Ball nose cones”)

<sup>1)</sup> obsolete standard, no exact replacement

**DIN 24° Light (L) and Heavy Series (S) with O-ring**

The male has a 24° sealing angle cone seat with straight metric threads.

The female has a 24° convex cone with O-ring and a swivel straight metric threaded nut.

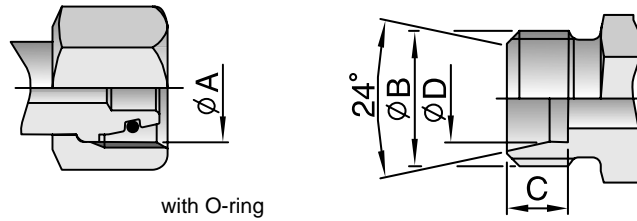

with O-ring

Standard

**ISO 12151-2 / ISO 8434-1 & ISO 8434-4**

(Previously

DIN 20 078 Part 4, 5, 8, 9)

Parker end configurations

light series

**CA, CE, CF, D0**

Parker end configurations

heavy series

**C9, 0C, 1C, D2**

Tube O.D. (mm)	Spec.	Thread metric	ØA (mm)	ØB (mm)	C (mm)	ØD (mm)
6.00	6L	M12X1.5	10.50	12.00	7.00	6.20
6.00	6S	M14X1.5	12.50	14.00	7.00	6.20
8.00	8L	M14x1.5	12.50	14.00	7.00	8.20
8.00	8S	M16x1.5	14.50	16.00	7.00	8.20
10.00	10L	M16x1.5	14.50	16.00	7.00	10.20
10.00	10S	M18x1.5	16.50	18.00	7.50	10.20
12.00	12L	M18x1.5	16.50	18.00	7.00	12.20
12.00	12S	M20x1.5	18.50	20.00	7.50	12.20
14.00	14S	M22x1.5	20.50	22.00	8.00	14.20
15.00	15L	M22x1.5	20.50	22.00	7.00	15.20
16.00	16S	M24x1.5	22.50	24.00	8.50	16.20
18.00	18L	M26x1.5	24.50	26.00	7.50	18.20
20.00	20S	M30x2	27.90	30.00	10.50	20.20
22.00	22L	M30x2	27.90	30.00	7.50	22.20
25.00	25S	M36x2	33.90	36.00	12.00	25.20
28.00	28L	M36x2	33.90	36.00	7.50	28.20
30.00	30S	M42x2	39.90	42.00	13.50	30.20
35.00	35L	M45x2	42.90	45.00	10.50	35.30
38.00	38S	M52x2	49.90	52.00	16.00	38.30
42.00	42L	M52x2	49.90	52.00	11.00	42.30



## British Standard Pipe (BSP)

Also referred to as Whitworth threads, the BSP thread type fittings seal use metal-to-metal angled surfaces or a combination of metal-to-metal and an O-ring.

The angle of the sealing surfaces is 60° for both forms.

There are two popular thread forms: British Standard Pipe Parallel (BSPP) and British Standard Pipe Tapered (BSPT).

Identification is made by measuring the outside diameter of the thread and the number of threads per inch (25.4 mm)

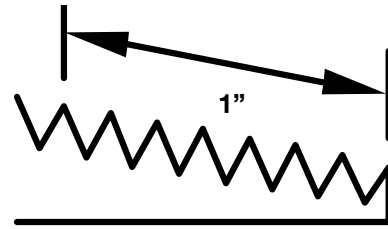

### BSPP BS5200

Parker end configurations  
92, B1, B2, B4, D9

**BSPP**  
metal-to-metal with O-ring  
Standard

#### ISO 12151-6

Some Parker end configurations may be non-standard parts.

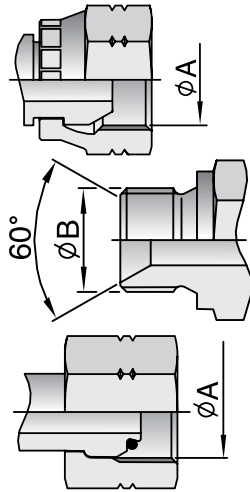

Tube I.D./O.D. (mm)	Size	Thread BSP	ØA (mm)	ØB (mm)
6/10	-2	1/8x28	8.60	9.70
8/13	-4	1/4x19	11.50	13.20
12/17	-6	3/8x19	14.90	16.70
15/21	-8	1/2x14	18.60	20.90
18/23	-10	5/8x14	20.60	22.90
20/27	-12	3/4x14	24.10	26.40
26/34	-16	1x11	30.30	33.20
33/42	-20	1-1/4x11	38.90	41.90
40/49	-24	1-1/2x11	44.90	47.80
50/60	-32	2x11	56.70	59.60

### BSPT

fittings seal through the thread interface mechanism. Care should be taken not to confuse the BSPT fitting with the NPTF male fitting. BSPT has a 55° thread angle. NPTF has 60° thread angle.

Parker end configuration  
91

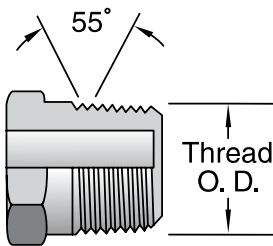

Tube I.D./O.D. (mm)	Size	Thread BSP	ØA (mm)
5/10	-2	1/8x28	9.73
8/13	-4	1/4x19	13.16
12/17	-6	3/8x19	16.66
15/21	-8	1/2x14	20.96
20/27	-12	3/4x14	26.44
26/34	-16	1x11	33.25
33/42	-20	1-1/4x11	41.91
40/49	-24	1-1/2x11	47.80
50/60	-32	2x11	59.61

### BSP Flat Seal

These fittings have BSP parallel threads but the sealing surface is flat. The seal is made when the composite seal is compressed against the female flat face.

Some Parker end configurations may be non-standard parts.

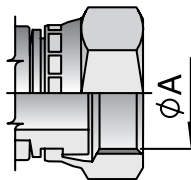

Tube I.D./O.D. (mm)	Size	Thread BSP	ØA (mm)
6/10	-2	1/8x28	8.6
8/13	-4	1/4x19	11.5
12/17	-6	3/8x19	14.9
15/21	-8	1/2x14	18.6
18/23	-10	5/8x14	20.6
20/27	-12	3/4x14	24.1
26/34	-16	1x11	30.3

## French Gas Fittings

Typical to the French market the French Gas fittings have a 24° sealing surfaces seat with metric straight threads. Although similar to German DIN fittings the threads differ in some sizes as the French Gas fittings have fine threads in all sizes whereas the German DIN fittings use standard threads in the larger sizes.

### French Metric 24° Cone Gas Fittings

The sealing mechanism is metal-to-metal.

The fittings are not specified in any international standard.

Some Parker end configurations may be non-standard parts.

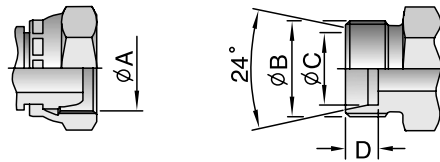

Tube O.D. (mm)	Spec.	Thread metric	ØA (mm)	ØB (mm)	ØC (mm)	D (mm)
6.00	6N	M12x1	11.00	12.00	6.20	9.00
8.00	8N	M14x1.5	12.50	14.00	8.15	9.00
10.00	10N	M16x1.5	14.50	16.00	10.20	9.00
12.00	12N	M18x1.5	16.50	18.00	12.15	9.00
13.25	13G	M20x1.5	18.50	20.00	13.50	9.00
14.00	14N	M20x1.5	18.50	20.00	14.15	9.00
15.00	15N	M22x1.5	20.50	22.00	15.15	9.00
16.00	16N	M24x1.5	22.50	24.00	16.15	9.00
16.75	17G	M24x1.5	22.50	24.00	17.00	9.00
18.00	18N	M27x1.5	25.50	27.00	18.15	9.00
20.00	20N	M27x1.5	25.50	27.00	20.15	9.00
21.25	21G	M30x1.5	28.50	30.00	21.50	9.00
22.00	22N	M30x1.5	28.50	30.00	22.15	9.00
25.00	25N	M33x1.5	31.50	33.00	25.15	9.00
26.75	27G	M36x1.5	34.50	36.00	27.00	9.00
28.00	28N	M36x1.5	34.50	36.00	28.25	9.00
30.00	30N	M39x1.5	37.50	39.00	30.25	9.00
32.00	32N	M42x1.5	40.50	42.00	32.25	9.00
33.25	34G	M45x1.5	43.50	45.00	33.80	9.00
35.00	35N	M45x1.5	43.50	45.00	35.25	9.00
38.00	38N	M48x1.5	46.50	48.00	38.25	9.00
40.00	40N	M52x1.5	50.50	52.00	40.35	9.00
42.25	42G	M52x1.5	50.50	52.00	42.55	9.00
48.25	49G	M58x2	55.90	58.00	49.00	11.00



# North American Thread Types

This type of fitting uses the thread interface to seal and as such has a tapered thread that deforms and forms the seal.

They have 30° sealing angle surfaces, forming a 60° inverted (concave) seat. The fittings are most frequently seen on machines of US origin.

## Dryseal American Standard Taper Pipe Thread (NPTF)

The NPTF male will mate with the NPTF, NPSF, or NPSM females. Care should be taken not to confuse the NPTF fitting with the BSPT male fitting. NPTF fittings have a 60° thread angle.

BSPT has a 55° thread angle.

Standard

**SAE J516**

Parker end configuration

**01**

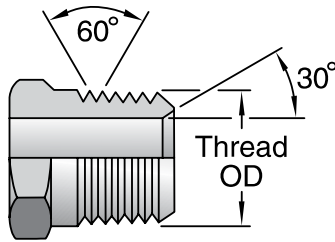

ØA dimension is measured on the 4th pitch of the thread

Size	Thread NPTF	ØA (mm)	ØB (mm)
-2	1/8x27	10.24	8.73
-4	1/4x18	13.61	11.90
-6	3/8x18	17.05	15.90
-8	1/2x14	21.22	19.05
-12	3/4x14	26.56	24.60
-16	1x11.5	33.22	30.95
-20	1-1/4x11.5	41.98	39.69
-24	1-1/2x11.5	48.05	45.24
-32	2x11.5	60.09	57.15

## SAE JIC 37°

Commonly referred to as JIC fittings, these metal-to-metal sealing type fittings have a 37° flare (sealing surface angle) and straight United National Fine Threads (UNF).

The original design specification for the fittings comes from the Society of Automotive Engineers (SAE) and these fittings are the most common American fitting types in Europe.

Standard

**ISO 12151-5, ISO8434-2 and**

**SAE J516**

Parker JIC hose fittings are fully compatible with Parker Triple-Lok Tube Fittings and adapters.

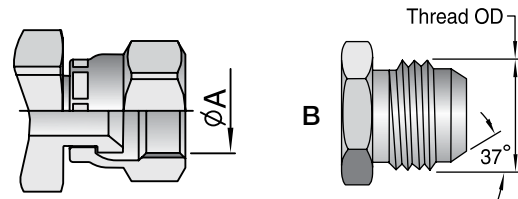

Tube O.D. (inch)	Tube O.D. (mm)	Thread UNF	Size	ØA (mm)	ØB (mm)
3/16		3/8x24	-3	8.60	9.50
1/4	6	7/16x20	-4	10.00	11.10
5/16	8	1/2x20	-5	11.60	12.70
3/8	10	9/16x18	-6	13.00	14.30
1/2	12	3/4x16	-8	17.60	19.10
5/8	14-15-16	7/8x14	-10	20.50	22.20
3/4	18-20	1-1/16x12	-12	24.60	27.00
7/8	22	1-3/16x12	-14	28.30	30.10
1	25	1-5/16x12	-16	31.30	33.30
1-1/4	30-32	1-5/8x12	-20	39.20	41.30
1-1/2	38	1-7/8x12	-24	45.60	47.60
2		2-1/2x12	x32	61.50	63.50

Parker end configurations

**03, 06/68, 37/3V, 39/3W, 41/3Y, L9**



### SAE 45° Flare

The angle of the flare is commonly used as a name when referring to these metal-to-metal sealing fittings.

The female fittings have a 90° concave inverted seat, created by the 45° angle sealing surfaces.

The SAE 45° flare male will mate with an SAE 45° flare female only or a dual seat JIC 37°/SAE45°.

Standard

### SAE J516

Parker end configurations

**04, 08/68, 77/3V, 79/3W, 81/3Y**

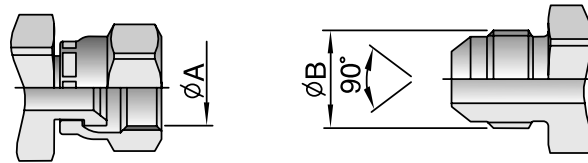

Tube O.D. (inch)	Size	Thread UNF	ØA (mm)	ØB (mm)
1/4	x4	7/16x20	9.90	11.10
5/16	-5	1/2x20	11.50	12.70
3/8	-6	5/8x18	14.30	15.90
1/2	-8	3/4x16	17.50	19.10
5/8	-10	7/8x14	20.60	22.20
3/4	-12	1-1/16x14	25.00	27.00

### SAE O-ring (Boss Type)

This male fitting has straight threads, a sealing face and an O-ring. It is compatible only with female boss type fittings generally found in the ports of machines. Sealing is achieved through the O-ring of the male and through the sealing face of the female.

Parker end configuration

**05**

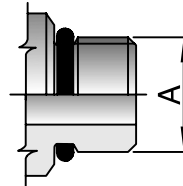

Thread UNF	Size	ØA (mm)
5/16x24	-2	7.93
3/8x24	-3	9.52
7/16x20	-4	11.11
1/2x20	-5	12.70
9/16x18	-6	14.28
3/4x16	-8	19.10
7/8x14	-10	22.22
1-1/16x12	-12	27.00
1-3/16x12	-14	30.10
1-5/16x12	-16	33.30
1-5/8x12	-20	41.30
1-7/8x12	-24	47.60
2-1/2x12	-32	63.50

### O-ring Face Seal (ORFS)

ORFS fittings are becoming the most popular international fitting type used on global OEM machines due to their high level of sealing and their good vibration resistance. The fittings use the O-ring compression mechanism to seal.

The female fittings have flat faces and straight threaded UNF swivel nuts. The male fittings have the O-ring in a groove in the flat face.

Seen as a major advantage, these fittings offer the possibility to build the hose assemblies into fixed distances/spaces, without having to move back other system components due the flat faces of the male and female fittings – the hose assembly can be slotted in.

Standard

**ISO 12151-1, ISO8434-3 and SAE J516**

Parker end configurations

**JC, JM/J0, JS, JU, J1, J3, J5, J7, J9**

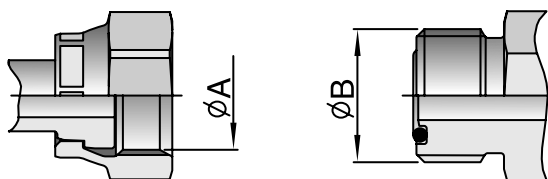

Tube O.D. (inch)	Tube O.D. (mm)	Thread UNF	Size	ØA (mm)	ØB (mm)
1/4	6	9/16x18	-4	13.00	14.20
3/8	10	11/16x16	-6	15.90	17.50
1/2	12	13/16x16	-8	19.10	20.60
5/8	16	1x14	-10	23.80	25.40
3/4	20	1-3/16x12	-12	28.20	30.10
1	25	1-7/16x12	-16	34.15	36.50
1-1/4	32	1-11/16x12	-20	40.50	42.90
1-1/2	38	2x12	-24	48.80	50.80

## Flange Fittings Code 61 and Code 62

The 4-bolt split flange (or full flange) fitting is used worldwide for connecting high-pressure hoses typically to pumps, motors and cylinders, where the hose assemblies are subjected to large pressure loadings.

The sealing mechanism is through compression of the O-ring in the face of the flange head against the surface of the port/connection.

The flange fittings are generally separated into two pressure classes referred to as 3000 psi (SFL) or 6000 psi (SFS).

ISO 12151-3 refers to the flange fittings as code 61 for the 3000 psi and code 62 for the 6000 psi.

In addition to these flanges, custom-specific Komatsu® and CATERPILLAR® flanges can also be found in the market.

Parker end configurations

Code 61 (3000 psi)

**15, 16, 17, 19, P5, P7, P9**

5000 psi (Code 61 dimensions)

**4A, 4F, 4N**

Code 62 (6000 psi)

**6A, 6F, 6N, PA, PF, PN, 89**

Caterpillar flange

**XA, XF, XG, XN**

Although not in the SAE or the ISO standard the size -10 (5/8) flange head is gaining popularity.

This flange is often found on Komatsu equipment or hydrostatic drives in agricultural machines.

- Standard Code 61 for 3000 to 5000 psi max., depending on size
- High Pressure Code 62 for 6000 psi max. regardless of size

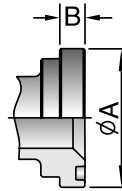

Flange (inch)	Size	Code 61 MPa / psi	Code 62 MPa / psi
1/2	-8	34.5 / 5000	41.3 / 6000
3/4	-12	34.5 / 5000	41.3 / 6000
1	-16	34.5 / 5000	41.3 / 6000
1-1/4	-20	27.5 / 4000	41.3 / 6000
1-1/2	-24	20.7 / 3000	41.3 / 6000
2	-32	20.7 / 3000	41.3 / 6000

Note: 5000 psi in size -20/-24/-32 with 4A,4F and 4N fittings and 50H flange halves.

### Code 61 – SAE – 3000 psi

Flange (inch)	Size	ØA (mm)	B (mm)	O-Ring
1/2	-8	30.18	6.73	18.64x3.53
3/4	-12	38.10	6.73	24.99x3.53
1	-16	44.45	8.00	32.92x3.53
1-1/4	-20	50.80	8.00	37.69x3.53
1-1/2	-24	60.33	8.00	47.22x3.53
2	-32	71.42	9.53	56.74x3.53
2-1/2	-40	84.12	9.53	69.44x3.53
3	-48	101.60	9.53	85.32x3.53

### Code 62 – SAE – 6000 psi

Flange (inch)	Size	ØA (mm)	B (mm)	O-Ring
1/2	-8	31.75	7.75	18.64x3.53
3/4	-12	41.28	8.76	24.99x3.53
1	-16	47.63	9.53	32.92x3.53
1-1/4	-20	53.98	10.29	37.69x3.53
1-1/2	-24	63.50	12.57	47.22x3.53
2	-32	79.38	12.57	56.74x3.53

### CATERPILLAR®

Flange (inch)	Size	ØA (mm)	B (mm)	O-Ring
3/4	-12	41.28	14.22	25.40x5.00
1	-16	47.63	14.22	31.90x5.00
1-1/4	-20	53.98	14.22	38.20x5.00
1-1/2	-24	63.50	14.22	44.70x5.00

### Komatsu®

Flange (inch)	Size	ØA (mm)	B (mm)	O-Ring
5/8	-10	34.25	6.00	21.7x3.5

### 4-Bolt Split Flange

A 4-bolt split flange is used to attach the flange fittings to their ports.

- Standard Code 61 for 3000 to 5000 psi max., depending on size
- High Pressure Code 62 for 6000 psi max., regardless of size

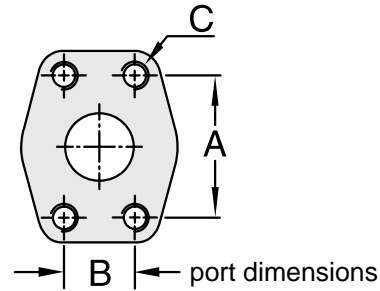

#### Code 61 – SAE – 3000 psi

Flange (inch)	Size	A (mm)	B (mm)	C	
				(inch)	(metr.)
1/2	-8	38.1	17.5	5/16x18	M8x1.25
3/4	-12	47.6	22.3	3/8x16	M10x1.5
1	-16	52.4	26.2	3/8x16	M10x1.5
1-1/4	-20	58.7	30.2	7/16x14	M10x1.5
1-1/2	-24	69.9	35.7	1/2x13	M12x1.75
2	-32	77.8	42.8	1/2x13	M12x1.75*

#### Code 62 – SAE – 6000 psi

Flange (inch)	Size	A (mm)	B (mm)	C	
				(inch)	(metr.)
1/2	-8	40.5	18.2	5/16x18	M8x1.25
3/4	-12	50.8	23.8	3/8x16	M10x1.5
1	-16	57.2	27.8	7/16x14	M12x1.75
1-1/4	-20	66.7	31.8	1/2x13	M12x1.75*
1-1/2	-24	79.4	36.5	5/8x11	M16x2
2	-32	96.8	44.4	3/4x10	M20x2.5

\*M14x2 still used in the market but no longer in accordance with ISO 6162

### Replacing Caterpillar® 6000 PSI Flange Fittings with SAE Code 62 Flange Fittings and Parker “Caterpillar®” Style Flange Fittings

Caterpillar® has a proprietary 6000 PSI hydraulic flange fitting for use on their equipment. This fitting is similar to the SAE Code 62 hydraulic flange (SAE J518). Flange diameters and bolt hole spacing are the same. The Caterpillar® flange head is thicker (.560” in all sizes) and the configuration and location of the O-ring groove is different, requiring the use of a special O-ring.

The Caterpillar® 6000 PSI flange fitting can be replaced with a Parker “Caterpillar®” style flange fitting

such as the 1XA78 using the existing Caterpillar® flange halves and bolts. In this case the XARG O-ring would be used. The fitting could also be replaced with a standard Code 62 flange fitting such as the 16A78. In this case use HFH flange halves or the HFHFHK kit with the standard SAE O-ring (711510).

Do not use the Caterpillar® 6000 PSI split flange halves on SAE Code 62 flange fittings or SAE Code 62 flange halves on Caterpillar® 6000 PSI flange fittings.

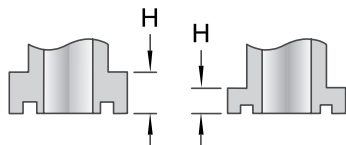

Size		H (in)	
		Caterpillar®	SAE Code 62
3/4	(-12)	.560	.345
1	(-16)	.560	.375
1-1/4	(-20)	.560	.405
1-1/2	(-24)	.560	.495

Procedure	P-ring P/N	Flange Half P/N	Flange Kit P/N
When replacing Caterpillar® 6000 PSI Flange Fittings with Parker “Caterpillar® Style” Fittings:	XARG-Size	Use existing flange halves and bolts	Use existing flange halves and bolts
When replacing Caterpillar® 6000 PSI Flange Fittings with SAE Code 62 Flange Fittings:	711510*	HFH-Size	HFHFHK-Size

# Japanese Fittings

The Japanese Industrial Standard (JIS) is seen on most Japanese equipment and uses a 30° sealing angle seat and either British Standard Pipe Parallel or metric threads.

Care must be taken not to confuse the JIS fittings with BSP or JIC fittings.

## Japanese fittings - JIS

The sealing mechanism of the fittings is the 30° metal-to-metal angled surfaces

Parker end configurations

**MU, XU (Metric)**

**FU (BSP)**

### JIS 30° metric

Symbol	Thread metric	ØA (mm)	ØB (mm)
MU-6	M14x1.5	12.50	14.00
MU-9	M18x1.5	16.50	18.00
MU-12	M22x1.5	20.50	22.00
MU-15	M27x2	25.00	27.00
MU-19	M27x2	25.00	27.00
MU-25	M33x2	31.00	33.00
MU-32	M42x2	40.00	42.00
MU-38	M50x2	48.00	50.00
MU-50	M60x2	58.00	60.00

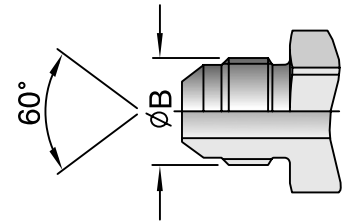





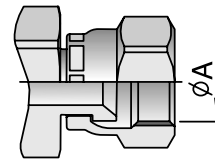



### JIS 30° BSP









Symbol	Thread BSP	ØA (mm)	ØB (mm)
GUI-3	1/8x28	8.60	9.70
GUI-5-6	1/4x19	11.50	13.20
GUI-8-9	3/8x19	14.90	16.70
GUI-12	1/2x14	18.60	20.90
GUI-15-19	3/4x14	24.10	26.40
GUI-25	1x11	30.30	33.20
GUI-32	1-1/4x11	38.90	41.90
GUI-38	1-1/2x11	44.90	47.80
GUI-50	2x11	56.70	59.60



# Application

# Thread Guide

								
size	NPTF Pipe Thread Size	SAE (JIC) 37 Flare Thread Size	SAE 45 Flare Thread Size	O-Ring Style Straight Thread Size	SAE Inverted Flare Thread Size	PTT 30 Flare Thread Size	SAE Flare-less Thread Size	Seal-Lok Thread
2	1/8 - 27	5/16 - 24	5/16 - 24	5/16 - 24	-	-	5/16 - 24	-
3	-	3/8 - 24	3/8 - 24	3/8 - 24	-	-	3/8 - 24	-
4	1/4 - 18	7/16 - 20	7/16 - 20	7/16 - 20	7/16 - 24	-	7/16 - 20	9/16 - 18
5	-	1/2 - 20	1/2 - 20	1/2 - 20	1/2 - 20	-	1/2 - 20	-
6	3/8 - 18	9/16 - 18	5/8 - 18	9/16 - 18	5/8 - 18	-	9/16 - 18	11/16-16
8	1/2 - 14	3/4 - 16	3/4 - 16	3/4 - 16	3/4 - 18	-	3/4 - 16	13/16 - 16
10	-	7/8 - 14	7/8 - 14	7/8 - 14	7/8 - 18	-	7/8 - 14	1 - 14
12	3/4 - 14	1 1/16 - 12	1 1/16 - 14	1 1/16 - 12	-	-	1 1/16 - 12	1 3/16 - 12
14	-	1 3/16 - 12	-	1 3/16 - 12	-	-	1 3/16 - 12	-
16	1 - 11 1/2	1 5/16 - 12	-	1 5/16 - 12	-	1 5/16 - 14	1 5/16 - 12	1 7/16 - 12
20	1 1/4 - 11 1/2	1 5/8 - 12	-	1 5/8 - 12	-	1 5/8 - 14	1 5/8 - 12	1 11/16 - 12
24	1 1/2 - 11 1/2	1 7/8 - 12	-	1 7/8 - 12	-	1 7/8 - 14	1 7/8 - 12	2-12
32	2 - 11 1/2	2 1/2 - 12	-	2 1/2 - 12	-	2 1/2 - 12	2 1/2 - 12	-

									
Fitting Size	DIN "L" Swivel Female Thread Size	DIN "S" Swivel Female Thread Size	DIN "L" Male Stud Thread Size	DIN "S" Male Stud Thread Size	Male BSPP Thread Size	BSP Swive Female Thread Size	French Swivel Female Gaz Series	French Swivel Female Metric Series	French Male Stud Metric Series
4	-	-	-	-	1/4x19	1/4x19	--	-	-
6	M12x1,5	M14x1,5	M12x1,5	M14x1,5	3/8x19	3/8x19	-	-	M12x1
8	M14x1,5	M16x1,5	M14x1,5	M16x1,5	1/2x14	1/2x14	-	-	M14x1,5
10	M16x1,5	M18x1,5	M16x1,5	M18x1,5	5/8x14	5/8x14	-	-	M16x1,5
12	M18x1,5	M20x1,5	M18x1,5	M20x1,5	3/4x14	3/4x14	-	-	M18x1,5
-	-	-	-	-	-	-	M20x1,5	-	-
14	-	M22x1,5	-	M22x1,5	-	-	-	-	M20x1,5
15	M22x1,5	-	M22x1,5	-	-	-	-	-	M22x1,5
16	-	M24x1,5	-	M24x1,5	1x11	1x 11	-	-	M24x1,5
-	-	-	-	-	-	-	M24x1,5	-	-
18	M26x1,5	-	M26x1,5	-	-	-	-	-	M27x1,5
20	-	M30x2	-	M30x2	1 1/4x11	1 1/4x11	-	-	M27x1,5
-	-	-	-	-	-	-	M30x 1,5	-	-
22	M30x2	-	M30x2	-	-	-	-	-	M30x1,5
25	-	M36x2	-	M36x2	1 1/2x11	1 1/2x11	-	-	M33x1,5
-	-	-	-	-	-	-	M36x1,5	-	-
28	M36x2	-	M36x2	-	-	-	-	-	M36x1,5
30	-	M42x2	-	M42x2	2x11	2x11	-	-	M39x1,5
33	-	-	-	-	-	-	M45x1,5	-	-

A

B

C

D

E

# Application

# Standard Fitting Connections by Connection Type

A

B

C

D

E

	Description	End Code
Pipe	Male NPTF Pipe - Rigid - Straight	01
	Male NPTF Pipe - Swivel - Straight	13
	Male NPTF Pipe - Swivel - 90° Elbow	1L
	Male API Pipe - Rigid - Straight	AP
	Female NPTF Pipe - Rigid - Straight	02
	Female NPSM Pipe - Swivel - Straight (60° Cone)	07
	Female NPTF Pipe - Swivel - Straight	S2
	Female NPSM Pipe - Gasket Joint - Swivel - Straight	7G
	Female Grease Connection - SPL-PTF Taper Thread - Rigid Straight - 1/2 x 27	GJ
	Male NPTF Pipe - Rigid - 45° Elbow	31
Male NPTF Pipe - Rigid - 90° Elbow or Side Outlet	21	
SAE Str. Trd.	Male SAE Straight Thread with O-Ring - Rigid - Straight	05
	Male SAE Straight Thread with O-Ring - Swivel - Straight	0G
	Male SAE Straight Thread with O-Ring - Adjustable - 45° Elbow	25
	Male SAE Straight Thread with O-Ring - Swivel - 90° Elbow	0L
	Male SAE Straight Thread with O-Ring - Adjustable - 90° Elbow	35
Flare	Male JIC 37° - Rigid - Straight	03
	Male JIC 37° - Bulkhead without Locknut - Straight	LB
	Female JIC 37° - Swivel - Straight	06
	Female JIC 37° - Swivel - 45° Elbow - Short Drop	37
	Female JIC 37° - Swivel - 45° Elbow - Medium Drop	L7
	Female JIC 37° - Swivel - 90° Elbow - Short Drop	39
	Female JIC 37° - Swivel - 90° Elbow - Medium Drop	L9
	Female JIC 37° - Swivel - 90° Elbow - Long Drop	41
	Female JIC 37° - Swivel - Straight	48
	Female JIC 37° - Swivel - 150° Elbow	4V
	Male SAE 45° - Rigid - Straight	04
	Female SAE 45° - Swivel - Straight	08
	Female SAE 45 / Swivel - 45° Elbow	77
	Female SAE 45 / Swivel - 90° Elbow	79
	Female SAE 45 / Swivel - 90° Elbow - Long Drop	81
Female JIC 37°/SAE 45° Dual Flare - Swivel - Straight	68	
Inverted Flare	Male Inverted SAE 45° - Swivel - Straight	28
	Male Inverted SAE 45° - Swivel - 45° Elbow	67
	Male Inverted SAE 45° - Swivel - 90° Elbow	69
	Male Inverted SAE 45° - Swivel - 90° Elbow - Long (In-Line)	71
	Female Inverted SAE 45° - Rigid - Straight	29

	Description	End Code
Tube-O	Male Tube-O - Swivel - Straight - Short Pilot	S5
	Male Tube-O - Swivel - Straight - Long Pilot	45
	Male Tube-O - Swivel - Straight - Long Pilot with Low Pressure Charge Port for R134a	45-PT
	Female Tube-O - Swivel - 90° Elbow - Long Pilot	5L
	Female Tube-O - Swivel - 90° Elbow - Long Pilot with Low Pressure Charge Port for R134a	5L-PT
	Male Tube-O - Swivel - 90° Elbow - Long Pilot	5M
	Male Tube-O - Swivel - 90° Elbow - Long Pilot with Low Pressure Charge Port for R134a	5M-PT
	Male Tube-O - Swivel - 90° Elbow - Long Pilot with Low Pressure Charge Port for R134a	5M-PV
	Male Tube-O - Rigid - Straight - Internal Long Pilot (3-Step)	5G
	Male Tube-O - Swivel - 45° Elbow - Short Pilot	5R
	Male Tube-O - Swivel - 45° Elbow - Long Pilot	5P
	Male Tube-O - Swivel - 45° Elbow - Long Pilot with Low Pressure Charge Port for R134a	5P-PT
	Male Tube-O - Swivel - 90° Elbow - Short Pilot	5K
	Male Tube-O - Swivel - 90° Elbow - Short Pilot with High Pressure Charge Port for R134a	5K-PB
	Female Tube-O - Swivel - Straight - Short Pilot	5S
	Female Tube-O - Swivel - Straight - Long Pilot	59
	Female Tube-O - Swivel - Straight - Long Pilot with High Pressure Charge Port for 134a	59-PB
	Female Tube-O - Swivel - Straight - Long Pilot with Low Pressure Charge Port for R134a	59-PT
	Female Tube-O - Swivel - 45° Elbow - Short Pilot	5H
	Female Tube-O - Swivel - 45° Elbow - Long Pilot	5N
Female Tube-O - Swivel - 45° Elbow - Long Pilot with High Pressure Charge Port for R134a	5N-PB	
Female Tube-O - Swivel - 45° Elbow - Long Pilot with Low Pressure Charge Port for R134a	5N-PT	
Female Tube-O - Swivel - 90° Elbow - Short Pilot	5T	
Compressor	Female Compressor - Swivel - 45° Elbow	5V
	Female Compressor - Swivel - 90° Elbow	5W
	Female Compressor - Swivel - 90° Elbow - Block Type	5Z
	Female Compressor - Swivel - 135° Elbow	RV
	Female Compressor - Swivel - 180° Elbow - Block Type	RZ
Flange	Two Hole (2.25" X 0.44") Flange - Rigid - 90° Elbow	2H
	SAE Code 61 Flange Head - Straight	15
	SAE Code 61 Flange Head - Straight (5,000 psi)	4A
	SAE Code 61 Flange Head - 22½° Elbow -	16

Continued on next page

# Application

Continued from previous page

# Standard Fitting Connections by Connection Type

	Description	End Code
<b>Flange</b>	SAE Code 61 Flange Head-30° Elbow	26
	SAE Code 61 Flange Head-45° Elbow	17
	SAE Code 61 Flange Head-45° Elbow (5,000 psi)	4F
	SAE Code 61 Flange Head-60° Elbow	27
	SAE Code 61 Flange Head - 67½° Elbow	18
	SAE Code 61 Flange Head - 90° Elbow	19
	SAE Code 61 Flange Head - 90° Elbow - (5,000 psi)	4N
	SAE Code 61 Flange Head - 90° Elbow - Long Drop	89
	SAE Code 61 Flange Head - 110° Elbow	2U
	SAE Code 62 Flange Head - Straight	6A
	SAE Code 62 Flange Head - 22½° Elbow	6B
	SAE Code 62 Flange Head - 30° Elbow	6E
	SAE Code 62 Flange Head - 45° Elbow	6F
	SAE Code 62 Flange Head - 60° Elbow	6G
	SAE Code 62 Flange Head - 90° Elbow	6N
	Caterpillar® Flange Head - Straight	XA
	Caterpillar® Flange Head - 22½° Elbow	XB
	Caterpillar® Flange Head - 30° Elbow	XE
	Caterpillar® Flange Head - 45° Elbow	XF
	Caterpillar® Flange Head - 60° Elbow	XG
Caterpillar® Flange Head - 67½° Elbow	XM	
Caterpillar® Flange Head - 90° Elbow	XN	
<b>Seal-Lok</b>	Male Seal-Lok - Rigid - Straight (with O-Ring)	J0
	Male Seal-Lok - Bulkhead without Locknut - Straight (with O-Ring)	JB
	Female Seal-Lok - Swivel - Straight - Long	JS
	Female Seal-Lok - Swivel - Straight - Short	JC
	Female Seal-Lok - Swivel - 22½° Elbow	J6
	Female Seal-Lok - Swivel - 45° Elbow	J7
	Female Seal-Lok - Swivel - 90° Elbow - Short Drop	J9
	Female Seal-Lok - Swivel - 90° Elbow - Medium Drop	J5
	Female Seal-Lok - Swivel - 90° Elbow - Long Drop	J1
	<b>Metric</b>	Female Metric Swivel - Straight (30° Flare)
Female Metric - Swivel - Straight (30° Flare)		XU
Male Metric L - Rigid - Straight (24° Cone)		D0
Male Standpipe Metric L - Rigid - Straight		1D
Female Metric - Swivel - Straight (Ball Nose)		C0
Female Metric L - Swivel - Straight (Ball Nose)		C3
Female Metric L - Swivel - 45° Elbow (Ball Nose)		C4

	Description	End Code
<b>Metric</b>	Female Metric L - Swivel - 90° Elbow (Ball Nose)	C5
	Female Metric L - Swivel - Straight (24° Cone with O-Ring)	CA
	Female Metric L - Swivel - 45° Elbow (24° Cone with O-Ring)	CE
	Female Metric L - Swivel - 90° Elbow (24° Cone with O-Ring)	CF
	Male Metric S - Rigid - Straight (24° Cone)	D2
	Male Standpipe Metric S - Rigid - Straight	3D
	Female Metric S - Swivel - Straight (Ball Nose)	C6
	Female Metric S - Swivel - 45° Elbow (Ball Nose)	C7
	Female Metric S - Swivel - 90° Elbow (Ball Nose)	C8
	Female Metric S - Swivel - Straight (24° Cone with O-Ring)	C9
<b>BSP</b>	Female Metric S - Swivel - 45° Elbow (24° Cone with O-Ring)	0C
	Female Metric S - Swivel - 90° Elbow (24° Cone with O-Ring)	1C
	Male BSP Taper Pipe - Rigid - Straight	91
	Female BSP Parallel Pipe - Swivel - Straight (60° Cone)	92
	Male BSP Parallel Pipe - Rigid - Straight (60° Cone)	D9
	Female BSP Parallel Pipe - Swivel - 45° Elbow (60° Cone)	B1
	Female BSP Parallel Pipe - Swivel - 90° Elbow (60° Cone)	B2
	Female BSP Parallel Pipe - Swivel - 90° Elbow Block Type (60° Cone)	B4
	Female BSP Parallel Pipe - Swivel - Straight (Flat Seat)	B5
	Male BSP Taper Pipe - Rigid - 45° Elbow	BV
<b>Fr. Gaz</b>	Male BSP Taper Pipe - Rigid - 90° Elbow or Side Outlet	BZ
	Female BSP Parallel Pipe - Swivel - Straight (30° Flare)	FU
	Male BSP Taper Pipe - Rigid - Straight (60° Cone)	UT
	Female BSP Parallel Pipe - Swivel - Straight (60° Cone)	GU
	Female BSP Parallel Pipe - Swivel - 45° Elbow (60° Cone)	G1
	Female BSP Parallel Pipe - Swivel - 90° Elbow (60° Cone)	G2
	Male French Gaz Series - Rigid - Straight (24° Cone)	FG
	Female French Gaz Series - Swivel - Straight (Ball Nose)	F4
	DIN Metric Banjo - Straight	49
	88 Series Heavy Duty Hose Clamp (Double Bolt Hose Clamp)	88DB
<b>Specialty</b>	88 Series Hose Clamp- <i>SAE</i> 100R4 Two-Bolt Clamp	88HC-H
	88 Series Hose Clamp (Worm Gear)	88HC
	Push-Lok Union	82
	Hose Splicer	88
	Male Standpipe - Rigid - Straight (Inch Size Tube O.D.)	34
	Male Ferulok Flareless-Rigid-Straight (24° Cone with Nut and Ferrule)	11
	Female Ferulok Flareless - Swivel - Straight (24° Cone)	12
	Female Air Brake Jounce Line - Swivel - Straight	7B
	Male Refrigerant Tube Mender - Straight (with Nut and Ferrule)	T1
	Female PTT 30° - Swivel	32
Male <i>SAE</i> Compression Seat (without Nut or Sleeve)	61	

A

B

C

D

E

# Application

# Standard Fitting Connections by End Code

A

B

C

D

E

**Standard Fitting Configurations by Connection and End Code Listed in Numerical Order**

Description	End Code
Female Metric S - Swivel - 45° Elbow (24° Cone with O-Ring)	0C
Male SAE Straight Thread with O-Ring - Swivel - Straight	0G
Male SAE Straight Thread with O-Ring - Swivel - 90° Elbow	0L
Male NPTF Pipe - Rigid - Straight	01
Female Metric S - Swivel - 90° Elbow (24° Cone with O-Ring)	1C
Male Standpipe Metric L - Rigid - Straight	1D
Male NPTF Pipe - Swivel - 90° Elbow	1L
Female NPTF Pipe - Rigid - Straight	02
Two Hole (2.25" X 0.44") Flange - Rigid - 90° Elbow	2H
SAE Code 61 Flange Head - 110° Elbow	2U
Male JIC 37° - Rigid - Straight	03
Male Standpipe Metric S - Rigid - Straight	3D
Male SAE 45° - Rigid - Straight	04
SAE Code 61 Flange Head - Straight (5,000 psi)	4A
SAE Code 61 Flange Head-45° Elbow (5,000 psi)	4F
SAE Code 61 Flange Head - 90° Elbow - (5,000 psi)	4N
Female JIC 37° - Swivel - 150° Elbow	4V
Male SAE Straight Thread with O-Ring - Rigid - Straight	05
Male Tube-O - Rigid - Straight - Internal Long Pilot (3-Step)	5G
Female Tube-O - Swivel - 45° Elbow - Short Pilot	5H
Male Tube-O - Swivel - 90° Elbow - Short Pilot	5K
Male Tube-O - Swivel - 90° Elbow - Short Pilot with High Pressure Charge Port for R134a	5K-PB
Female Tube-O - Swivel - 90° Elbow - Long Pilot with Low Pressure Charge Port for R134a	5L-PT
Male Tube-O - Swivel - 90° Elbow - Long Pilot	5M
Male Tube-O - Swivel - 90° Elbow - Long Pilot with Low Pressure Charge Port for R134a	5M-PT
Male Tube-O - Swivel - 90° Elbow - Long Pilot with Low Pressure Charge Port for R134a	5M-PV
Female Tube-O - Swivel - 45° Elbow - Long Pilot	5N
Female Tube-O - Swivel - 45° Elbow - Long Pilot with High Pressure Charge Port for R134a	5N-PB
Female Tube-O - Swivel - 45° Elbow - Long Pilot with Low Pressure Charge Port for R134a	5N-PT
Male Tube-O - Swivel - 45° Elbow - Long Pilot	5P
Male Tube-O - Swivel - 45° Elbow - Long Pilot with Low Pressure Charge Port for R134a	5P-PT
Male Tube-O - Swivel - 45° Elbow - Short Pilot	5R
Female Tube-O - Swivel - Straight - Short Pilot	5S
Female Tube-O - Swivel - 90° Elbow - Short Pilot	5T

**Standard Fitting Configurations by Connection and End Code Listed in Numerical Order**

Description	End Code
Female Compressor - Swivel - 45° Elbow	5V
Female Compressor - Swivel - 90° Elbow	5W
Female Compressor - Swivel - 90° Elbow - Block Type	5Z
Female JIC 37° - Swivel - Straight	06
SAE Code 62 Flange Head - Straight	6A
SAE Code 62 Flange Head - 22½° Elbow	6B
SAE Code 62 Flange Head - 30° Elbow	6E
SAE Code 62 Flange Head - 45° Elbow	6F
SAE Code 62 Flange Head - 60° Elbow	6G
SAE Code 62 Flange Head - 90° Elbow	6N
Female NPSM Pipe - Swivel - Straight (60° Cone)	07
Female Air Brake Jounce Line - Swivel - Straight	7B
Female NPSM Pipe - Gasket Joint - Swivel - Straight	7G
Female SAE 45° - Swivel - Straight	08
Male Ferulok Flareless-Rigid-Straight (24° Cone with Nut and Ferrule)	11
Female Ferulok Flareless - Swivel - Straight (24° Cone)	12
Male NPTF Pipe - Swivel - Straight	13
SAE Code 61 Flange Head - Straight	15
SAE Code 61 Flange Head - 22½° Elbow -	16
SAE Code 61 Flange Head-45° Elbow	17
SAE Code 61 Flange Head - 67½° Elbow	18
SAE Code 61 Flange Head - 90° Elbow	19
Male NPTF Pipe - Rigid - 90° Elbow or Side Outlet	21
Male SAE Straight Thread with O-Ring - Adjustable - 45° Elbow	25
SAE Code 61 Flange Head-30° Elbow	26
SAE Code 61 Flange Head-60° Elbow	27
Male Inverted SAE 45° - Swivel - Straight	28
Female Inverted SAE 45° - Rigid - Straight	29
Male NPTF Pipe - Rigid - 45° Elbow	31
Female PTT 30° - Swivel	32
Male Standpipe - Rigid - Straight (Inch Size Tube O.D.)	34
Male SAE Straight Thread with O-Ring - Adjustable - 90° Elbow	35
Female JIC 37° - Swivel - 45° Elbow - Short Drop	37
Female JIC 37° - Swivel - 90° Elbow - Short Drop	39
Female JIC 37° - Swivel - 90° Elbow - Long Drop	41
Male Tube-O - Swivel - Straight - Long Pilot	45
Male Tube-O - Swivel - Straight - Long Pilot with Low Pressure Charge Port for R134a	45-PT
Female JIC 37° - Swivel - Straight	48

Continued on next page



# Application

Continued from previous page

# Standard Fitting Connections by End Code

Description	End Code
DIN Metric Banjo - Straight	49
Female Tube-O - Swivel - Straight - Long Pilot	59
Female Tube-O - Swivel - Straight - Long Pilot with Charge Port for 134a	59-PB
Female Tube-O - Swivel - Straight - Long Pilot with Charge Port	59-PT
Male SAE Compression Seat (without Nut or Sleeve)	61
Male Inverted SAE 45° - Swivel - 45° Elbow	67
Female JIC 37°/SAE 45° Dual Flare - Swivel - Straight	68
Male Inverted SAE 45° - Swivel - 90° Elbow	69
Male Inverted SAE 45° - Swivel - 90° Elbow - Long (In-Line)	71
Female SAE 45 / Swivel - 45° Elbow	77
Female SAE 45 / Swivel - 90° Elbow	79
Female SAE 45 / Swivel - 90° Elbow - Long Drop	81
Push-Lok Union	82
Hose Splicer	88
88 Series Heavy Duty Hose Clamp (Double Bolt Hose Clamp)	88DB
88 Series Hose Clamp (Worm Gear)	88HC
88 Series Hose Clamp- <i>SAE 100R4 Two-Bolt Clamp</i>	88HC-H
SAE Code 61 Flange Head - 90° Elbow - Long Drop	89
Male BSP Taper Pipe - Rigid - Straight	91
Female BSP Parallel Pipe - Swivel - Straight (60° Cone)	92
Male API Pipe - Rigid - Straight	AP
Female BSP Parallel Pipe - Swivel - 45° Elbow (60° Cone)	B1
Female BSP Parallel Pipe - Swivel - 90° Elbow (60° Cone)	B2
Female BSP Parallel Pipe - Swivel - 90° Elbow Block Type (60° Cone)	B4
Female BSP Parallel Pipe - Swivel - Straight (Flat Seat)	B5
Male BSP Taper Pipe - Rigid - 45° Elbow	BV
Male BSP Taper Pipe - Rigid - 90° Elbow or Side Outlet	BZ
Female Metric - Swivel - Straight (Ball Nose)	C0
Female Metric L - Swivel - Straight (Ball Nose)	C3
Female Metric L - Swivel - 45° Elbow (Ball Nose)	C4
Female Metric L - Swivel - 90° Elbow (Ball Nose)	C5
Female Metric S - Swivel - Straight (Ball Nose)	C6
Female Metric S - Swivel - 45° Elbow (Ball Nose)	C7
Female Metric S - Swivel - 90° Elbow (Ball Nose)	C8
Female Metric S - Swivel - Straight (24° Cone with O-Ring)	C9
Female Metric L - Swivel - Straight (24° Cone with O-Ring)	CA
Female Metric L - Swivel - 45° Elbow (24° Cone with O-Ring) -	CE
Female Metric L - Swivel - 90° Elbow (24° Cone with O-Ring) -	CF
Male Metric L - Rigid - Straight (24° Cone)	D0
Male Metric S - Rigid - Straight (24° Cone)	D2
Male BSP Parallel Pipe - Rigid - Straight (60° Cone)	D9
Female French Gaz Series - Swivel - Straight (Ball Nose)	F4

Standard Fitting Configurations by Connection and End Code Listed in Numerical Order

Description	End Code
Male French Gaz Series - Rigid - Straight (24° Cone)	FG
Female BSP Parallel Pipe - Swivel - Straight (30° Flare)	FU
Female BSP Parallel Pipe - Swivel - 45° Elbow (60° Cone)	G1
Female BSP Parallel Pipe - Swivel - 90° Elbow (60° Cone)	G2
Female Grease Connection - SPL-PTF Taper Thread - Rigid Straight - 1/2 x 27	GJ
Female BSP Parallel Pipe - Swivel - Straight (60° Cone)	GU
Male Seal-Lok - Rigid - Straight (with O-Ring)	J0
Female Seal-Lok - Swivel - 90° Elbow - Long Drop	J1
Female Seal-Lok - Swivel - 90° Elbow - Medium Drop	J5
Female Seal-Lok - Swivel - 221/2° Elbow	J6
Female Seal-Lok - Swivel - 45° Elbow	J7
Female Seal-Lok - Swivel - 90° Elbow - Short Drop	J9
Male Seal-Lok - Bulkhead without Locknut - Straight	JB
Female Seal-Lok - Swivel - Straight - Short	JC
Female Seal-Lok - Swivel - Straight - Long	JS
Female JIC 37° - Swivel - 45° Elbow - Medium Drop	L7
Female JIC 37° - Swivel - 90° Elbow - Medium Drop	L9
Male JIC 37° - Bulkhead without Locknut - Straight	LB
Female Metric Swivel - Straight (30° Flare)	MU
Female Compressor - Swivel - 135° Elbow	RV
Female Compressor - Swivel - 180° Elbow - Block Type	RZ
Female NPTF Pipe - Swivel - Straight	S2
Male Tube-O - Swivel - Straight - Short Pilot	S5
Male Tube-O - Swivel - Straight - Short Pilot with Charge Port for R12	S5-PR
Male Refrigerant Tube Mender - Straight (with Nut and Ferrule)	T1
Male BSP Taper Pipe - Rigid - Straight (60° Cone)	UT
Caterpillar® Flange Head - Straight	XA
Caterpillar® Flange Head - 22 1/2° Elbow	XB
Caterpillar® Flange Head - 30° Elbow	XE
Caterpillar® Flange Head - 45° Elbow	XF
Caterpillar® Flange Head - 60° Elbow	XG
Caterpillar® Flange Head - 67 1/2° Elbow	XM
Caterpillar® Flange Head - 90° Elbow (with O-Ring)	XN
Female Metric - Swivel - Straight (30° Flare)	XU

Standard Fitting Configurations by Connection and End Code Listed in Numerical Order

A

B

C

D

E

# Application

# Metric Conversion

## METRIC to ENGLISH EQUIVALENTS ENGLISH to METRIC EQUIVALENTS

inches x 25.4 = millimeters (mm)  
 inches x 2.54 = centimeters (cm)  
 feet x .3048 = meters (m)  
 yard x .9144 = meters (m)  
 psi x .0689 = bar  
 psi x .0069 = Megapascals (MPa)  
 psi x .0703 = Kilogram force per square centimeter (Kgf/cm<sup>2</sup>)  
 pound force x 4.448 = Newtons  
 pound · inch x .113 = Newton · meters (N · m)  
 pound · foot x 1.356 = Newton · meters (N · m)  
 millimeter x .0394 = inch (in)  
 centimeter x .3937 = inch (in)  
 meters x 3.281 = feet (ft)  
 meters x 1.0936 = yards (yd)  
 bar x 14.5 = psi  
 Megapascals x 145.0 = psi  
 Kilogram force per square centimeter x 14.22 = psi  
 Newtons x .2248 = pounds force (lbf)  
 Newton · meter x 8.850 = pound · inches (lb · in)  
 Newton · meter x .737 = pound feet (lb · ft)

## METRIC I.D. KIT

### INTERNATIONAL HOSE FITTING IDENTIFICATION KIT

The booklet, gauges and caliper contained in this fitting I.D. Kit, can be used to identify most types of hydraulic hose fittings and adapters including:

- U.S. Standards
- British Standard Pipe
- German (DIN) Metric
- French Metric and GAZ
- Japanese Standards (JIS)

Contents of Kit:

- Instruction Book with Tables
- Screw Pitch Gauge for U.S. Threads
- International Gauge for Metric and British Threads
- Inch and Millimeter Caliper
- Carry Case

## MILLIMETERS to FRACTIONS to DECIMALS

MM	INCHES		MM	INCHES		MM	INCHES		MM	INCHES	
	FRACTION	DECIMAL		FRACTION	DECIMAL		FRACTION	DECIMAL		FRACTION	DECIMAL
0.3969	1/64	0.0156	6.7469	17/64	0.2656	13.0969	33/64	0.5156	19.4469	49/64	0.7656
0.7938	1/32	0.0312	7.1438	9/32	0.2812	13.4938	17/32	0.5312	19.8438	25/32	0.7812
1.1906	3/64	0.0468	7.5406	19/64	0.2968	13.8906	35/64	0.5468	20.2406	51/64	0.7968
1.5875	1/16	0.0625	7.9375	5/16	0.3125	14.2875	9/16	0.5625	20.2375	13/16	0.8125
1.9844	5/64	0.0781	8.3344	21/64	0.3281	14.6844	37/64	0.5781	21.0344	53/64	0.8281
2.3812	3/32	0.0937	8.7312	11/32	0.3437	15.0812	19/32	0.5937	21.4312	27/32	0.8437
2.7781	7/64	0.1093	9.1281	23/64	0.3593	15.4781	39/64	0.6093	21.8281	55/64	0.8593
3.1750	1/8	0.1250	9.5250	3/8	0.3750	15.8750	5/8	0.6250	22.2250	7/8	0.8750
3.5719	9/64	0.1406	9.9219	25/64	0.3906	16.2719	41/64	0.6406	22.6219	57/64	0.8906
3.9688	5/32	0.1562	10.3188	13/32	0.4062	16.6688	21/32	0.6562	23.0188	29/32	0.9062
4.3656	11/64	0.1718	10.7156	27/64	0.4218	17.0656	43/64	0.6718	23.4156	59/64	0.9218
4.7625	3/16	0.1875	11.1125	7/16	0.4375	17.4625	11/16	0.6875	23.8125	15/16	0.9375
5.1594	13/64	0.2031	11.5094	29/64	0.4531	17.8594	45/64	0.7031	24.2094	61/64	0.9531
5.5562	7/32	0.2187	11.9062	15/32	0.4687	18.2562	23/32	0.7187	24.6062	31/32	0.9687
5.9531	15/64	0.2343	12.3031	31/64	0.4843	18.6531	47/64	0.7343	25.0031	63/64	0.9843
6.3500	1/4	0.2500	12.7000	1/2	0.5000	19.0500	3/4	0.7500	25.4000	1	1.0000

## Media

## Chemical Resistance Information

**Warning:** This chemical compatibility guide must not be used in conjunction with any other compatibility guides from previous or future catalog editions, bulletins or publications. Incorrect use of these charts could result in death, personal injury or property damage.

## Hose Selection by Medium and Hose Type

This hose compatibility chart is a ready reference of Parker hose compatibility with various fluid media. It is intended as a guide to chemical compatibility with inner tube materials and assembly lubricant applied internally. The specific recommendations are based upon field experience, the advice of various polymer or fluid suppliers, and specific laboratory experiments. **It must be stressed, however, that this information is offered only as a guide.** Final hose selection depends also upon pressure, fluid temperature, ambient temperature, and special requirements or variations, which may not be known by Parker Hannifin. Legal and other regulations must be followed with particular care. Where an external compatibility problem may occur, or for fluids not listed, we encourage you to first contact the fluid manufacturer for a recommendation prior to contacting your Parker Hannifin Field Representative or the Technical Service Department, Hose Products Division, Wickliffe, Ohio.

## Use the Chart as Follows:

1. Locate medium to be carried using the Chemical Resistance Table on the following pages.
2. Select suitability of hose and fitting material from the table based on the letter rating in the table. See resistance rating key below for explanation of compatibility ratings. See list of numerals below for an explanation when a numeral, or a numeral and a letter rating are present in the table.
3. The Column headings on the Chemical Resistance Table, I, II, III, IV, V, refer to specific groups of hoses.
4. Locate hose part number under Column I, II, III, IV, V from the list below.
5. For fitting material availability refer to appropriate fitting section of catalog.
6. Check hose specifications in this catalog. Contact Hose Division Technical Service Department on any items not cataloged.

## Resistance Rating Key

A = Preferred, good to excellent with little or no change in physical properties.

F = Fair, marginal or conditional with noticeable affects on physical properties.

X = Unsuitable, severe affects on physical properties.

~ = No rating, insufficient information.

Note: All data based on 70°F unless otherwise noted.

## Numerals

1. For air or gaseous applications above 250 PSI (1,7 MPa), the cover should be pin pricked. The service life for air or gaseous applications can be unpredictable, especially at higher pressures. Contact Technical Service Department for more information.
2. Legal and insurance regulations must be considered. Contact Technical Service Department for more information.
3. Push-Lok hoses 801 and 836 are approved for diesel fuel applications only when coupled with HY series fittings.
4. Use 285, 235 or 244 hoses. The compatibility of the systems refrigeration oil with these hoses needs to be evaluated on a case by case basis. Contact HPD Technical Service Department for more information. Do not use mineral oil or Alkyl Benzene refrigeration oils with 244 hose. Chemical compatibility does not imply low permeation.
5. 150°F (65°C) maximum.
6. Satisfactory at some concentrations and temperatures, unsatisfactory at others.
7. For Phosphate Ester and Skydrol fluids, be aware a certain amount of permeation will occur. The rate and amount will depend on the fluid type, any blends or additives to the fluid, and the system operating parameters.
8. Acceptable for flushing hose assemblies.
9. 221FR hose recommended.
10. For dry air applications, hoses with inner tubes from columns IV, and V are preferred. See hose specifications for maximum recommended temperatures with air.
11. Use SS23CG or SS25UL
12. Use SS23CG

## Hose Types

## Column I

201, 601, 881

## Column II

SS25UL, 421WC, 471TC, 471ST, 472LT, 722LT, 792LT, 801, 811, 811HT

## Column III

JK, 187/TC/ST, 221FR, 302, 387/TC/ST, 422, 472TC, 482TC, 482ST, 487/TC/ST, 722/TC/ST, 787/TC/ST, 797/TC/ST, 821

## Column IV

206, 213, 266, 293, 426, 611HT, 821FR, 836, 436

## Column V

F42, 304, 424, 774, 804

**Caution:**

The fluid manufacturer's recommended maximum operating temperature for any specific name-brand fluid should be closely observed by the user. Specific name brand fluids can vary greatly between manufacturers even though they are considered to be from the same family or type of fluids. Using fluids above the manufacturers maximum recommended temperature can cause the fluid to break down, creating by-products that can be harmful to elastomers or other materials used in the system. When selecting a hose type, both the fluid manufacturer and hose manufacturers maximum temperature limit must be taken into consideration, with the lower of the two taking precedence.

A

B

C

D

E

# Media

# Chemical Resistance Information (Page 1 of 9)

**Warning:** This chemical compatibility guide must not be used in conjunction with any other compatibility guides from previous or future catalog editions, bulletins or publications. Incorrect use of these charts could result in death, personal injury or property damage.

MEDIA	I	II	III	IV	V	Steel	Brass	SS
3M FC-75	A	A	A	A	A	A	A	A
Acetic Acid	X	X	X	A	6	X	X	A
Acetone	X	X	X	A	A	A	A	A
Acetylene	X	X	X	X	X	~	~	~
Aeroshell 31	F	A	A	F	~	A	A	A
AEROSHELL Turbine Oil 500	X	X	F	X	X	A	A	A
Air	A,1,10	A,1,10	A,1,10	A,1,10	A,1,10	A	A	A
Air (dry)	X	X	X	A,1,10	A,1,10	A	A	A
Alcohol (Methanol-Ethanol)	F	F	F	F	F	F	A	A
Americas Choice AW ISO 46	~	F	F	~	~	~	~	~
Ammonia (Anhydrous)	X	X	X	X	X	X	X	X
Ammonium Chloride	A	A	A	A	A	X	X	X
Ammonium Hydroxide	F	F	F	A	A	F	X	A
Ammonium Nitrate	A	A	A	F	A	F	X	A
Ammonium Phosphate	A	A	A	A	A	X	X	F
Ammonium Sulfate	A	A	A	A	A	F	X	F
Amoco 32 Rykon	X	A	A	F	X	A	A	A
Ampol PE 46	X	X	X	X	A,7	A	A	A
AMSOIL Synthetic ATF	F	A	A	A	X	A	A	A
Amyl Alcohol	X	X	X	F	F	X	A	A
Anderol 495,497,500,750	X	X	X	F	X	A	A	A
Aniline	X	X	X	F	A	A	X	A
Animal Fats	X	F	F	F	F	6	6	A
Aquacent Light, Heavy	X	A	A	X	X	A	A	A
Aries/Athena	F	F	F	~	X	A	A	A
Aromatic 100,150	X	F	F	~	X	A	A	A
Arrow 602P	A	A	A	A	X	A	A	A
Asphalt	X	F	F	F	X	F	F	A
ASTM #3 Oil	F	F	F	F	X	A	A	A
Astrol 1044AW	A	A	A	~	X	A	A	A
ATF-M	F	A	A	A	X	A	A	A
Automotive Brake Fluid	X	X	X	X	~	X	X	X
AW 32,46,68	F	A	A	A	X	A	A	A
BCF	F	F	F	F	~	A	A	A
Benz Petraulic 32,46,68,100,150,220,320,460	F	A	A	A	X	A	A	A
Benzene, Benzol	X	X	X	F	X	A	A	A
Benzgrind HP 15	~	A	A	A	X	A	A	A
Benzine	X	X	X	F	X	A	A	A
Bio Diesel B20	~	A	A	A	X	A	A	A
Bio-Soy, Agri Industries	X	A	A	X	X	A	A	A
Biodegradable Hydraulic Fluid 112B	X	A	A	X	~	A	A	A
Borax	F	F	F	F	A	F	A	A
Boric Acid	A	A	A	X	A	X	6	A
Brayco 882	X	A	A	A	X	A	A	A

## Media

# Chemical Resistance Information

(Page 2 of 9)

**Warning:** This chemical compatibility guide must not be used in conjunction with any other compatibility guides from previous or future catalog editions, bulletins or publications. Incorrect use of these charts could result in death, personal injury or property damage.

MEDIA	I	II	III	IV	V	Steel	Brass	SS
Brayco Micronic 745	~	A	A	F	X	A	A	A
Brayco Micronic 776RP	F	A	A	F	X	A	A	A
Brayco Micronic 889	X	F	F	~	X	A	A	A
Brine	F	F	F	A	A	X	F	F
Butane			See numerals 2 and 11			A	A	A
Butyl Alcohol, Butanol	F	F	F	F	F	F	F	A
Calcium Chloride	A	A	A	F	A	F	F	X
Calcium Hydroxide	A	A	A	A	A	A	A	A
Calcium Hypochlorite	X	X	X	A	A	X	F	X
Calibrating Fluid	A	A	A	A	X	A	A	A
Carbon Dioxide, gas	F	F	F	F	6	A	A	A
Carbon Dioxide, liquid	X	X	X	X	X	X	X	X
Carbon Disulfide	X	X	X	F	X	A	F	A
Carbon Monoxide (hot)	F	F	F	F	6	F	6	A
Carbon Tetrachloride	X	X	X	F	X	6	6	6
Carbonic Acid	F	F	F	X	F	X	X	F
Castor Oil	A	A	A	A	A	A	A	A
Castrol 5000	X	F	F	A	X	A	A	A
Cellosolve Acetate	X	X	X	X	A	X	X	A
Cellugard	A	A	A	~	A	A	A	A
Cellulube 90, 150, 220 300, 550, 1000	X	X	X	~	A	A	A	A
Chevron Clarity AW 32, 46, 68	A	A	A	A	X	A	A	A
Chevron FLO-COOL 180	F	F	F	~	X	A	A	A
Chevron FR-8, 10, 13, 20	X	X	X	X	A,7	A	A	A
Chevron Hydraulic Oils AW MV 15, 32, 46, 68, 100	A	A	A	A	X	A	A	A
Chevron HyJet IV (9)	X	X	X	X	A,7	A	A	A
Chevron Rykon MV	F	A	A	~	~	A	A	A
Cindol 3204 PBR	~	A	A	A	X	A	A	A
Citric Acid	F	A	A	X	A	X	X	6
Commonwealth EDM 242, 244	A	A	A	~	X	A	A	A
CompAir CN300	X	X	X	F	X	A	A	A
CompAir CS100, 200, 300, 400	X	X	X	F	X	A	A	A
Coolanol 15, 20, 25, 35, 45	A	A	A	A	A	A	A	A
Copper Chloride	F	A	A	X	A	X	X	X
Copper Sulfate	A	A	A	X	A	X	X	F
Cosmolubric HF-122, HF-130, HF-144	X	F	A	X	X	A	A	A
Cosmolubric HF-1530	X	F	A	X	X	A	A	A
Cottonseed Oil	F	A	A	F	X	A	A	A
CPI CP-4000	X	X	X	F	X	A	A	A
Crude Petroleum Oil	F	A	A	A	X	F	F	A
CSS 1001Dairy Hydraulic Fluid	F	A	A	A	X	A	A	A
Daphne AW32	A	A	A	A	X	A	A	A
Dasco FR 201-A	A	A	A	~	X	A	A	A
Dasco FR150, 200, 310	F	A	A	~	A	A	A	A
Dasco FR300, FR2550	X	X	X	~	X	A	A	A

A

B

C

D

E

# Media

# Chemical Resistance Information (Page 3 of 9)

**Warning:** This chemical compatibility guide must not be used in conjunction with any other compatibility guides from previous or future catalog editions, bulletins or publications. Incorrect use of these charts could result in death, personal injury or property damage.

MEDIA	I	II	III	IV	V	Steel	Brass	SS
Dasco FR355-3	X	F	A	X	X	A	A	A
Deicer Fluid 419R	A	A	A	~	~	A	A	A
Deionized Water	A	A	A	A	A	F	F	A
Dexron II ATF	F	A	A	A	X	A	A	A
Dexron III ATF (to 170°F)	A	A	A	A	X	A	A	A
Dexron III ATF (to 212°F)	X	F	F	A	X	A	A	A
Dexron III ATF (to 250°F)	X	X	X	F	X	A	A	A
Dexron III ATF (to 300°F)	X	X	X	X	X			
Dexron VI ATF (to 170°F)	A	A	A	A	X	A	A	A
Dexron VI ATF (to 212°F)	X	F	F	A	X	A	A	A
Dexron VI ATF (to 250°F)	X	X	X	X	X	A	A	A
Dexron VI ATF (to 300°F)	X	X	X	X	X			
DexronIIIE/Mercon (at 212°F)	X	A	A	A	X	A	A	A
Diesel Fuel (Standard and Ultra Low Sulfur)	F,3	A,3	A,3	A,3	X	A	A	A
Diester Fluids	X	X	X	F	X	A	A	A
Dow Corning 2-1802 Sullair (24KT)	~	~	~	F	~	A	A	A
Dow Corning DC 200, 510, 550, 560, FC126	A	A	A	F	~	A	A	A
Dow HD50-4	F	F	F	~	~	~	~	A
Dow Sullube 32	~	~	~	F	~	A	A	A
Dowtherm A,E	X	X	X	F	X	A	A	A
Dowtherm G	X	X	X	X	X	A	A	A
Duro AW-16, 31	A	A	A	~	X	A	A	A
Duro FR-HD	A	A	A	~	X	A	A	A
EcoSafe FR-68	A	A	A	~	~	A	A	A
Envirologic 3032, 3046, 3068	A	A	A	~	~	~	~	~
Ethanol	F	F	F	F	F	F	A	A
Ethers	X	X	X	F	X	A	A	A
Ethyl Acetate	X	X	X	F	F	F	A	A
Ethyl Alcohol	F	F	F	F	F	F	A	A
Ethyl Cellulose	F	F	F	F	F	X	F	F
Ethyl Chloride	X	X	X	X	A	F	F	F
Ethylene Dichloride	X	X	X	F	X	X	A	X
Ethylene Glycol	F	A	A	A	A	A	F	A
Exxon 2380 Turbo Oil	X	F	F	X	X	A	A	A
Exxon 3110 FR	A	A	A	A	X	A	A	A
Exxon Esstic	A	A	A	A	A	A	A	A
Exxon Mobil Rarus SHC 1026	~	~	~	A	~	A	A	A
Exxon Nuto H 46, 68	A	A	A	A	X	A	A	A
Exxon Tellura Industrial Process Oils	A	A	A	A	X	A	A	A
Exxon Terresstic, EP	A	A	A	A	A	A	A	A
Exxon Turbo Oil 2380	X	F	F	F	X	A	A	A
Exxon Univolt 60, N61	F	A	A	A	X	A	A	A
FE 232 (Halon)	X	X	X	X	F	A	A	A

## Media

# Chemical Resistance Information

(Page 4 of 9)

**Warning:** This chemical compatibility guide must not be used in conjunction with any other compatibility guides from previous or future catalog editions, bulletins or publications. Incorrect use of these charts could result in death, personal injury or property damage.

MEDIA	I	II	III	IV	V	Steel	Brass	SS
Fenso 150	~	A	A	~	X	A	A	A
Formaldehyde	X	X	X	A	A	X	F	A
Formic Acid	X	X	X	X	A	X	6	X
Freons see refrigerants	~	~	~	~	~	~	~	~
Fuel Oil	F	A	A	A	X	A	A	A
Fyre-Safe 120C, 126, 155, 1090E, 1150, 1220, 1300E	X	X	X	X	A,7	A	A	A
Fyre-Safe 200C, 225, 211	F	A	A	A	A	A	A	A
Fyre-Safe W/O	A	A	A	A	X	A	A	A
Fyrguard 150, 150-M, 200	A	A	A	A	A	A	A	A
Fyrquel 60, 90, 150, 220, 300, 550, 1000	X	X	X	X	A,7	A	A	A
Fyrquel EHC, GT, LT, VPF	X	X	X	X	A,7	A	A	A
Fyrtek MF, 215, 290, 295	X	X	X	X	X	A	A	A
Gardner-Denver GD5000, GD8000	X	X	X	F	X	A	A	A
Gasoline			See numeral 9			A	A	A
Glue	F	F	F	~	X	A	F	A
Glycerine, Glycerol	A	A	A	A	A	A	F	A
Grease	A	A	A	A	X	A	A	A
Green Plus ES	X	A	A	X	~	A	A	A
Greens Care 32, 46	F	A	A	F	~	A	A	A
Gulf-FR Fluid P37, P40, P43, P45, P47	X	X	X	F	A	A	A	A
H-515 (NATO)	A	A	A	~	X	A	A	A
Halon 1211, 1301	F	F	F	F	~	A	A	A
Helium Gas	X	X	X	X	X	A	A	A
Heptane	X	F	F	A	X	A	A	A
Hexane	X	F	F	A	X	A	A	A
HF-20, HF-28	~	A	A	A	A	A	A	A
Houghto-Safe 1055, 1110, 1115, 1120, 1130 (9)	X	X	X	X	A,7	A	A	A
Houghto-Safe 271 to 640	F	A	A	F	A	A	A	A
Houghto-Safe 419 Hydraulic Fluid	A	A	A	~	X	A	A	A
Houghto-Safe 419R Deicer Fluid	A	A	A	~	~	A	A	A
Houghto-Safe 5046, 5046W, 5047-F	A	A	A	A	X	A	A	A
HP 100C (Jack hammer oil)	F	A	A	A	X	A	A	A
HPWG 46B	F	A	A	F	~	A	A	A
Hul-E-Mul	A	A	A	~	X	A	A	A
Hychem C, EP1000, RDF	A	A	A	A	A	A	A	A
Hydra Safe E-190	A	A	A	F	X	A	A	A
Hydra-Cut 481, 496	A	A	A	~	X	A	A	A
Hydrafluid 760	A	A	A	~	X	A	A	A
Hydrochloric Acid	X	X	X	X	X	X	X	X
Hydrofluoric Acid	X	X	X	X	X	X	6	X
Hydrogen Gas	X	X	X	X	X	A	A	A
Hydrogen Peroxide	X	X	X	F	X	X	X	6
Hydrogen Sulfide	X	X	X	X	A	X	X	6
Hydrolube	A	A	A	F	A	A	A	A

A

B

C

D

E

## Media

# Chemical Resistance Information

(Page 5 of 9)

**Warning:** This chemical compatibility guide must not be used in conjunction with any other compatibility guides from previous or future catalog editions, bulletins or publications. Incorrect use of these charts could result in death, personal injury or property damage.

MEDIA	I	II	III	IV	V	Steel	Brass	SS
Hydrolubric 120-B, 141, 595	F	A	A	F	A	A	A	A
Hydrosafe Glycol 200	A	A	A	A	A	A	F	A
HyJet IV	X	X	X	X	A,7	A	A	A
Hyspin SP 10	~	A	A	A	~	A	A	A
Ideal Yellow 77	A	A	A	A	X	A	A	A
Imol S150 to S550	X	X	X	~	~	A	A	A
Ingersoll Rand SSR Coolant	X	X	X	F	X	A	A	A
Isocyanates	F	F	F	F	X	A	~	A
Isooctane	X	F	F	A	X	A	A	A
Isopar H	X	X	X	X	X	A	A	A
Isopropyl Alcohol	F	F	F	F	F	F	A	A
Jayflex DIDP	X	X	X	X	A	A	A	A
JP3 and JP4	X	A,3	A,3	~	X	A	A	A
JP5	X	A,3	A,3	F,3	X	A	A	A
JP9	X	X	X	X	X	A	~	A
Kaeser 150P, 175P, 325R, 687R	X	X	X	F	X	A	A	A
Kerosene	X	A	A	F	X	A	A	A
KSL-214, 219, 220, 222	X	X	X	F	X	A	A	A
Lacquer	X	X	X	F	X	X	A	A
Lacquer Solvents	X	X	X	F	X	X	A	A
Lactic Acids	X	X	X	X	X	X	X	A
Lindol HF	X	X	X	F	A	A	A	A
Linseed Oil	A	A	A	A	A	A	A	A
LP-Gas			See numeral 11			A	A	A
Magnesium Chloride	A	A	A	A	A	X	X	X
Magnesium Hydroxide	F	F	F	A	A	F	F	F
Magnesium Sulfate	A	A	A	A	A	A	F	A
Mercaptans	X	X	X	X	X	~	~	~
Methane			See numeral 12			A	A	A
Methanol	F	F	F	F	F	F	A	A
Methyl Alcohol	F	F	F	F	F	F	A	A
Methyl Chloride	X	X	X	F	X	A	A	A
Methyl Ethyl Ketone (MEK)	X	X	X	F	X	F	A	A
Methyl Isopropyl-Ketone	X	X	X	X	X	F	A	A
Metsafe FR303-M, FR303	X	X	X	X	X	A	A	A
Metsafe FR310, FR315, FR330, FR350	X	X	X	X	F, 7	A	A	A
Microzol-T46	X	A	A	~	X	A	A	A
MIL-B-46176A	X	X	X	X	X	X	X	X
MIL-H-46170	X	F	F	F	X	A	A	A
MIL-H-5606	F	A	A	A	X	A	A	A
MIL-H-6083	F	A	A	A	X	A	A	A
MIL-H-7083	F	A	A	A	X	A	A	A
MIL-H-83282	F	A	A	A	X	A	A	A
MIL-L-2104, 2104B	F	A	A	A	X	A	A	A



## Media

# Chemical Resistance Information

 (Page 6 of 9)

**Warning:** This chemical compatibility guide must not be used in conjunction with any other compatibility guides from previous or future catalog editions, bulletins or publications. Incorrect use of these charts could result in death, personal injury or property damage.

MEDIA	I	II	III	IV	V	Steel	Brass	SS
MIL-L-23699	X	X	X	X	X	A	A	A
MIL-L-7808	F	A	A	~	X	A	A	A
Mine Guard FR	A	A	A	~	A	A	A	A
Mineral Oil	A	A	A	F	X	A	A	A
Mineral Spirits	8	8	8	8	X	A	A	A
Mobil Aero HFE	F	A	A	F	X	A	A	A
Mobil DTE 11M, 13M, 15M, 16M, 18M, 19M	F	A	A	A	X	A	A	A
Mobil DTE 22, 24, 25, 26	F	A	A	A	X	A	A	A
Mobil EAL 224H	X	A	A	X	~	A	A	A
Mobil EAL Artic 10, 15, 22,32, 46, 68, 100	X	X	X	X	X	A	A	A
Mobil EAL Evirosyn 46	A	A	A	A	X	A	A	A
Mobil Glygoyle 11, 22, 30, 80	A	A	A	~	X	A	A	A
Mobil HFA	F	A	A	A	X	A	A	A
Mobil Jet 2	X	F	F	A	X	A	A	A
Mobil Nyvac 20, 30, 200, FR	F	A	A	F	A	A	A	A
Mobil Rarus 824, 826, 827	X	X	X	F	X	A	A	A
Mobil SHC 500 Series	A	A	A	A	X	A	A	A
Mobil SHC 600 Series	F	A	A	A	X	A	A	A
Mobil SHC 800 Series	F	A	A	A	X	A	A	A
Mobil SHL 624	~	A	A	A	X	A	A	A
Mobil Vactra Oil	A	A	A	F	X	A	A	A
Mobil XRL 1618B	X	X	X	X	A,7	A	A	A
Mobilfluid 423	F	A	A	A	X	A	A	A
Mobilgear SHC 150, 220, 320, 460, 680	F	F	F	F	X	A	A	A
Mobilrama 525	A	A	A	F	X	A	A	A
Molub-Alloy 890	X	X	X	F	X	A	A	A
Moly Lube 'HF' 902	F	F	F	F	X	A	A	A
Monolec 6120 Hydraulic Oil	A	A	A	A	X	A	A	A
Morpholine (pure additive)	X	X	X	X	X	X	X	A
Naptha	X	F	F	A	X	A	A	A
Napthalene	X	X	X	F	X	A	A	A
Natural Gas			See numeral 12			A	A	A
Nitric Acid	X	X	X	X	X	X	X	F
Nitrobenzene	X	X	X	F	X	X	X	A
Nitrogen, gas	F,1	F,1	F,1	F,1	F,1	A	A	A
Nitrogen, liquid	X	X	X	X	X	X	X	X
NORPAR 12, 13, 15	8	8	8	8	X	A	A	A
Nuto H 46, 68	A	A	A	A	X	A	A	A
Nyvac 20, 30, 200, FR	F	A	A	F	A	A	A	A
Nyvac Light	X	X	X	~	A	A	A	A
Oceanic HW	F	A	A	F	X	A	A	A
Oxygen	X	X	X	X	X	X	A	A
Ozone	F	F	F	~	A	A	A	A
Pacer SLC 150, 300, 500, 700	X	X	X	F	X	A	A	A

A

B

C

D

E

# Media

# Chemical Resistance Information (Page 7 of 9)

**Warning:** This chemical compatibility guide must not be used in conjunction with any other compatibility guides from previous or future catalog editions, bulletins or publications. Incorrect use of these charts could result in death, personal injury or property damage.

MEDIA	I	II	III	IV	V	Steel	Brass	SS
Pennzbell AWX	F	A	A	F	X	A	A	A
Perchloroethylene	X	X	X	X	X	F	X	A
Petroleum Ether	X	F	F	F	X	A	A	A
Petroleum Oils	A	A	A	A	X	A	A	A
Phenol (Carbolic Acid)	X	X	X	A	X	X	F	A
Phosphate Ester Blends	X	X	X	X	X	A	A	A
Phosphate Esters	X	X	X	X	A,7	A	A	A
Phosphoric Acid	X	X	X	X	X	X	X	F
Plurasafe P 1000, 1200	F	A	A	A	F	A	A	A
Polyalkylene Glycol	A	A	A	~	X	A	A	A
Polyol Ester	X	F	A	X	X	A	A	A
Potassium Chloride	A	A	A	A	A	X	F	F
Potassium Hydroxide	X	X	X	F	A	6	X	A
Potassium Sulfate	A	A	A	A	A	A	A	A
Propane			See numeral 11			A	A	A
Propylene Glycol	F	A	A	A	A	F	F	F
Pydraul 10-E, 29-E, 50-E, 65-E, 90-E, 115-E	X	X	X	X	A,7	A	A	A
Pydraul 230-C, 312-C, 68-S	X	X	X	X	A,7	A	A	A
Pydraul 60, 150, 625, F9	X	X	X	X	A,7	A	A	A
Pydraul 90, 135, 230, 312, 540, MC	X	X	X	X	X	A	A	A
Pydraul A-200	X	X	X	F	X	A	A	A
Pyro Gard 43, 230, 630	X	X	X	X	X	A	A	A
Pyro Gard C, D, R, 40S, 40W	F	A	A	F	X	A	A	A
Pyro Guard 53, 55, 51, 42	X	X	X	X	A,7	A	A	A
Quakerol 641, 720	X	F	A	X	F	A	A	A
Quintolubric 700	A	A	A	A	A	A	F	A
Quintolubric 807-SN	F	A	A	~	X	A	A	A
Quintolubric 822, 833	X	F,5	A,5	X	X	A	A	A
Quintolubric 822-68EHC (71°C, 160°F maximum)	X	F,5	A,5	~	~	A	A	A
Quintolubric 888	X	F,5	A,5	X	X	A	A	A
Quintolubric 957, 958	F	A	A	F	A	A	A	A
Quintolubric N822-300	~	~	A	~	~	A	A	A
Rando	A	A	A	A	X	A	A	A
Rayco 782	X	F	A	X	X	X	X	X
Refrigerant 124			See numeral 4			A	A	A
Refrigerant Freon 113, 114	X	X	X	X	X	A	A	A
Refrigerant Freon 12			See numeral 4			A	A	A
Refrigerant Freon 22			See numeral 4			A	A	A
Refrigerant Freon 502			See numeral 4			A	A	A
Refrigerant HFC134A			See numeral 4			A	A	A
Reolube Turbofluid 46	X	X	X	X	A,7	A	A	A
Rotella	A	A	A	A	X	A	A	A
Royal Bio Guard 3032, 3046, 3068, 3100	X	~	A	X	X	A	A	A
Royco 2200, 2210, 2222, 2232, 2246, 2268	X	X	X	X	X	A	A	A
Royco 4032, 4068, 4100, 4150	X	X	X	F	X	A	A	A

## Media

# Chemical Resistance Information

(Page 8 of 9)

**Warning:** This chemical compatibility guide must not be used in conjunction with any other compatibility guides from previous or future catalog editions, bulletins or publications. Incorrect use of these charts could result in death, personal injury or property damage.

MEDIA	I	II	III	IV	V	Steel	Brass	SS
Royco 756, 783	A	A	A	A	X	A	A	A
Royco 770	X	F	F	F	X	A	A	A
RTV Silicone Adhesive Sealants	X	X	X	X	X	A	A	A
Safco-Safe T10, T20	~	~	~	~	A	F	F	A
Safety-Kleen ISO 32, 46, 68 hydraulic oil	F	A	A	~	X	A	A	A
Safety-Kleen Solvent	F,8	F,8	F,8	F,8	X	A	A	A
Santoflex 13	F	F	F	~	F	A	A	A
Santosafe 300	X	X	X	~	X	A	A	A
Santosafe W/G 15 to 30	~	~	~	A	A	A	A	A
Schaeffer Oil #112 HTC @ 158°F max	A	A	A	~	X	A	A	A
Schaeffer Oil #112 HTC @ 158°F to 212°F	F	F	F	~	X	A	A	A
Schaeffer Oil #275 Dilex Supreme @ 158°F max	A	A	A	~	X	A	A	A
Schaeffer Oil #275 Dilex Supreme @ 158°F to 212°F	F	F	F	~	X	A	A	A
Sea Water	F	F	F	F	A	X	F	A
Sewage	F	F	F	A	F	X	F	A
Shell 140 Solvent	8	8	8	8	X	A	A	A
Shell Clavus HFC 68	X	X	X	X	X	A	A	A
Shell Comptella Oil	F	F	F	A	X	A	A	A
Shell Comptella Oil S 46, 68	F	F	F	A	X	A	A	A
Shell Comptella Oil SM	F	F	F	A	X	A	A	A
Shell Diala A, (R) Oil AX	F	A	A	F	X	A	A	A
Shell FRM	~	~	~	~	X	A	A	A
Shell IRUS 902, 905	A	A	A	~	A	A	A	A
Shell Pella-A	A	A	A	A	X	A	A	A
Shell Tellus	F	A	A	A	X	A	A	A
Shell Thermia Oil C	A	A	A	A	X	A	A	A
Shell Turbo R	X	F	F	A	X	A	A	A
SHF 220, 300, 450	X	X	A	X	X	A	A	A
Silicate Esters	A	F	F	A	X	A	A	A
Silicone Oils	A	A	A	~	~	A	A	A
Silicone Sealants	X	X	X	X	X	A	A	A
Skydrol 500B-4, LD-4	X	X	X	X	A,7	A	A	A
Soap Solutions	X	F	F	F	A	A	A	A
Soda Ash, Sodium Carbonate	A	A	A	A	A	A	F	A
Sodium Bisulfate	F	F	F	A	A	F	A	F
Sodium Chloride	F	F	F	A	A	X	F	A
Sodium Hydroxide	X	X	X	A	A	A	X	A
Sodium Hypochlorite	F	F	F	X	F	X	X	X
Sodium Nitrate	F	F	F	A	A	A	F	A
Sodium Peroxide	X	X	X	X	A	X	X	A
Sodium Silicate	A	A	A	A	A	A	A	A
Sodium Sulfate	A	A	A	A	A	A	A	A
Soybean Oil	F	A	A	A	A	A	A	A
SSR Coolant	X	X	X	F	X	A	A	A
Steam	X	X	X	X	X	F	A	A

## Media

Chemical Resistance  
Information (Page 9 of 9)

**Warning:** This chemical compatibility guide must not be used in conjunction with any other compatibility guides from previous or future catalog editions, bulletins or publications. Incorrect use of these charts could result in death, personal injury or property damage.

MEDIA	I	II	III	IV	V	Steel	Brass	SS
Stoddard Solvent	8	8	8	8	X	A	A	A
Sulfur Chloride	X	X	X	F	X	X	X	X
Sulfur Dioxide	X	X	X	X	F	X	F	F
Sulfur Trioxide	X	X	X	F	F	X	X	X
Sulfuric Acid 0%-30% Room Temp	F,6	F,6	F,6	X	F,6	6	X	6
Summa-20, Rotor, Recip	X	X	X	F	X	A	A	A
Summit DSL-32,68,100,125	X	X	X	F	X	A	A	A
Sun Minesafe, Sun Safe	X	F	F	F	X	A	A	A
Sundex 8125	X	F	F	~	A	A	A	A
Suniso 3GS	A	A	A	A	X	A	A	A
Sun-Vis 722	X	F	F	~	X	A	A	A
Super Hydraulic Oil 100, 150, 220	A	A	A	A	X	A	A	A
SUVA MP 39, 52, 66	X	X	X	X	X	A	A	A
SYNCON Oil	X	X	X	X	X	A	A	A
Syndale 2820	X	F	F	~	~	A	A	A
Synesstic 32,68,100	X	X	X	X	X	A	A	A
Syn-Flo 70,90	X	X	X	F	X	A	A	A
SYN-O-AD 8478	X	X	X	X	A,7	A	A	A
Tannic Acid	F	A	A	F	A	X	F	X
Tar	F	F	F	F	X	X	F	A
Tellus (Shell)	F	A	A	A	X	A	A	A
Texaco 760 Hydrafluid	~	~	~	~	X	A	A	A
Texaco 766, 763 (200 - 300)	~	~	~	~	A	F	F	A
Texaco A-Z Oil	A	A	A	F	X	A	A	A
Texaco Spindura Oil 22	F	F	F	F	X	A	A	A
Texaco Way Lubricant 68	A	A	A	A	X	A	A	A
Thanol-R-650-X	X	F	F	~	X	A	A	A
Thermanol 60	X	X	X	X	X	A	A	A
Toluene, Toluol	X	X	X	X	X	A	A	A
Transmission Oil	A	A	A	A	X	A	A	A
Tribol 1440	X	F	F	X	X	A	A	A
Trichloroethylene	X	X	X	F	X	X	A	A
Trim-Sol	F	A	A	F	X	A	A	A
Turbinol 50, 1122, 1223	X	X	X	X	A,7	A	A	A
Turpentine	X	X	X	F	X	A	A	A
Ucon Hydrolubes	F	A	A	F	A	A	A	A
UltraChem 215,230,501,751	X	X	X	F	X	A	A	A
Univis J26	A	A	A	A	X	A	A	A
Unleaded Gasoline			See numeral 9		~	A	A	A
Unocal 66/3 Mineral Spirits	8	8	8	8	X	A	A	A
Urea	F	F	F	A	F	F	~	F
Urethane Formulations	A	A	A	A	~	A	A	A
Van Straaten 902	A	A	A	A	X	A	A	A
Varnish	X	X	X	F	X	F	F	A
Varsol	8	F	F	8	X	A	A	A
Versilube F44, F55	~	A	A	A	~	A	A	A
Vinegar	X	X	X	F	A	F	X	A
Vital 29, 4300, 5230, 5310	X	X	X	X	X	A	A	A
Volt Esso 35	A	A	A	A	X	A	A	A
Water	F	A	A	A	A	F	A	A
Water / Glycols	A	A	A	A	A	A	F	A
Xylene, Xylol	X	X	X	X	X	A	A	A
Zerol 150	A	A	A	A	X	A	A	A
Zinc Chloride	A	A	A	X	A	X	X	F
Zinc Sulfate	A	A	A	X	A	X	A	A

# Pressure

# Pressure Rating of Hose End Connections

### PRESSURE RATINGS HOSE ASSEMBLIES - PSI

**THE MAXIMUM DYNAMIC WORKING PRESSURE OF THE HOSE ASSEMBLY IS THE LESSER OF THE RATED WORKING PRESSURE OF THE HOSE AND THE END CONNECTIONS USED.**

Hose End Connection Description	Part Number Codes	Inch Size Fittings (psi)												
		-2	-4	-5	-6	-8	-10	-12	-16	-20	-24	-32	-40	-48
Male Pipe (NPTF)	01	12,000	12,000		10,000	10,000		7,500	6,500	5,000	3,000	2,500		
Female Pipe (NPTF, NPSM)	02 & 07	7,500	7,000		6,000	5,000		4,000	3,000	2,500	2,000	2,000		
Male Pipe (BSP)	91 & D9	5,000	9,000		8,000	6,250		5,000	4,000	3,500	3,000	3,000		
Female Pipe (BSP)	92, B1, B2 & B4	5,000	9,000		8,000	6,250	5,500	5,000	4,000	3,500	3,000	3,000		
JIS	FU, GU, MU & UT		5,000		5,000	5,000		4,000	3,000	2,500	1,500	1,500		
O-Ring Swivel and 45° Flare*	13, 1L, S2, 0G, 0L, 48, 08, 77 & 79		3,000	3,000	3,000	3,000	2,750	2,250	2,000	1,625	1,250	1,125		
37° Flare and Straight Thread*	03, 05, 06**, 37, 39**, 41, L7 & L9		6,000	6,000	5,000	5,000	5,000	5,000	4,000	3,000	2,500	2,500		
SAE Flareless	11 & 12		6,000	6,000	5,600	5,600	4,200	4,200	3,500	3,500	3,000	3,000		
SAE Inverted Flare	28, 67 & 69		2,750	2,500	2,250	2,000								
Seal-Lok® (O-ring Face Seal)	JM, JC, JS, J0, J1, J5, J7 & J9		9,200		9,200	9,200	6,000	6,000	6,000	4,000	4,000	3,000		
SAE Flanges Code 61	15, 16, 17, 18, 19, 26, 27 & 89					5,000		5,000	5,000	4,000	4,000	3,000	2,500	2,000
SAE Flanges Code 61 Special	4A, 4B, 4F, 4G & 4N									5,000	5,000	5,000		
SAE Flanges Code 62	6A, 6E, 6F, 6G, 6N, XA, XF, XG & XN							6,000	6,000	6,000	6,000	6,000		

For adapter pressure ratings, see Tube Fittings Division catalog 4300.

\*NOTE: 45°, 37° and Seal-Lok Torque Tables are on page E-19

\*\*NOTE: For pressure rating of 01, 06 and 39 end configurations in 73, 77, 78, and 79 series, see each description in Section B.

Hose End Connection Description	Part Number Codes	Metric Fittings (psi)															
		-6	-8	-10	-12	-14	-15	-16	-18	-20	-22	-25	-28	-30	-35	-38	-42
DIN Light "L" without O-Ring	C3, C4, C5 & 1D	3,500	3,500	3,500	3,500		3,500		2,250		2,250		1,400		1,400		1,400
DIN Light "L" with O-Ring	D0, CA, CE & CF	4,500	4,500	4,500	4,500		4,500		2,250		2,250		2,250		2,250		2,250
DIN Heavy "S" without O-Ring	C6, C7, C8 & 3D		9,000	9,000	9,000	9,000		5,750		5,750		5,750		3,500		3,500	
DIN Heavy "S" with O-Ring	C9, 0C, 1C & D2		9,000	9,000	9,000	9,000		6,000		6,000		6,000		6,000		4,500	
DIN 20078 Form C	C0									900		900		900		900	
Banjo	49	3,000	3,000	3,000	3,000		3,000		3,000	3,000	3,000						
French Metric	F9 & FA			3,000	3,500	2,000			2,250	2,000	1,900			1,750			

Hose End Connection Description	Part Number Codes	French Gaz Fittings (psi)				
		-13	-17	-21	-27	-33
French Gaz	F4, FG, GJ & GE	5,250	3,900	3,700	3,000	2,500

\*NOTE: ALL THE ABOVE RATINGS ARE BASED ON LOW CARBON STEEL HOSE FITTINGS. HIGHER PRESSURE RATINGS CAN BE ATTAINED WITH MEDIUM CARBON AND ALLOY STEEL HOSE FITTINGS AND MATING ADAPTERS.

The Maximum working pressure of hoses are listed with each hose description in Section A.



Pressure

Metric Pressure Conversions

PRESSURE CONVERSIONS									
Kilo-Pascals (kPa)	Mega-Pascals (MPa)	Bar (bar)	Kilograms per Square Centimeter (Kgf/cm <sup>2</sup> )	lbs per Square Inch (psi)	lbs per Square Inch (psi)	Kilo-Pascals (kPa)	Mega-Pascals (MPa)	Bar (bar)	Kilograms per Square Centimeter (Kgf/cm <sup>2</sup> )
100	0,1	1,00	1.0	14.50	10	68.9	0,07	0,7	0.70
200	0,2	2,00	2.0	29.00	20	137.9	0,14	1,4	1.41
300	0,3	3,00	3.1	43.50	30	206.8	0,21	2,1	2.11
400	0,4	4,00	4.1	58.00	40	275.8	0,28	2,8	2.81
500	0,5	5,00	5.1	72.50	50	344.7	0,34	3,4	3.52
600	0,6	6,00	6.1	87.00	60	413.7	0,41	4,1	4.22
700	0,7	7,00	7.1	101.50	70	482.6	0,48	4,8	4.92
800	0,8	8,00	8.2	116.00	80	551.6	0,55	5,5	5.63
900	0,9	9,00	9.2	130.50	90	620.5	0,62	6,2	6.33
1000	1,0	10,00	10.2	145.00	100	689.0	0,70	6,9	7.00
2000	2,0	20,00	20.4	290.10	200	1379.0	1,40	13,8	14.10
3000	3,0	30,00	30.6	435.10	300	2068.0	2,10	20,7	21.10
4000	4,0	40,00	40.8	580.20	400	2758.0	2,80	27,6	28.10
5000	5,0	50,00	51.0	725.20	500	3447.0	3,40	34,5	35.20
6000	6,0	60,00	61.2	870.20	600	4137.0	4,10	41,4	42.20
7000	7,0	70,00	71.4	1015.30	700	4826.0	4,80	48,3	49.20
8000	8,0	80,00	81.6	1160.30	800	5516.0	5,50	55,2	56.30
9000	9,0	90,00	91.8	1305.30	900	6205.0	6,20	62,1	63.30
10000	10,0	100,00	102.0	1450.00	1000	6895.0	6,90	68,9	70.30
20000	20,0	200,00	204.0	2901.00	2000	13790.0	13,80	137,9	140.70
30000	30,0	300,00	306.0	4351.00	3000	20684.0	20,70	206,8	211.00
40000	40,0	400,00	408.0	5802.00	4000	27579.0	27,60	275,8	281.30
50000	50,0	500,00	510.0	7252.00	5000	34474.0	34,50	344,7	351.60
60000	60,0	600,00	612.0	8702.00	6000	41369.0	41,40	413,7	421.90
70000	70,0	700,00	714.0	10153.00	7000	48263.0	48,30	482,6	492.30
80000	80,0	800,00	816.0	11603.00	8000	55158.0	55,20	551,6	562.60
90000	90,0	900,00	918.0	13053.00	9000	62053.0	62,10	620,5	632.90
100000	100,0	1000.00	1020.0	14504.00	10000	68948.0	68,90	689,0	703.00
200000	200,0	2000.00	2040.0	29008.00	20000	137895.0	137,90	1379,0	1406.00
300000	300,0	3000.00	3060.0	43511.00	30000	206843.0	206,80	2068,0	2110.00
					40000	275790.0	275,80	2758,0	2813.00

# Conversions

## PSI and MPa or N/mm<sup>2</sup> Conversions

Pounds per Square Inch (abbrev. PSI) - A basic unit of pressure or tension measurement in the Imperial or English System of Weights and Measures.

$$1 \text{ psi} = .006895 \text{ MPa},$$

$$1000 \text{ psi} = 1 \text{ ksi}$$

MegaPascal (abbrev. MPa) - A basic unit of pressure or tension measurement in the International System of Weights and Measures.

$$1 \text{ MPa} = 145 \text{ psi},$$

$$1 \text{ MPa} = 1 \text{ N/mm}^2.$$

For oil field applications, units of measurement smaller than 1 psi usually have little meaning. Units of MPa may often appear with a decimal.

$$\text{Example: } 1000 \text{ psi} = 6.895 \text{ MPa}.$$

$$1 \text{ MegaPascal (MPa)} = 1 \text{ Newton per Square Millimeter (N/mm}^2) = 145 \text{ Pounds per Square Inch (psi)}.$$

Psi, Ksi, MPa, and N/mm<sup>2</sup> all express force measurement, either pressure (as fluid pressure) or load (as tension). All of these terms may appear as pressure ratings or test pressures, and tensile or yield requirements or test results.

### API Spec 6A specifies equipment pressure ratings in both PSI, and MPa as:

2,000 psi	=	13.8 MPa	=	138 bar
3,000 psi	=	20.7 MPa	=	207 bar
5,000 psi	=	34.5 MPa	=	345 bar
10,000 psi	=	69.0 MPa	=	690 bar
15,000 psi	=	103.5 MPa	=	1,035 bar
20,000 psi	=	138.0 MPa	=	1,380 bar

Bar pressure provided for information only.

To express PSI pressures in bars, convert PSI to MPa and move the decimal in the MPa value 1 space to the right, e.g. 5000 PSI = 34.5 MPa = 345 bar.

### API Spec 6A specifies material property requirements\* as:

Material Designation	Yield		Tensile	
	PSI	MPa	PSI	MPa
36 K	36,000	248	70,000	483
45 K	45,000	310	70,000	483
60 K	60,000	414	85,000	586
75 K	75,000	517	95,000	655

\*For Elongation and Reduction of Area, see API Spec 6A. The values specified for these requirements do not require conversion.

PART NUMBER	PAGE NUMBER	PART NUMBER	PAGE NUMBER	PART NUMBER	PAGE NUMBER
0188	B-194	3988	B-196	11877	B-102
017M	B-6	8888	B-199	11943	B-43
187	A-13	10081	B-199	11970	B-67
201	A-45	10125	B-6	11971	B-82
206	A-46	10126	B-11	11977	B-103
213	A-43	10143	B-30	12643	B-42
239	C-24	10170	B-66	12671	B-80
244	A-53	10171	B-76	12677	B-99
266	A-44	10177	B-92	12743	B-43
271	A-48	10243	B-32	12771	B-81
285	A-52	10277	B-92	12777	B-101
293	A-42	10326	B-11	12826	B-14
302	A-23	10343	B-34	12843	B-40
304	A-38	10370	B-66	13726	B-12
339	C-24	10371	B-76	13743	B-36
387	A-14	10377	B-93	13771	B-77
422	A-20	10426	B-13	13777	B-95
424	A-37	10443	B-38	13926	B-12
426	A-22	10543	B-33	13943	B-37
436	A-24	10571	B-76	13970	B-66
487	A-15	10577	B-96	13971	B-78
0143	B-30	10626	B-12	13977	B-95
0588	B-195	10643	B-35	14126	B-13
0688	B-195	10670	B-66	14143	B-38
627	A-36	10671	B-77	14171	B-78
722	A-16	10677	B-94	14177	B-96
774	A-37	10743	B-32	14943	B-62
777	A-29	10825	B-6	16743	B-40
787	A-17	10826	B-13	16826	B-14
797	A-18	10843	B-38	16926	B-15
801	A-32	11143	B-39	16943	B-41
804	A-34	11243	B-40	17726	B-13
811	A-31	11343	B-31	17743	B-39
821	A-35	11543	B-41	17926	B-14
836	A-34	11571	B-79	17943	B-39
881	A-31	11577	B-98	18971	B-83
1543	B-42	11643	B-42	18977	B-104
1588	B-196	11671	B-79	19243	B-60
1788	B-197	11677	B-99	19270	B-71
1988	B-197	11743	B-42	19277	B-121
2188	B-194	11770	B-67	20120	B-146
2726	C-29	11771	B-80	20121	B-156
2727	C-29	11777	B-100	20122	B-164
3188	B-194	11843	B-43	20130	B-168
3788	B-195	11871	B-81	20142	B-174

A

B

C

D

E



PART NUMBER	PAGE NUMBER	PART NUMBER	PAGE NUMBER	PART NUMBER	PAGE NUMBER
20320	B-146	30282	B-180	11D43	B-53
20330	B-169	30382	B-180	11L43	B-31
20342	B-174	30482	B-182	11LHY	B-132
20420	B-148	30682	B-181	128HY	B-139
20620	B-147	30882	B-183	129HY	B-140
20621	B-156	31382	B-179	137HY	B-136
20622	B-164	32882	B-184	139HY	B-136
20630	B-169	32982	B-185	13D43	B-57
20642	B-175	33782	B-181	13DHY	B-143
20820	B-149	33982	B-182	141HY	B-137
20821	B-157	34182	B-182	14526-PT	B-18
20822	B-164	34982	B-189	14A77	B-98
20842	B-176	36782	B-184	14B77	B-99
21120	B-150	36982	B-184	14E77	B-100
21330	B-168	37782	B-183	14F77	B-101
21342	B-174	37982	B-183	14G77	B-102
21520	B-151	38282	B-187	14GZ	B-24
21720	B-152	39282	B-188	14M77	B-103
21920	B-152	580661	C-24	14N77	B-104
22820	B-150	652200	C-29	15926-PB	B-19
22821	B-158	652201	C-29	15926-PT	B-19
23220	B-151	662451	C-28	15G26	B-18
23221	B-158	711509	D-17	15H26	B-19
23720	B-147	711510	D-17	15K26	B-17
23721	B-156	871522	C-27	15K26-PB	B-17
23730	B-170	881540	C-27	15L26	B-20
23742	B-175	101HY	B-131	15L26-PB	B-20
23920	B-148	102HY	B-132	15L26-PT	B-21
23921	B-157	103HY	B-134	15M26-PT	B-18
23930	B-170	105HY	B-133	15N26-PB	B-20
23942	B-175	106HY	B-135	15N26-PT	B-20
24120	B-148	107HY	B-132	15P26-PT	B-21
24248	C-24	108HY	B-137	15R26	B-17
24398	C-24	10C43	B-59	15S26	B-18
26120	B-151	10C70	B-70	15T26	B-19
26720	B-150	10C77	B-118	15T3	D-5
26721	B-159	10G43	B-33	15V26	B-22
26920	B-151	10GHY	B-133	15W26	B-22
26921	B-159	10L43	B-34	15Z26	B-22
27720	B-149	10LHY	B-134	167HY	B-139
27721	B-157	111HY	B-138	169HY	B-140
27920	B-149	113HY	B-131	16A43	B-44
27921	B-158	11C43	B-59	16A70	B-67
28120	B-150	11C70	B-71	16A71	B-83
30182	B-179	11C77	B-119	16A77	B-105

PART NUMBER	PAGE NUMBER	PART NUMBER	PAGE NUMBER	PART NUMBER	PAGE NUMBER
16A79	B-126	1D043	B-53	1J777	B-115
16B77	B-105	1D0HY	B-143	1J779	B-127
16E77	B-106	1D243	B-56	1J7HY	B-141
16F71	B-84	1D270	B-73	1J926	B-16
16F43	B-44	1D277	B-117	1J943	B-49
16F77	B-106	1D943	B-60	1J970	B-69
16F79	B-126	1D970	B-73	1J971	B-86
16G77	B-107	1D977	B-121	1J977	B-116
16N43	B-44	1D9HY	B-143	1J979	B-128
16N70	B-68	1EA77	B-121	1J9HY	B-142
16N71	B-84	1EN43	B-52	1JB43	B-45
16N77	B-107	1ET43	B-52	1JB77	B-113
16N79	B-126	1EU43	B-52	1JC26	B-15
177HY	B-138	1FG70	B-70	1JC43	B-46
179HY	B-138	1FU43	B-63	1JC70	B-68
17B25	B-6	1FU71	B-89	1JC71	B-85
17B26	B-21	1FU77	B-119	1JC77	B-114
17T3	D-5	1GJ43	B-40	1JCHY	B-140
19T3	D-5	1GJHY	B-139	1JS43	B-47
43 Series Crimp Shell	B-64	1GU43	B-64	1JS70	B-68
1AP77	B-92	1GU70	B-70	1JS71	B-85
1B143	B-61	1GU71	B-88	1JS77	B-114
1B170	B-71	1GU77	B-122	1JS79	B-127
1B177	B-122	1GUHY	B-144	1JSHY	B-141
1B243	B-61	1HB77	B-93	1K377	B-112
1B270	B-72	1HE77	B-93	1K577	B-111
1B277	B-123	1HN77	B-93	1K677	B-112
1B443	B-61	1J043	B-45	1K777	B-112
1B543	B-62	1J071	B-84	1K877	B-113
1C043	B-58	1J077	B-115	1K977	B-113
1C343	B-54	1J0HY	B-140	1KA77	B-111
1C443	B-54	1J143	B-50	1KU77	B-120
1C543	B-54	1J170	B-69	1L743	B-36
1C643	B-57	1J171	B-87	1L943	B-37
1C943	B-58	1J177	B-117	1L971	B-78
1C970	B-72	1J1HY	B-142	1LB43	B-35
1C971	B-88	1J543	B-49	1MU43	B-63
1C977	B-118	1J570	B-69	1MU71	B-89
1CA43	B-55	1J571	B-87	1MU77	B-120
1CA70	B-72	1J577	B-116	1RV26	B-22
1CA77	B-123	1J643	B-47	1S243	B-32
1CE43	B-55	1J726	B-16	1S526	B-16
1CE70	B-73	1J743	B-48	1T126	B-23
1CF43	B-56	1J770	B-69	1UT43	B-64
1CF70	B-73	1J771	B-86	1UTHY	B-144

A

B

C

D

E

PART NUMBER	PAGE NUMBER	PART NUMBER	PAGE NUMBER	PART NUMBER	PAGE NUMBER
1X577	B-96	3D982	B-188	80C-SDR-XXXX	C-28
1X777	B-97	3J782	B-186	811HT	A-31
1X977	B-97	3J982	B-186	821FR	A-35
1XA77	B-108	3JC82	B-185	82C-061L	C-7
1XA79	B-128	40B-Cabinet	D-39, D-40	82C-0AP	C-17
1XB77	B-108	41T3	D-6	82C-0EP	C-17
1XE77	B-109	432-115V	C-28	82C-0HP	C-16
1XF77	B-109	471ST	A-25	82C-CHD	C-7
1XG77	B-110	471TC	A-25	82C-CVR	C-30
1XM77	B-110	471TC Twin Tough	A-26	82C-KKB	C-7
1XN77	B-111	472LT	A-40	82C-R01	C-7
1XU43	B-63	472TC	A-27	82C-R02	C-7
1XU71	B-89	482ST	A-21	83C-080	C-12
1XU77	B-120	482TC	A-21	83C-081	C-12
1XUHY	B-144	4AH3	D-6	88C-082	C-12
1ZG26-PB	B-25	4AJM	D-8	83C-0DR	C-28
1ZG26-PT	B-25	4FH3	D-7	83C-CVR	C-30
1ZM77	B-123	4FJM	D-8	83C-OCB	C-12
237.239.2L2	C-14	4NH3	D-7	83C-R02	C-12
221FR	A-51	4NJM	D-8	83C-R02H	C-12
25H21	B-160	4PG	D-23	83C-S20	C-12
25L21	B-161	5050HK	D-11	83C-S40	C-12
25M21	B-160	50H	D-10	85C-00L	C-7, C-9
25N21	B-161	5151HK	D-11	85C-03L	C-7, C-9
25S21	B-160	51H	D-11	85C-061L	C-9
25T21	B-161	59RG	D-19	85C-0EP	C-17
2J120	B-153	5SGZ	B-24	85C-0HP	C-16
2J720	B-152	611HT	A-47	85C-CHD	C-9
2J920	B-153	6AH3	D-7	85C-KKB	C-9
2J930	B-171	6AJM	D-9	85C-R01	C-9
2JS20	B-152	6FH3	D-7	85C-R02	C-9
2JS30	B-171	6FJM	D-9	85C-STD	C-7, C-9
2JS42	B-176	6NH3	D-8	85C-ZMS	C-7, C-9
2S521	B-159	6NJM	D-9	86C-220V	C-23
31D82	B-187	6PG	D-23	86C-220V3	C-23
332T-115V	C-24	722LT	A-41	8888	B-199
37G82	B-180	722TC	A-28	88DB	B-199
39T3	D-6	722ST	A-28	88DB Clamp	D-38
3B282	B-188	72B-Cabinet	D-41	88HC	B-199
3C382	B-191	792LT	A-41	88HC-H	B-199
3C482	B-190	7PG	D-23	88HC-H Wormgear	D-38
3C582	B-191	80C-0DR	C-28	8ARG	D-18
3CA82	B-190	80C-SDR-BASE	C-28	8WC-001	C-16
3CF82	B-190	80C-SDR-LG	C-28	Accrolube	C-30
3D082	B-187	80C-SDR-SM	C-28	AM	B-189

PART NUMBER	PAGE NUMBER	PART NUMBER	PAGE NUMBER	PART NUMBER	PAGE NUMBER
AM Banjo Bolt	B-62	Parker Clean Seal	C-26	PCS-2840P	C-26
AS-B	D-22	Parkrimp 2	C-12	PCS-3133P	C-26
AS-Y	D-22	Partek Defense	D-20	PCS-3140P	C-26
Clamp (Wormgear)	B-199	Partek Sleeve	D-22	PCS-3440P	C-26
CL Clamp	D-37	Partek Wrap	D-21	PCS-3840P	C-26
CORG	D-19	PolyGuard (HG)	D-22	PCS-3840P	C-26
Crimpsource	C-18	Polyguard Strain Reliever	D-23	PCS-4345P	C-26
D9DT	D-17	ParKoil™ (PG)	D-22	PCS-4650P	C-26
EFS	D-16	PB237L-69	C-15	PCS-5260P	C-26
F42	A-39	PB237L-74	C-15	PCS-5860P	C-26
FSC Clamp	D-24	PB239-50-14	C-15	PCS-6760P	C-26
FS-F	D-24	PB239-65-17	C-15	PG	D-22
Firesleeve (FS-F)	D-24	PB239-65-20	C-15	Protective Coils, Sleeves & Guards Selection Guide	D-26 - D-32
Firesleeve Tape	D-24	PB239-65-24	C-15	Protection Shields	D-25
HC Clamp	D-38	PB239-65-26	C-15	PS.2 Double	C-14
HFH	D-12	PB239-80-28	C-15	PS-B	D-21
HFHFHK	D-12	PB239-80-31	C-15	PS-BV	D-21
HG	D-22	PB239-80-34	C-15	QDC239.5	C-14
Hose Assembly Workstations	D-39	PB239-80-38	C-15	QDS239C	C-14
HoseFab Table	D-40	PB239-80-40	C-15	QDS239R	C-14
Hose Oil	C-30	PB239-80-44	C-15	QDS239S	C-14
Hose Whip Restraint	D-33	PB239-100-50	C-15	Rotary Reel Rack	D-40
HP	D-25	PB239-100-54	C-15	R12X	D-13
HP-B	D-25	PB239-100-57	C-15	R16X	D-13
HR6 Hose Bin	D-41	PB239-100-62	C-15	R20X	D-13
HT	D-25	PCS-2023B	C-26	R24X	D-13
HU1A	D-22	PCS-2030B	C-26	R32X	D-13
HU1A-PT	D-23	PCS-2224B	C-26	RK-12	D-13
J0RG	D-18	PCS-2527B	C-26	RK-16	D-13
J788	B-198	PCS-2540B	C-26	RK-20	D-13
J988	B-198	PCS-2840B	C-26	RK-24	D-13
JC88	B-198	PCS-3133B	C-26	RK-32	D-13
JK	A-19	PCS-3140B	C-26	S5GZ	B-24
JS88	B-197	PCS-3440B	C-26	Saw Table	D-40
Karrykrimp	C-7	PCS-3840B	C-26	SG	D-23
Karrykrimp Bench Mount	C-7	PCS-4345B	C-26	SHS 375/380	C-14
Karrykrimp 2	C-9	PCS-4650B	C-26	Small Crimper Hood	C-30
Karrykrimp 2 Bench Mount	C-9	PCS-5260B	C-26	Spring Guard (SG)	D-23
Large Crimper Hood	C-30	PCS-5860B	C-26	SS23CG	A-49
LUS	C-14	PCS-6760B	C-26	SS25UL	A-50
M1H	D-14	PCS-2023P	C-26	SS25UL-AGA	A-50
M1M1HK	D-14	PCS-2030P	C-26	T1RG	D-19
M2H	D-15	PCS-2224P	C-26	TH11-1	C-27
M2M2HK	D-15	PCS-2527P	C-26	TH2-7	C-28
		PCS-2540P	C-26	TH2-7-ELS	C-28
				TH2-7M25-6	C-29

PART NUMBER	PAGE NUMBER	PART NUMBER	PAGE NUMBER	PART NUMBER	PAGE NUMBER
TH2-7M25-8	C-29	TH9-1-43B	C-27	WRC3031	D-33, D-35
TH6-10-EL-8	C-25	TH9-1-77	C-27	WRC3435	D-33, D-35
TH6-10-H06	C-25	TH9-1-HY	C-27	WRC3637	D-33, D-35
TH6-10-H10	C-25	UC-1.5HD	C-26	WRC3839	D-33, D-35
TH6-10-H13	C-25	UC-CSS-230V	C-26	WRC4243	D-33, D-35
TH6-10-H16	C-25	UC-HG-STAND	C-26	WRC4445	D-33, D-35
TH6-10-H19	C-25	UC-HL1910E	C-26	WRC4547	D-33, D-35
TH6-10-H25	C-25	WRA115	D-34, D-36	WRC4850	D-33, D-35
TH6-10-H32	C-25	WRA132	D-34, D-36	WRC5153	D-33, D-35
TH6-10-H38	C-25	WRA145	D-34, D-36	WRC5456	D-33, D-35
TH6-10-H50	C-25	WRA148	D-34, D-36	WRC6365	D-33, D-35
TH6-10-J06	C-25	WRA170	D-34, D-36	WRC6971	D-33, D-35
TH6-10-J10	C-25	WRA185	D-34, D-36	WRF085	D-34, D-36
TH6-10-J13	C-25	WRA195	D-34, D-36	WRF105	D-34, D-36
TH6-10-J16	C-25	WRA205	D-34, D-36	WRF125	D-34, D-36
TH6-10-J19	C-25	WRA225	D-34, D-36	WRF145	D-34, D-36
TH6-10-J25	C-25	WRA245	D-34, D-36	WRF165	D-34, D-36
TH6-10-J32	C-25	WRA265	D-34, D-36	WRF205	D-34, D-36
TH6-10-J38	C-25	WRA275	D-34, D-36	XARG	D-18
TH6-10-HL-10-2	C-25	WRA305	D-34, D-36	XCXCHK	D-15
TH6-10-P06	C-25	WRA340	D-34, D-36	XRG-12	D-13
TH6-10-P10	C-25	WRA340S	D-34, D-36	XRG-16	D-13
TH6-10-P12	C-25	WRA340JIC	D-34, D-36	XRG-20	D-13
TH6-10-P14	C-25	WRA365	D-34, D-36	XRG-24	D-13
TH6-10-P16	C-25	WRA415S	D-34, D-36	XRG-32	D-13
TH6-10-P18	C-25	WRA415	D-34, D-36	ZJGZ	B-25
TH6-10-P22	C-25	WRA425	D-34, D-36	ZKGZ	B-25
TH6-10-P26	C-25	WRA455	D-34, D-36		
TH6-10-P33	C-25	WRA480S	D-34, D-36		
TH6-10-P40	C-25	WRA480	D-34, D-36		
TH6-10-P50	C-25	WRA490	D-34, D-36		
TH6-10-P60	C-25	WRA525	D-34, D-36		
TH7-4	D-39	WRA600	D-34, D-36		
TH7-5-C	D-39, D-40	WRA640	D-34, D-36		
TH7-5-HT	D-39, D-40	WRC1212	D-33, D-35		
TH7-5-R	D-40	WRC1313	D-33, D-35		
TH7-5-S	D-40	WRC1415	D-33, D-35		
TH7-6	D-39, D-40	WRC1718	D-33, D-35		
TH7-6-C	D-39, D-40	WRC1819	D-33, D-35		
TH7-7	D-39, D-40	WRC2021	D-33, D-35		
TH7-8	D-39, D-40	WRC2223	D-33, D-35		
TH7-8-F	D-39, D-40	WRC2425	D-33, D-35		
TH9-1-26A	C-27	WRC2526	D-33, D-35		
TH9-1-26B	C-27	WRC2728	D-33, D-35		
TH9-1-43A	C-27	WRC2829	D-33, D-35		

**Male Pipe Thread Sizes**



**SAE (JIC) 37° Flare Nose Cone Sizes**

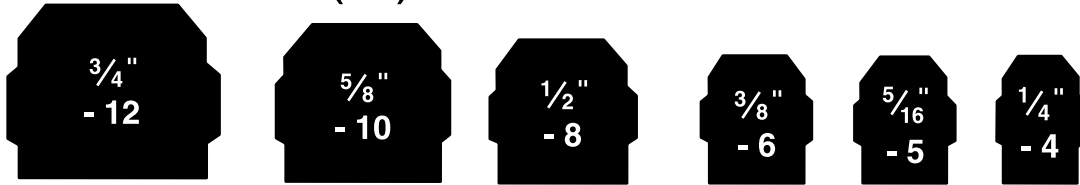

**SAE (JIC) 37° Flare Nose Cone Sizes**

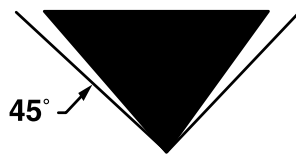
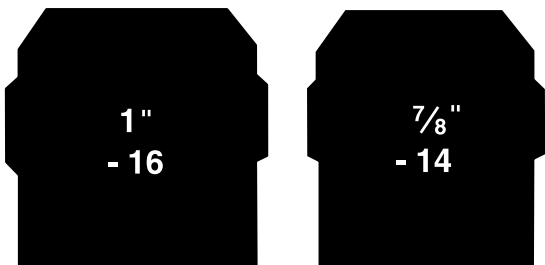
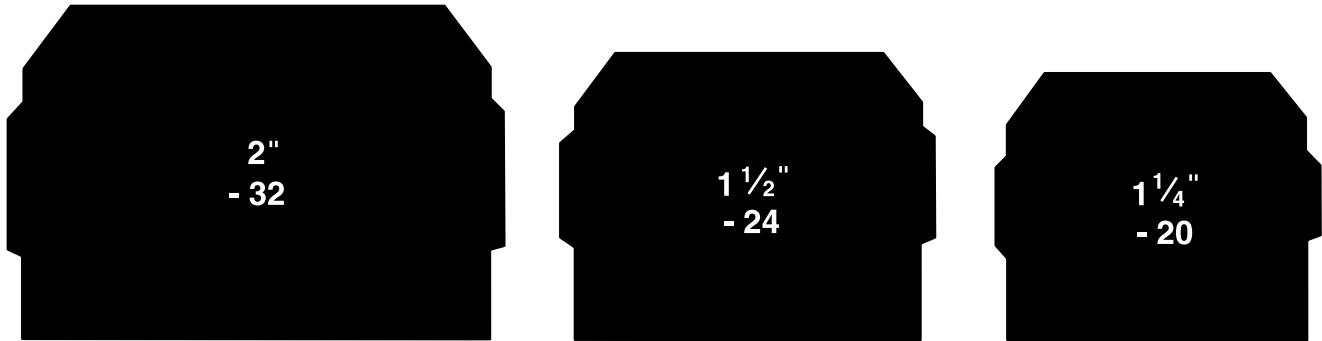

**37° and 45° Flare  
Nose Angles**

**SAE 45° Flare  
Nose Cone Sizes**

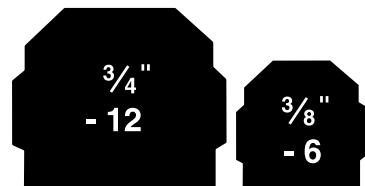

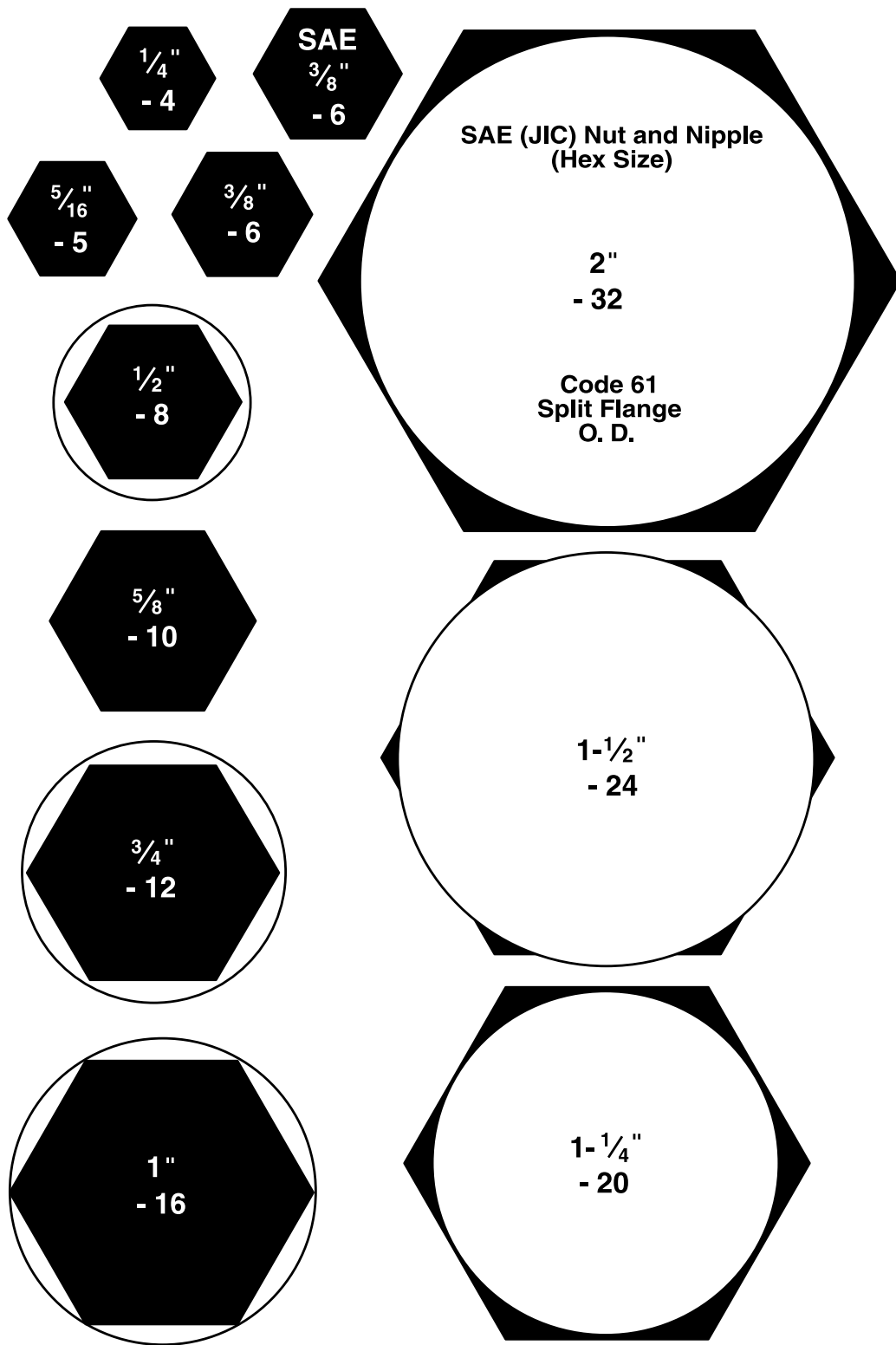

A

B

C

D

E



## Parker Safety Guide for Selecting and Using Hose, Tubing, Fittings, Connectors, Conductors, Valves and Related Accessories

Parker Publication No. 4400-B.1

**WARNING:** Failure or improper selection or improper use of hose, tubing, fittings, assemblies, valves, connectors, conductors or related accessories (“Products”) can cause death, personal injury and property damage. Possible consequences of failure or improper selection or improper use of these Products include but are not limited to:

- Fittings thrown off at high speed.
- High velocity fluid discharge.
- Explosion or burning of the conveyed fluid.
- Electrocution from high voltage electric powerlines.
- Contact with suddenly moving or falling objects that are controlled by the conveyed fluid.
- Injections by high-pressure fluid discharge.
- Dangerously whipping Hose.
- Tube or pipe burst.
- Weld joint fracture.
- Contact with conveyed fluids that may be hot, cold, toxic or otherwise injurious.
- Sparking or explosion caused by static electricity buildup or other sources of electricity.
- Sparking or explosion while spraying paint or flammable liquids.
- Injuries resulting from inhalation, ingestion or exposure to fluids.

Before selecting or using any of these Products, it is important that you read and follow the instructions below. No product from any division in Parker Fluid Connectors Group is approved for in-flight aerospace applications. For hoses and fittings used in in-flight aerospace applications, please contact Parker Aerospace Group.

### 1.0 GENERAL INSTRUCTIONS

**1.1 Scope:** This safety guide provides instructions for selecting and using (including assembling, installing, and maintaining) these Products. For convenience, all rubber and/or thermoplastic products commonly called “hose” or “tubing” are called “Hose” in this safety guide. Metallic tube or pipe are called “tube”. All assemblies made with Hose are called “Hose Assemblies”. All assemblies made with Tube are called “Tube Assemblies”. All products commonly called “fittings”, “couplings” or “adapters” are called “Fittings”. Valves are fluid system components that control the passage of fluid. Related accessories are ancillary devices that enhance or monitor performance including crimping, flaring, flanging, presetting, bending, cutting, deburring, swaging machines, sensors, tags, lockout handles, spring guards and associated tooling. This safety guide is a supplement to and is to be used with the specific Parker publications for the specific Hose, Fittings and Related Accessories that are being considered for use. Parker publications are available at [www.parker.com](http://www.parker.com). SAE J1273 ([www.sae.org](http://www.sae.org)) and ISO 17165-2 ([www.ansi.org](http://www.ansi.org)) also provide recommended practices for hydraulic Hose Assemblies, and should be followed.

**1.2 Fail-Safe:** Hose, Hose Assemblies, Tube, Tube Assemblies and Fittings can and do fail without warning for many reasons. Design all systems and equipment in a fail-safe mode, so that failure of the Hose, Hose Assembly, Tube, Tube Assembly or Fitting will not endanger persons or property.

**1.3 Distribution:** Provide a copy of this safety guide to each person responsible for selecting or using Hose, Tube and Fitting products. Do not select or use Parker Hose, Tube or Fittings without thoroughly reading and understanding this safety guide as well as the specific Parker publications for the Products.

**1.4 User Responsibility:** Due to the wide variety of operating conditions and applications for Hose, Tube and Fittings. Parker does not represent or warrant that any particular Hose, Tube or Fitting is suitable for any specific end use system. This safety guide does not analyze all technical parameters that must be considered in selecting a product. The user, through its own analysis and testing, is solely responsible for:

- Making the final selection of the Products.
- Assuring that the user’s requirements are met and that the application presents no health or safety hazards.
- Following the safety guide for Related Accessories and being trained to operate Related Accessories.
- Providing all appropriate health and safety warnings on the equipment on which the Products are used.
- Assuring compliance with all applicable government and industry standards.

**1.5 Additional Questions:** Call the appropriate Parker technical service department if you have any questions or require any additional information. See the Parker publication for the Products being considered or used, or call 1-800-CPARKER, or go to [www.parker.com](http://www.parker.com), for telephone numbers of the appropriate technical service department.

### 2.0 HOSE, TUBE AND FITTINGS SELECTION INSTRUCTIONS

**2.1 Electrical Conductivity:** Certain applications require that the Hose be nonconductive to prevent electrical current flow. Other applications require the Hose and the Fittings and the Hose/Fitting interface to be sufficiently conductive to drain off static electricity. Extreme care must be exercised when selecting Hose, Tube and Fittings for these or any other applications in which electrical conductivity or nonconductivity is a factor.

The electrical conductivity or nonconductivity of Hose, Tube and Fittings is dependent upon many factors and may be susceptible to change. These factors include but are not limited to the various materials used to make the Hose and the Fittings, Fitting finish (some Fitting finishes are electrically conductive while others are nonconductive), manufacturing methods (including moisture control), how the Fittings contact the Hose, age and amount of deterioration or damage or other changes, moisture content of the Hose at any particular time, and other factors.

The following are considerations for electrically nonconductive and conductive Hose. For other applications consult the individual catalog pages and the appropriate industry or regulatory standards for proper selection.

**2.1.1 Electrically Nonconductive Hose:** Certain applications require that the Hose be nonconductive to prevent electrical current flow or to maintain electrical isolation. For applications that require Hose to be electrically nonconductive, including but not limited to applications near high voltage electric lines, only special nonconductive Hose can be used. The manufacturer of the equipment in which the nonconductive Hose is to be used must be consulted to be certain that the Hose, Tube and Fittings that are selected are proper for the application. Do not use any Parker Hose or Fittings for any such application requiring nonconductive Hose, including but not limited to applications near high voltage electric lines or dense magnetic fields, unless (i) the application is expressly approved in the Parker technical publication for the product, (ii) the Hose is marked “nonconductive”, and (iii) the manufacturer of the equipment on which the Hose is to be used specifically approves the particular Parker Hose, Tube and Fittings for such use.

**2.1.2 Electrically Conductive Hose:** Parker manufactures special Hose for certain applications that require electrically conductive Hose. Parker manufactures special Hose for conveying paint in airless paint spraying applications. This Hose is labeled “Electrically Conductive Airless Paint Spray Hose” on its layline and packaging. This Hose must be properly connected to the appropriate Parker Fittings and properly grounded in order to dissipate dangerous static charge buildup, which occurs in all airless paint spraying applications. Do not use any other Hose for airless paint spraying, even if electrically conductive. Use of any other Hose or failure to properly connect the Hose can cause a fire or an explosion resulting in death, personal injury, and property damage. All hoses that convey fuels must be grounded.

Parker manufactures a special Hose for certain compressed natural gas (“CNG”) applications where static electricity buildup may occur. Parker CNG Hose assemblies comply with the requirements of ANSI/IAS NGV 4.2; CSA 12.52, “Hoses for Natural Gas Vehicles and Dispensing Systems” ([www.ansi.org](http://www.ansi.org)). This Hose is labeled “Electrically Conductive for CNG Use” on its layline and packaging. This Hose must be properly connected to the appropriate Parker Fittings and properly grounded in order to dissipate dangerous static charge buildup, which occurs in, for example, high velocity CNG dispensing or transfer. Do not use any other Hose for CNG applications where static charge buildup may occur, even if electrically conductive. Use of other Hoses in CNG applications or failure to properly connect or ground this Hose can cause a fire or an explosion resulting in death, personal injury, and property damage. Care must also be taken to protect against CNG permeation through the Hose wall. See section 2.6, Permeation, for more information. Parker CNG Hose is intended for dispenser and vehicle use within the specified temperature range. Parker CNG Hose should not be used in confined spaces or unventilated areas or areas exceeding the specified temperature range. Final assemblies must be tested for leaks. CNG Hose Assemblies should be tested on a monthly basis for conductivity per ANSI/IAS NGV 4.2; CSA 12.52.



**Parker Safety Guide, Parker Publication No. 4400-B.1** (continued)

Parker manufactures special Hose for aerospace in-flight applications. Aerospace in-flight applications employing Hose to transmit fuel, lubricating fluids and hydraulic fluids require a special Hose with a conductive inner tube. This Hose for in-flight applications is available only from Parker's Stratoflex Products Division. Do not use any other Parker Hose for in-flight applications, even if electrically conductive. Use of other Hoses for in-flight applications or failure to properly connect or ground this Hose can cause a fire or an explosion resulting in death, personal injury and property damage. These Hose assemblies for in-flight applications must meet all applicable aerospace industry, aircraft engine and aircraft requirements.

- 2.2 Pressure:** Hose, Tube and Fitting selection must be made so that the published maximum working pressure of the Hose, Tube and Fittings are equal to or greater than the maximum system pressure. The maximum working pressure of a Hose, or Tube Assembly is the lower of the respective published maximum working pressures of the Hose, Tube and the Fittings used. Surge pressures or peak transient pressures in the system must be below the published maximum working pressure for the Hose, Tube and Fitting. Surge pressures and peak pressures can usually only be determined by sensitive electrical instrumentation that measures and indicates pressures at millisecond intervals. Mechanical pressure gauges indicate only average pressures and cannot be used to determine surge pressures or peak transient pressures. Published burst pressure ratings for Hose is for manufacturing test purposes only and is no indication that the Product can be used in applications at the burst pressure or otherwise above the published maximum recommended working pressure.
- 2.3 Suction:** Hoses used for suction applications must be selected to insure that the Hose will withstand the vacuum and pressure of the system. Improperly selected Hose may collapse in suction application.
- 2.4 Temperature:** Be certain that fluid and ambient temperatures, both steady and transient, do not exceed the limitations of the Hose, Tube, Fitting and Seals. Temperatures below and above the recommended limit can degrade Hose, Tube, Fittings and Seals to a point where a failure may occur and release fluid. Tube and Fittings performances are normally degraded at elevated temperature. Material compatibility can also change at temperatures outside of the rated range. Properly insulate and protect the Hose Assembly when routing near hot objects (e.g. manifolds). Do not use any Hose in any application where failure of the Hose could result in the conveyed fluids (or vapors or mist from the conveyed fluids) contacting any open flame, molten metal, or other potential fire ignition source that could cause burning or explosion of the conveyed fluids or vapors.
- 2.5 Fluid Compatibility:** Hose, and Tube Assembly selection must assure compatibility of the Hose tube, cover, reinforcement, Tube, Plating and Seals with the fluid media used. See the fluid compatibility chart in the Parker publication for the product being considered or used. This information is offered only as a guide. Actual service life can only be determined by the end user by testing under all extreme conditions and other analysis.
- Hose, and Tube that is chemically compatible with a particular fluid must be assembled using Fittings and adapters containing likewise compatible seals. Flange or flare processes can change Tube material properties that may not be compatible with certain requirements such as NACE
- 2.6 Permeation:** Permeation (that is, seepage through the Hose or Seal) will occur from inside the Hose or Fitting to outside when Hose or Fitting is used with gases, liquid and gas fuels, and refrigerants (including but not limited to such materials as helium, diesel fuel, gasoline, natural gas, or LPG). This permeation may result in high concentrations of vapors which are potentially flammable, explosive, or toxic, and in loss of fluid. Dangerous explosions, fires, and other hazards can result when using the wrong Hose for such applications. The system designer must take into account the fact that this permeation will take place and must not use Hose or Fitting if this permeation could be hazardous. The system designer must take into account all legal, government, insurance, or any other special regulations which govern the use of fuels and refrigerants. Never use a Hose or Fitting even though the fluid compatibility is acceptable without considering the potential hazardous effects that can result from permeation through the Hose or Tube Assembly.
- Permeation of moisture from outside the Hose or Fitting to inside the Hose or Fitting will also occur in Hose or Tube assemblies, regardless of internal pressure. If this moisture permeation would have detrimental effects (particularly, but not limited to refrigeration and air conditioning systems), incorporation of sufficient drying capacity in the system or other appropriate system safeguards should be selected and used. The sudden pressure release of highly pressurized gas could also result in Explosive Decompression failure of permeated Seals and Hoses.
- 2.7 Size:** Transmission of power by means of pressurized fluid varies with pressure and rate of flow. The size of the components must be adequate to keep pressure losses to a minimum and avoid damage due to heat generation or excessive fluid velocity.

- 2.8 Routing:** Attention must be given to optimum routing to minimize inherent problems (kinking or flow restriction due to Hose collapse, twisting of the Hose, proximity to hot objects or heat sources). For additional routing recommendations see SAE J1273 and ISO 17165-2. Hose Assemblies have a finite life and should be installed in a manner that allows for ease of inspection and future replacement. Hose because of its relative short life, should not be used in residential and commercial buildings inside of inaccessible walls or floors, unless specifically allowed in the product literature. Always review all product literature for proper installation and routing instructions.
- 2.9 Environment:** Care must be taken to insure that the Hose, Tube and Fittings are either compatible with or protected from the environment (that is, surrounding conditions) to which they are exposed. Environmental conditions including but not limited to ultraviolet radiation, sunlight, heat, ozone, moisture, water, salt water, chemicals and air pollutants can cause degradation and premature failure.
- 2.10 Mechanical Loads:** External forces can significantly reduce Hose, Tube and Fitting life or cause failure. Mechanical loads which must be considered include excessive flexing, twist, kinking, tensile or side loads, bend radius, and vibration. Use of swivel type Fittings or adapters may be required to insure no twist is put into the Hose. Use of proper Hose or Tube clamps may also be required to reduce external mechanical loads. Unusual applications may require special testing prior to Hose selection.
- 2.11 Physical Damage:** Care must be taken to protect Hose from wear, snagging, kinking, bending smaller than minimum bend radius and cutting, any of which can cause premature Hose failure. Any Hose that has been kinked or bent to a radius smaller than the minimum bend radius, and any Hose that has been cut or is cracked or is otherwise damaged should be removed and discarded. Fittings with damages such as scratches on sealing surfaces and deformation should be replaced.
- 2.12 Proper End Fitting:** See instructions 3.2 through 3.5. These recommendations may be substantiated by testing to industry standards such as SAE J517 for hydraulic applications, or MIL-A-5070, AS1339, or AS3517 for Hoses from Parker's Stratoflex Products Division for aerospace applications.
- 2.13 Length:** When determining the proper Hose or Tube length of an assembly, be aware of Hose length change due to pressure, Tube length change due to thermal expansion or contraction, and Hose or Tube and machine tolerances and movement must be considered. When routing short hose assemblies, it is recommended that the minimum free hose length is always used. Consult the hose manufacturer for their minimum free hose length recommendations. Hose assemblies should be installed in such a way that any motion or flexing occurs within the same plane.
- 2.14 Specifications and Standards:** When selecting Hose, Tube and Fittings, government, industry, and Parker specifications and recommendations must be reviewed and followed as applicable.
- 2.15 Hose Cleanliness:** Hose and Tube components may vary in cleanliness levels. Care must be taken to insure that the Hose and Tube Assembly selected has an adequate level of cleanliness for the application.
- 2.16 Fire Resistant Fluids:** Some fire resistant fluids that are to be conveyed by Hose or Tube require use of the same type of Hose or Tube as used with petroleum base fluids. Some such fluids require a special Hose, Tube, Fitting and Seal, while a few fluids will not work with any Hose at all. See instructions 2.5 and 1.5. The wrong Hose, Tube, Fitting or Seal may fail after a very short service. In addition, all liquids but pure water may burn fiercely under certain conditions, and even pure water leakage may be hazardous.
- 2.17 Radiant Heat:** Hose and Seals can be heated to destruction without contact by such nearby items as hot manifolds or molten metal. The same heat source may then initiate a fire. This can occur despite the presence of cool air around the Hose or Seal. Performance of Tube and Fitting subjected to the heat could be degraded.
- 2.18 Welding or Brazing:** When using a torch or arc welder in close proximity to hydraulic lines, the hydraulic lines should be removed or shielded with appropriate fire resistant materials. Flame or weld spatter could burn through the Hose or Seal and possibly ignite escaping fluid resulting in a catastrophic failure. Heating of plated parts, including Hose Fittings and adapters, above 450°F (232°C) such as during welding, brazing or soldering may emit deadly gases. Any elastomer seal on fittings shall be removed prior to welding or brazing, any metallic surfaces shall be protected after brazing or welding when necessary. Welding and brazing filler material shall be compatible with the Tube and Fitting that are joined.
- 2.19 Atomic Radiation:** Atomic radiation affects all materials used in Hose and Tube assemblies. Since the long-term effects may be unknown, do not expose Hose or Tube assemblies to atomic radiation. Nuclear applications may require special Tube and Fittings.
- 2.20 Aerospace Applications:** The only Hose, Tube and Fittings that may be used for in-flight aerospace applications are those available from Parker's Stratoflex Products Division. Do not use any other Hose or Fittings for

A

B

C

D

E

**Parker Safety Guide, Parker Publication No. 4400-B.1** (continued)

in-flight applications. Do not use any Hose or Fittings from Parker's Stratoflex Products Division with any other Hose or Fittings, unless expressly approved in writing by the engineering manager or chief engineer of Stratoflex Products Division and verified by the user's own testing and inspection to aerospace industry standards.

**2.21 Unlocking Couplings:** Ball locking couplings or other Fittings with quick disconnect ability can unintentionally disconnect if they are dragged over obstructions, or if the sleeve or other disconnect member, is bumped or moved enough to cause disconnect. Threaded Fittings should be considered where there is a potential for accidental uncoupling.

**3.0 HOSE AND FITTINGS ASSEMBLY AND INSTALLATION INSTRUCTIONS**

**3.1 Component Inspection:** Prior to assembly, a careful examination of the Hose and Fittings must be performed. All components must be checked for correct style, size, catalog number, and length. The Hose must be examined for cleanliness, obstructions, blisters, cover looseness, kinks, cracks, cuts or any other visible defects. Inspect the Fitting and sealing surfaces for burrs, nicks, corrosion or other imperfections. Do NOT use any component that displays any signs of nonconformance.

**3.2 Hose and Fitting Assembly:** Do not assemble a Parker Fitting on a Parker Hose that is not specifically listed by Parker for that Fitting, unless authorized in writing by the engineering manager or chief engineer of the appropriate Parker division. Do not assemble a Parker Fitting on another manufacturer's Hose or a Parker Hose on another manufacturer's Fitting unless (i) the engineering manager or chief engineer of the appropriate Parker division approves the Assembly in writing or that combination is expressly approved in the appropriate Parker literature for the specific Parker product, and (ii) the user verifies the Assembly and the application through analysis and testing. For Parker Hose that does not specify a Parker Fitting, the user is solely responsible for the selection of the proper Fitting and Hose Assembly procedures. See instruction 1.4.

To prevent the possibility of problems such as leakage at the Fitting or system contamination, it is important to completely remove all debris from the cutting operation before installation of the Fittings. The Parker published instructions must be followed for assembling the Fittings on the Hose. These instructions are provided in the Parker Fitting catalog for the specific Parker Fitting being used, or by calling 1-800-CPARKER, or at [www.parker.com](http://www.parker.com).

**3.3 Related Accessories:** Do not crimp or swage any Parker Hose or Fitting with anything but the listed swage or crimp machine and dies in accordance with Parker published instructions. Do not crimp or swage another manufacturer's Fitting with a Parker crimp or swage die unless authorized in writing by the engineering manager or chief engineer of the appropriate Parker division.

**3.4 Parts:** Do not use any Parker Fitting part (including but not limited to socket, shell, nipple, or insert) except with the correct Parker mating parts, in accordance with Parker published instructions, unless authorized in writing by the engineering manager or chief engineer of the appropriate Parker division.

**3.5 Field Attachable/Permanent:** Do not reuse any field attachable Hose Fitting that has blown or pulled off a Hose. Do not reuse a Parker permanent Hose Fitting (crimped or swaged) or any part thereof. Complete Hose Assemblies may only be reused after proper inspection under section 4.0. Do not assemble Fittings to any previously used hydraulic Hose that was in service, for use in a fluid power application.

**3.6 Pre-Installation Inspection:** Prior to installation, a careful examination of the Hose Assembly must be performed. Inspect the Hose Assembly for any damage or defects. DO NOT use any Hose Assembly that displays any signs of nonconformance.

**3.7 Minimum Bend Radius:** Installation of a Hose at less than the minimum listed bend radius may significantly reduce the Hose life. Particular attention must be given to preclude sharp bending at the Hose to Fitting juncture. Any bending during installation at less than the minimum bend radius must be avoided. If any Hose is kinked during installation, the Hose must be discarded.

**3.8 Twist Angle and Orientation:** Hose Assembly installation must be such that relative motion of machine components does not produce twisting.

**3.9 Securement:** In many applications, it may be necessary to restrain, protect, or guide the Hose to protect it from damage by unnecessary flexing, pressure surges, and contact with other mechanical components. Care must be taken to insure such restraints do not introduce additional stress or wear points.

**3.10 Proper Connection of Ports:** Proper physical installation of the Hose Assembly requires a correctly installed port connection insuring that no twist or torque is transferred to the Hose when the Fittings are being tightened or otherwise during use.

**3.11 External Damage:** Proper installation is not complete without insuring that tensile loads, side loads, kinking, flattening, potential abrasion, thread damage or damage to sealing surfaces are corrected or eliminated. See instruction 2.10.

**3.12 System Checkout:** All air entrapment must be eliminated and the system pressurized to the maximum system pressure (at or below the Hose maximum working pressure) and checked for proper function and freedom from leaks. Personnel must stay out of potential hazardous areas while testing and using.

**3.13 Routing:** The Hose Assembly should be routed in such a manner so if a failure does occur, the escaping media will not cause personal injury or property damage. In addition, if fluid media comes in contact with hot surfaces, open flame or sparks, a fire or explosion may occur. See section 2.4.

**3.14 Ground Fault Equipment Protection Devices (GFEPDs): WARNING! Fire and Shock Hazard.** To minimize the danger of fire if the heating cable of a Multitube bundle is damaged or improperly installed, use a Ground Fault Equipment Protection Device. Electrical fault currents may be insufficient to trip a conventional circuit breaker.

**For ground fault protection, the IEEE 515:** ([www.ansi.org](http://www.ansi.org)) standard for heating cables recommends the use of GFEPDs with a nominal 30 milliampere trip level for "piping systems in classified areas, those areas requiring a high degree of maintenance, or which may be exposed to physical abuse or corrosive atmospheres".

**4.0 TUBE AND FITTINGS ASSEMBLY AND INSTALLATION INSTRUCTIONS**

**4.1 Component Inspection:** Prior to assembly, a careful examination of the Tube and Fittings must be performed. All components must be checked for correct style, size, material, seal, and length. Inspect the Fitting and sealing surfaces for burrs, nicks, corrosion, missing seal or other imperfections. Do NOT use any component that displays any signs of nonconformance.

**4.2 Tube and Fitting Assembly:** Do not assemble a Parker Fitting with a Tube that is not specifically listed by Parker for that Fitting, unless authorized in writing by the engineering manager or chief engineer of the appropriate Parker division. The Tube must meet the requirements specified to the Fitting.

The Parker published instructions must be followed for assembling the Fittings to a Tube. These instructions are provided in the Parker Fitting catalog for the specific Parker Fitting being used, or by calling 1-800-CPARKER, or at [www.parker.com](http://www.parker.com).

**4.3 Related Accessories:** Do not preset or flange Parker Fitting components using another manufacturer's equipment or procedures unless authorized in writing by the engineering manager or chief engineer of the appropriate Parker division. Tube, Fitting component and tooling must be checked for correct style, size and material. Operation and maintenance of Related Accessories must be in accordance with the operation manual for the designated Accessory.

**4.4 Securement:** In many applications, it may be necessary to restrain, protect, or guide the Tube to protect it from damage by unnecessary flexing, pressure surges, vibration, and contact with other mechanical components. Care must be taken to insure such restraints do not introduce additional stress or wear points.

**4.5 Proper Connection of Ports:** Proper physical installation of the Tube Assembly requires a correctly installed port connection insuring that no torque is transferred to the Tube when the Fittings are being tightened or otherwise during use.

**4.6 External Damage:** Proper installation is not complete without insuring that tensile loads, side loads, flattening, potential abrasion, thread damage or damage to sealing surfaces are corrected or eliminated. See instruction 2.10.

**4.7 System Checkout:** All air entrapment must be eliminated and the system pressurized to the maximum system pressure (at or below the Tube Assembly maximum working pressure) and checked for proper function and freedom from leaks. Personnel must stay out of potential hazardous areas while testing and using.

**4.8 Routing:** The Tube Assembly should be routed in such a manner so if a failure does occur, the escaping media will not cause personal injury or property damage. In addition, if fluid media comes in contact with hot surfaces, open flame or sparks, a fire or explosion may occur. See section 2.4.

**5.0 HOSE AND FITTING MAINTENANCE AND REPLACEMENT INSTRUCTIONS**

**5.1** Even with proper selection and installation, Hose life may be significantly reduced without a continuing maintenance program. The severity of the application, risk potential from a possible Hose failure, and experience with any Hose failures in the application or in similar applications should determine the frequency of the inspection and the replacement for the Products so that Products are replaced before any failure occurs. Certain products require maintenance and inspection per industry requirements. Failure to adhere to these requirements may lead to premature failure. A maintenance program must be established and followed by the user and, at minimum, must include instructions 5.2 through 5.7

**Parker Safety Guide, Parker Publication No. 4400-B.1** *(continued)*

- 5.2 Visual Inspection Hose/Fitting:** Any of the following conditions require immediate shut down and replacement of the Hose Assembly:
- Fitting slippage on Hose;
  - Damaged, cracked, cut or abraded cover (any reinforcement exposed);
  - Hard, stiff, heat cracked, or charred Hose;
  - Cracked, damaged, or badly corroded Fittings;
  - Leaks at Fitting or in Hose;
  - Kinked, crushed, flattened or twisted Hose; and
  - Blistered, soft, degraded, or loose cover.
- 5.3 Visual Inspection All Other:** The following items must be tightened, repaired, corrected or replaced as required:
- Leaking port conditions;
  - Excess dirt buildup;/
  - Worn clamps, guards or shields; and
  - System fluid level, fluid type, and any air entrapment.
- 5.4 Functional Test:** Operate the system at maximum operating pressure and check for possible malfunctions and leaks. Personnel must avoid potential hazardous areas while testing and using the system. See section 2.2.
- 5.5 Replacement Intervals:** Hose assemblies and elastomeric seals used on Hose Fittings and adapters will eventually age, harden, wear and deteriorate under thermal cycling and compression set. Hose Assemblies and elastomeric seals should be inspected and replaced at specific replacement intervals, based on previous service life, government or industry recommendations, or when failures could result in unacceptable downtime, damage, or injury risk. See section 1.2. Hose and Fittings may be subjected to internal mechanical and/or chemical wear from the conveying fluid and may fail without warning. The user must determine the product life under such circumstances by testing. Also see section 2.5.
- 5.6 Hose Inspection and Failure:** Hydraulic power is accomplished by utilizing high pressure fluids to transfer energy and do work. Hoses, Fittings and Hose Assemblies all contribute to this by transmitting fluids at high pressures. Fluids under pressure can be dangerous and potentially lethal and, therefore, extreme caution must be exercised when working with fluids under pressure and handling the Hoses transporting the fluids. From time to time, Hose Assemblies will fail if they are not replaced at proper time intervals. Usually these failures are the result of some form of misapplication, abuse, wear or failure to perform proper maintenance. When Hoses fail, generally the high pressure fluids inside escape in a stream which may or may not be visible to the user. Under no circumstances should the user attempt to locate the leak by “feeling” with their hands or any other part of their body. High pressure fluids can and will penetrate the skin and cause severe tissue damage and possibly loss of limb. Even seemingly minor hydraulic fluid injection injuries must be treated immediately by a physician with knowledge of the tissue damaging properties of hydraulic fluid.

If a Hose failure occurs, immediately shut down the equipment and leave the area until pressure has been completely released from the Hose Assembly. Simply shutting down the hydraulic pump may or may not eliminate the pressure in the Hose Assembly. Many times check valves, etc., are employed in a system and can cause pressure to remain in a Hose Assembly even when pumps or equipment are not operating. Tiny holes in the Hose, commonly known as pinholes, can eject small, dangerously powerful but hard to see streams of hydraulic fluid. It may take several minutes or even hours for the pressure to be relieved so that the Hose Assembly may be examined safely.

Once the pressure has been reduced to zero, the Hose Assembly may be taken off the equipment and examined. It must always be replaced if a failure has occurred. Never attempt to patch or repair a Hose Assembly that has failed. Consult the nearest Parker distributor or the appropriate Parker division for Hose Assembly replacement information.

Never touch or examine a failed Hose Assembly unless it is obvious that the Hose no longer contains fluid under pressure. The high pressure fluid is extremely dangerous and can cause serious and potentially fatal injury.

- 5.7 Elastomeric seals:** Elastomeric seals will eventually age, harden, wear and deteriorate under thermal cycling and compression set. Elastomeric seals should be inspected and replaced.
- 5.8 Refrigerant gases:** Special care should be taken when working with refrigeration systems. Sudden escape of refrigerant gases can cause blindness if the escaping gases contact the eye and can cause freezing or other severe injuries if it contacts any other portion of the body.
- 5.9 Compressed natural gas (CNG):** Parker CNG Hose Assemblies should be tested after installation and before use, and at least on a monthly basis per instructions provided on the Hose Assembly tag. The recommended procedure is to pressurize the Hose and check for leaks and to visually inspect the Hose for damage and to perform an electrical resistance test.
- Caution:** Matches, candles, open flame or other sources of ignition shall not be used for Hose inspection. Leak check solutions should be rinsed off after use.
- 6.0 HOSE STORAGE**
- 6.1 Age Control:** Hose and Hose Assemblies must be stored in a manner that facilitates age control and first-in and first-out usage based on manufacturing date of the Hose and Hose Assemblies. Unless otherwise specified by the manufacturer or defined by local laws and regulations:
- 6.1.1** The shelf life of rubber hose in bulk form or hose made from two or more materials is 28 quarters (7 years) from the date of manufacture, with an extension of 12 quarters (3 years), if stored in accordance with ISO 2230;
- 6.1.2** The shelf life of thermoplastic and polytetrafluoroethylene hose is considered to be unlimited;
- 6.1.3** Hose assemblies that pass visual inspection and proof test shall not be stored for longer than 2 years.
- 6.1.4 Storage:** Stored Hose and Hose Assemblies must not be subjected to damage that could reduce their expected service life and must be placed in a cool, dark and dry area with the ends capped. Stored Hose and Hose Assemblies must not be exposed to temperature extremes, ozone, oils, corrosive liquids or fumes, solvents, high humidity, rodents, insects, ultraviolet light, electromagnetic fields or radioactive materials.

A

B

C

D

E

<b>Issue Date</b> 24-SEP-2015	<b>ECO Number:</b> XXXXXX	<b>Revision Letter:</b> A	<b>Revision Date:</b> 30-OCT-2015	<b>Specification</b> FC-Safety Guide
----------------------------------	------------------------------	------------------------------	--------------------------------------	---

THIS DOCUMENT CONTAINS INFORMATION THAT IS CONFIDENTIAL AND PROPRIETARY TO PARKER HANNIFIN. THIS DOCUMENT IS FURNISHED ON THE UNDERSTANDING THAT THE DOCUMENT AND THE INFORMATION IT CONTAINS WILL NOT BE COPIED OR DISCLOSED TO OTHERS EXCEPT WITH THE WRITTEN CONSENT OF PARKER, WILL NOT BE USED FOR ANY PURPOSE OTHER THAN CONDUCTING BUSINESS WITH PARKER, AND WILL BE RETURNED AND ALL FURTHER USE DISCONTINUED UPON REQUEST BY PARKER. COPYRIGHT PARKER. YEAR OF COPYRIGHT IS FIRST YEAR INDICATED ON THIS DOCUMENT. ALL RIGHTS RESERVED

## Offer of Sale

- A**
1. **Definitions.** As used herein, the following terms have the meanings indicated.
- Buyer: means any customer receiving a Quote for Products from Seller.
- Goods: means any tangible part, system or component to be supplied by the Seller.
- Products: means the Goods, Services and/or Software as described in a Quote provided by the Seller.
- Quote: means the offer or proposal made by Seller to Buyer for the supply of Products.
- Seller: means Parker-Hannifin Corporation, including all divisions and businesses thereof.
- Services: means any services to be supplied by the Seller.
- Software: means any software related to the Products, whether embedded or separately downloaded.
- Terms: means the terms and conditions of this Offer of Sale or any newer version of the same as published by Seller electronically at [www.parker.com/saleterms](http://www.parker.com/saleterms).
- B**
2. **Terms.** All sales of Products by Seller are contingent upon, and will be governed by, these Terms and, these Terms are incorporated into any Quote provided by Seller to any Buyer. Buyer's order for any Products whether communicated to Seller verbally, in writing, by electronic data interface or other electronic commerce, shall constitute acceptance of these Terms. Seller objects to any contrary or additional terms or conditions of Buyer. Reference in Seller's order acknowledgement to Buyer's purchase order or purchase order number shall in no way constitute an acceptance of any of Buyer's terms of purchase. No modification to these Terms will be binding on Seller unless agreed to in writing and signed by an authorized representative of Seller.
- C**
3. **Price; Payment.** The Products set forth in Seller's Quote are offered for sale at the prices indicated in Seller's Quote. Unless otherwise specifically stated in Seller's Quote, prices are valid for thirty (30) days and do not include any sales, use, or other taxes or duties. Seller reserves the right to modify prices at any time to adjust for any raw material price fluctuations. Unless otherwise specified by Seller, all prices are F.C.A. Seller's facility (INCOTERMS 2010). All sales are contingent upon credit approval and payment for all purchases is due thirty (30) days from the date of invoice (or such date as may be specified in the Quote). Unpaid invoices beyond the specified payment date incur interest at the rate of 1.5% per month or the maximum allowable rate under applicable law.
- D**
4. **Shipment; Delivery; Title and Risk of Loss.** All delivery dates are approximate. Seller is not responsible for damages resulting from any delay. Regardless of the manner of shipment, delivery occurs and title and risk of loss or damage pass to Buyer, upon placement of the Products with the shipment carrier at Seller's facility. Unless otherwise agreed, Seller may exercise its judgment in choosing the carrier and means of delivery. No deferment of shipment at Buyers' request beyond the respective indicated shipping date will be made except on terms that will indemnify, defend and hold Seller harmless against all loss and additional expense. Buyer shall be responsible for any additional shipping charges incurred by Seller due to Buyer's acts or omissions.
- E**
5. **Warranty.** The warranty related to the Products is as follows: (i) Goods are warranted against defects in material or workmanship for a period of twelve (12) months from the date of delivery or 2,000 hours of use, whichever occurs first; (ii) Services shall be performed in accordance with generally accepted practices and using the degree of care and skill that is ordinarily exercised and customary in the field to which the Services pertain and are warranted for a period of six (6) months from the completion of the Services by Seller; and (iii) Software is only warranted to perform in accordance with applicable specifications provided by Seller to Buyer for ninety (90) days from the date of delivery or, when downloaded by a Buyer or end-user, from the date of the initial download. All prices are based upon the exclusive limited warranty stated above, and upon the following disclaimer:  
**DISCLAIMER OF WARRANTY: THIS WARRANTY IS THE SOLE AND ENTIRE WARRANTY PERTAINING TO PRODUCTS. SELLER DISCLAIMS ALL OTHER WARRANTIES, EXPRESS AND IMPLIED, INCLUDING DESIGN, NONINFRINGEMENT, MERCHANTABILITY, AND FITNESS FOR A PARTICULAR PURPOSE. SELLER DOES NOT WARRANT THAT THE SOFTWARE IS ERROR-FREE OR FAULT-TOLERANT, OR THAT BUYER'S USE THEREOF WILL BE SECURE OR UNINTERRUPTED. BUYER AGREES AND ACKNOWLEDGES THAT UNLESS OTHERWISE AUTHORIZED IN WRITING BY SELLER THE SOFTWARE SHALL NOT BE USED IN CONNECTION WITH HAZARDOUS OR HIGH RISK ACTIVITIES OR ENVIRONMENTS. EXCEPT AS EXPRESSLY STATED HEREIN, ALL PRODUCTS ARE PROVIDED "AS IS".**
6. **Claims; Commencement of Actions.** Buyer shall promptly inspect all Products upon receipt. No claims for shortages will be allowed unless reported to the Seller within ten (10) days of delivery. Buyer shall notify Seller of any alleged breach of warranty within thirty (30) days after the date the non-conformance is or should have been discovered by Buyer. Any claim or action against Seller based upon breach of contract or any other theory, including tort, negligence, or otherwise must be commenced within twelve (12) months from the date of the alleged breach or other alleged event, without regard to the date of discovery.
7. **LIMITATION OF LIABILITY.** IN THE EVENT OF A BREACH OF WARRANTY, SELLER WILL, AT ITS OPTION, REPAIR OR REPLACE THE NON-CONFORMING PRODUCT, RE-PERFORM THE SERVICES, OR REFUND THE PURCHASE PRICE PAID WITHIN A REASONABLE PERIOD OF TIME. **IN NO EVENT IS SELLER LIABLE FOR ANY SPECIAL, INDIRECT, INCIDENTAL OR CONSEQUENTIAL DAMAGES ARISING OUT OF, OR AS THE RESULT OF, THE SALE, DELIVERY, NON-DELIVERY, SERVICING, NON-COMPLETION OF SERVICES, USE, LOSS OF USE OF, OR INABILITY TO USE THE PRODUCTS OR ANY PART THEREOF, LOSS OF DATA, IDENTITY, PRIVACY, OR CONFIDENTIALITY, OR FOR ANY CHARGES OR EXPENSES OF ANY NATURE INCURRED WITHOUT SELLER'S WRITTEN CONSENT, WHETHER BASED IN CONTRACT, TORT OR OTHER LEGAL THEORY. IN NO EVENT SHALL SELLER'S LIABILITY UNDER ANY CLAIM MADE BY BUYER EXCEED THE PURCHASE PRICE PAID FOR THE PRODUCTS.**
8. **Loss to Buyer's Property.** Any designs, tools, patterns, materials, drawings, confidential information or equipment furnished by Buyer or any other items which are or become Buyer's property, will be considered obsolete and may be destroyed by Seller after two (2) consecutive years have elapsed without Buyer ordering the Products manufactured using such property. Seller shall not be responsible for any loss or damage to such property while it is in Seller's possession or control.
9. **Special Tooling.** Special Tooling includes but is not limited to tooling, jigs, fixtures and associated manufacturing equipment acquired or necessary to manufacture Products. A tooling charge may be imposed for any Special Tooling. Such Special Tooling shall be and remain Seller's property notwithstanding payment of any charges by Buyer. In no event will Buyer acquire any interest in Special Tooling belonging to Seller that is utilized in the manufacture of the Products, even if such Special Tooling has been specially converted or adapted for such manufacture and notwithstanding any charges paid by Buyer. Unless otherwise agreed, Seller has the right to alter, discard or otherwise dispose of any Special Tooling or other property in its sole discretion at any time.
10. **Security Interest.** To secure payment of all sums due, Seller retains a security interest in all Products delivered to Buyer and, Buyer's acceptance of these Terms is deemed to be a Security Agreement under the Uniform Commercial Code. Buyer authorizes Seller as its attorney to execute and file on Buyer's behalf all documents Seller deems necessary to perfect its security interest.
11. **User Responsibility.** The Buyer through its own analysis and testing, is solely responsible for making the final selection of the Products and assuring that all performance, endurance, maintenance, safety and warning requirements of the application of the Products are met. The Buyer must analyze all aspects of the application and follow applicable industry standards, specifications, and other technical information provided with the Product. If Seller provides Product options based upon data or specifications provided by the Buyer, the Buyer is responsible for determining that such data and specifications are suitable and sufficient for all applications and reasonably foreseeable uses of the Products. In the event the Buyer is not the end-user, Buyer will ensure such end-user complies with this paragraph.
12. **Use of Products, Indemnity by Buyer.** Buyer shall comply with all instructions, guides and specifications provided by Seller with the Products. **Unauthorized Uses.** If Buyer uses or resells the Products for any uses prohibited in Seller's instructions, guides or specifications, or Buyer otherwise fails to comply with Seller's instructions, guides and specifications, Buyer acknowledges that any such use, resale, or non-compliance is at Buyer's sole risk. Buyer shall indemnify, defend, and hold Seller harmless from any losses, claims, liabilities, damages, lawsuits, judgments and costs (including attorney fees and defense costs), whether for personal injury, property damage, intellectual property infringement or any other claim, brought by or incurred by Buyer, Buyer's employees, or any other person, arising out of: (a) improper selection, application, design, specification or other misuse of Products provided by Seller; (b) any act or omission, negligent or otherwise,

of Buyer; (c) Seller's use of patterns, tooling, equipment, plans, drawings, designs or specifications or other information or things furnished by Buyer; (d) damage to the Products from an external cause, repair or attempted repair by anyone other than Seller, failure to follow instructions, guides and specifications provided by Seller, use with goods not provided by Seller, or opening, modifying, deconstructing or tampering with the Products for any reason; or (e) Buyer's failure to comply with these Terms. Seller shall not indemnify Buyer under any circumstance except as otherwise provided in these Terms.

13. **Cancellations and Changes.** Buyer may not cancel or modify any order for any reason, except with Seller's written consent and upon terms that will indemnify, defend and hold Seller harmless against all direct, incidental and consequential loss or damage. Seller, at any time, may change Product features, specifications, designs and availability.
14. **Limitation on Assignment.** Buyer may not assign its rights or obligations without the prior written consent of Seller.
15. **Force Majeure.** Seller does not assume the risk and is not liable for delay or failure to perform any of Seller's obligations by reason of events or circumstances beyond its reasonable control ("Events of Force Majeure"). Events of Force Majeure shall include without limitation: accidents, strikes or labor disputes, acts of any government or government agency, acts of nature, delays or failures in delivery from carriers or suppliers, shortages of materials, or any other cause beyond Seller's reasonable control.
16. **Waiver and Severability.** Failure to enforce any provision of these Terms will not invalidate that provision; nor will any such failure prejudice Seller's right to enforce that provision in the future. Invalidation of any provision of these Terms by legislation or other rule of law shall not invalidate any other provision herein and, the remaining provisions will remain in full force and effect.
17. **Termination.** Seller may terminate any agreement governed by or arising from these Terms for any reason and at any time by giving Buyer thirty (30) days prior written notice. Seller may immediately terminate, in writing, if Buyer: (a) breaches any provision of these Terms (b) appoints a trustee, receiver or custodian for all or any part of Buyer's property (c) files a petition for relief in bankruptcy on its own behalf, or one if filed by a third party (d) makes an assignment for the benefit of creditors; or (e) dissolves its business or liquidates all or a majority of its assets.
18. **Ownership of Software.** Seller retains ownership of all Software supplied to Buyer hereunder. In no event shall Buyer obtain any greater right in and to the Software than a right in the nature of a license limited to the use thereof and subject to compliance with any other terms provided with the Software.
19. **Indemnity for Infringement of Intellectual Property Rights.** Seller is not liable for infringement of any patents, trademarks, copyrights, trade dress, trade secrets or similar rights ("Intellectual Property Rights") except as provided in this Section. Seller will defend at its expense and will pay the cost of any settlement or damages awarded in an action brought against Buyer based on a third party claim that one or more of the Products sold hereunder infringes the Intellectual Property Rights of a third party in the country of delivery of the Products by the Seller to the Buyer. Seller's obligation to defend and indemnify Buyer is contingent on Buyer notifying Seller within ten (10) days after Buyer becomes aware of any such claim, and Seller having sole control over the defense of the claim including all negotiations for settlement or compromise. If one or more Products sold hereunder is subject to such a claim, Seller may, at its sole expense and option, procure for Buyer the right to continue using the Products, replace or modify the Products so as to render them non-infringing, or offer to accept return of the Products and refund the purchase price less a reasonable allowance for depreciation. Seller has no obligation or liability for any claim of infringement: (i) arising from information provided by Buyer; or (ii) directed to any Products provided hereunder for which the designs are specified in whole or part by Buyer; or (iii) resulting from the modification, combination or use in a system of any Products provided hereunder. The foregoing provisions of this Section constitute Seller's sole and exclusive liability and Buyer's sole and exclusive remedy for such claims of infringement of Intellectual Property Rights.
20. **Governing Law.** These Terms and the sale and delivery of all Products are deemed to have taken place in, and shall be governed and construed in accordance with, the laws of the State of Ohio, as applicable to contracts executed and wholly performed therein and without regard to conflicts of laws principles. Buyer irrevocably agrees and consents to the exclusive jurisdiction and venue of the courts of Cuyahoga County, Ohio with respect to any dispute, controversy or claim arising out of or relating to the sale and delivery of the Products.
21. **Entire Agreement.** These Terms, along with the terms set forth in the main body of any Quote, forms the entire agreement between the Buyer and Seller and constitutes the final, complete and exclusive expression of the terms of sale. In the event of a conflict between any term set forth in the main body of a

Quote and these Terms, the terms set forth in the main body of the Quote shall prevail. All prior or contemporaneous written or oral agreements or negotiations with respect to the subject matter shall have no effect. These Terms may not be modified unless in writing and signed by an authorized representative of Seller.

22. **Compliance with Laws.** Buyer agrees to comply with all applicable laws, regulations, and industry and professional standards, including those of the United States of America, and the country or countries in which Buyer may operate, including without limitation the U.S. Foreign Corrupt Practices Act ("FCPA"), the U.S. Anti-Kickback Act ("Anti-Kickback Act"), U.S. and E.U. export control and sanctions laws ("Export Laws"), the U.S. Food Drug and Cosmetic Act ("FDCA"), and the rules and regulations promulgated by the U.S. Food and Drug Administration ("FDA"), each as currently amended. Buyer agrees to indemnify, defend, and hold harmless Seller from the consequences of any violation of such laws, regulations and standards by Buyer, its employees or agents. Buyer acknowledges that it is familiar with all applicable provisions of the FCPA, the Anti-Kickback Act, Export Laws, the FDCA and the FDA and certifies that Buyer will adhere to the requirements thereof and not take any action that would make Seller violate such requirements. Buyer represents and agrees that Buyer will not make any payment or give anything of value, directly or indirectly, to any governmental official, foreign political party or official thereof, candidate for foreign political office, or commercial entity or person, for any improper purpose, including the purpose of influencing such person to purchase Products or otherwise benefit the business of Seller. Buyer further represents and agrees that it will not receive, use, service, transfer or ship any Product from Seller in a manner or for a purpose that violates Export Laws or would cause Seller to be in violation of Export Laws.

A

B

C

D

E



# Parker's Motion & Control Technologies

*At Parker, we're guided by a relentless drive to help our customers become more productive and achieve higher levels of profitability by engineering the best systems for their requirements. It means looking at customer applications from many angles to find new ways to create value. Whatever the motion and control technology need, Parker has the experience, breadth of product and global reach to consistently deliver. No company knows more about motion and control technology than Parker. For further info call 1 800 C-Parker (1 800 272 7537)*



## **Aerospace**

### **Key Markets**

Aftermarket services  
Commercial transports  
Engines  
General & business aviation  
Helicopters  
Launch vehicles  
Military aircraft  
Missiles  
Power generation  
Regional transports  
Unmanned aerial vehicles

### **Key Products**

Control systems & actuation products  
Engine systems & components  
Fluid conveyance systems & components  
Fluid metering, delivery & atomization devices  
Fuel systems & components  
Fuel tank inerting systems  
Hydraulic systems & components  
Thermal management  
Wheels & brakes



## **Climate Control**

### **Key Markets**

Agriculture  
Air conditioning  
Construction Machinery  
Food & beverage  
Industrial machinery  
Life sciences  
Oil & gas  
Precision cooling  
Process  
Refrigeration  
Transportation

### **Key Products**

Accumulators  
Advanced actuators  
CO<sub>2</sub> controls  
Electronic controllers  
Filter driers  
Hand shut-off valves  
Heat exchangers  
Hose & fittings  
Pressure regulating valves  
Refrigerant distributors  
Safety relief valves  
Smart pumps  
Solenoid valves  
Thermostatic expansion valves



## **Electromechanical**

### **Key Markets**

Aerospace  
Factory automation  
Life science & medical  
Machine tools  
Packaging machinery  
Paper machinery  
Plastics machinery & converting  
Primary metals  
Semiconductor & electronics  
Textile  
Wire & cable

### **Key Products**

AC/DC drives & systems  
Electric actuators, gantry robots & slides  
Electrohydraulic actuation systems  
Electromechanical actuation systems  
Human machine interface  
Linear motors  
Stepper motors, servo motors, drives & controls  
Structural extrusions



## **Filtration**

### **Key Markets**

Aerospace  
Food & beverage  
Industrial plant & equipment  
Life sciences  
Marine  
Mobile equipment  
Oil & gas  
Power generation & renewable energy  
Process  
Transportation  
Water Purification

### **Key Products**

Analytical gas generators  
Compressed air filters & dryers  
Engine air, coolant, fuel & oil filtration systems  
Fluid condition monitoring systems  
Hydraulic & lubrication filters  
Hydrogen, nitrogen & zero air generators  
Instrumentation filters  
Membrane & fiber filters  
Microfiltration  
Sterile air filtration  
Water desalination & purification filters & systems



## **Fluid & Gas Handling**

### **Key Markets**

Aerial lift  
Agriculture  
Bulk chemical handling  
Construction machinery  
Food & beverage  
Fuel & gas delivery  
Industrial machinery  
Life sciences  
Marine  
Mining  
Mobile  
Oil & gas  
Renewable energy  
Transportation

### **Key Products**

Check valves  
Connectors for low pressure fluid conveyance  
Deep sea umbilicals  
Diagnostic equipment  
Hose couplings  
Industrial hose  
Mooring systems & power cables  
PTFE hose & tubing  
Quick couplings  
Rubber & thermoplastic hose  
Tube fittings & adapters  
Tubing & plastic fittings



## **Hydraulics**

### **Key Markets**

Aerial lift  
Agriculture  
Alternative energy  
Construction machinery  
Forestry  
Industrial machinery  
Machine tools  
Marine  
Material handling  
Mining  
Oil & gas  
Power generation  
Refuse vehicles  
Renewable energy  
Truck hydraulics  
Turf equipment

### **Key Products**

Accumulators  
Cartridge valves  
Electrohydraulic actuators  
Human machine interfaces  
Hybrid drives  
Hydraulic cylinders  
Hydraulic motors & pumps  
Hydraulic systems  
Hydraulic valves & controls  
Hydrostatic steering  
Integrated hydraulic circuits  
Power take-offs  
Power units  
Rotary actuators  
Sensors



## **Pneumatics**

### **Key Markets**

Aerospace  
Conveyor & material handling  
Factory automation  
Life science & medical  
Machine tools  
Packaging machinery  
Transportation & automotive

### **Key Products**

Air preparation  
Brass fittings & valves  
Manifolds  
Pneumatic accessories  
Pneumatic actuators & grippers  
Pneumatic valves & controls  
Quick disconnects  
Rotary actuators  
Rubber & thermoplastic hose & couplings  
Structural extrusions  
Thermoplastic tubing & fittings  
Vacuum generators, cups & sensors



## **Process Control**

### **Key Markets**

Alternative fuels  
Biopharmaceuticals  
Chemical & refining  
Food & beverage  
Marine & shipbuilding  
Medical & dental  
Microelectronics  
Nuclear Power  
Offshore oil exploration  
Oil & gas  
Pharmaceuticals  
Power generation  
Pulp & paper  
Steel  
Water/wastewater

### **Key Products**

Analytical Instruments  
Analytical sample conditioning products & systems  
Chemical injection fittings & valves  
Fluoropolymer chemical delivery fittings, valves & pumps  
High purity gas delivery fittings, valves, regulators & digital flow controllers  
Industrial mass flow meters/ controllers  
Permanent no-weld tube fittings  
Precision industrial regulators & flow controllers  
Process control double block & bleeds  
Process control fittings, valves, regulators & manifold valves



## **Sealing & Shielding**

### **Key Markets**

Aerospace  
Chemical processing  
Consumer  
Fluid power  
General industrial  
Information technology  
Life sciences  
Microelectronics  
Military  
Oil & gas  
Power generation  
Renewable energy  
Telecommunications  
Transportation

### **Key Products**

Dynamic seals  
Elastomeric o-rings  
Electro-medical instrument design & assembly  
EMI shielding  
Extruded & precision-cut, fabricated elastomeric seals  
High temperature metal seals  
Homogeneous & inserted elastomeric shapes  
Medical device fabrication & assembly  
Metal & plastic retained composite seals  
Shielded optical windows  
Silicone tubing & extrusions  
Thermal management  
Vibration dampening

**ENGINEERING YOUR SUCCESS.**

# Parker Fluid Connectors Group

## North American Divisions & Distribution Service Centers

**Your complete source** for quality tube fittings, hose & hose fittings, brass & composite fittings, quick-disconnect couplings, valves and assembly tools, locally available from a worldwide network of authorized distributors.

### **Fittings:**

Available in inch and metric sizes covering SAE, BSP, DIN, GAZ, JIS and ISO thread configurations, manufactured from steel, stainless steel, brass, aluminum, nylon and thermoplastic.

### **Hose, Tubing and Bundles:**

Available in a wide variety of sizes and materials including rubber, wire-reinforced, thermoplastic, hybrid and custom compounds.

### **Worldwide Availability:**

Parker operates Fluid Connectors manufacturing locations and sales offices throughout North America, South America, Europe and Asia-Pacific.

**For information**, call toll free...

**1-800-C-PARKER**  
**(1-800-272-7537)**

## **North American Divisions**

### **Fluid System Connectors Division**

Otsego, MI  
phone 269 694 9411  
fax 269 694 4614

### **Hose Products Division**

Wickliffe, OH  
phone 440 943 5700  
fax 440 943 3129

### **Parflex Division**

Ravenna, OH  
phone 330 296 2871  
fax 330 296 8433

### **Quick Coupling Division**

Minneapolis, MN  
phone 763 544 7781  
fax 763 544 3418

### **Tube Fittings Division**

Columbus, OH  
phone 614 279 7070  
fax 614 279 7685

## **Distribution Service Centers**

### **Buena Park, CA**

phone 714 522 8840  
fax 714 994 1183

### **Louisville, KY**

phone 502 937 1322  
fax 502 937 4180

### **Portland, OR**

phone 503 283 1020  
fax 503 283 2201

### **Toledo, OH**

phone 419 878 7000  
fax 419 878 7001  
fax 419 878 7420  
(FCG Kit Operations)

### **Canada**

#### **Milton, ONT**

phone 905 693 3000  
fax 905 876 1958  
(Contact Milton for other Service Center locations.)

### **Mexico**

#### **Toluca, MEX**

phone (52) 722 2754 200  
fax (52) 722 2722 168



Parker Hannifin Corporation

### **Hose Products Division**

30240 Lakeland Boulevard

Wickliffe, OH 44092

phone 440 943 5700

fax 440 943 3129

e-mail [HPD.Support@Support.parker.com](mailto:HPD.Support@Support.parker.com)

[www.parkerhose.com](http://www.parkerhose.com)